



# DEPARTMENT OF THE NAVY (DON) FALL-PROTECTION GUIDE

July 2017

July 2017

# TABLE OF CONTENTS

<u>SECTION #</u>		<u>PAGE #</u>
	TABLE OF CONTENTS-----	2
1.0	INTRODUCTION -----	8
1.1	PURPOSE -----	8
1.2	BACKGROUND -----	8
1.3	APPLICATION -----	9
1.4	SCOPE -----	9
1.5	NAVY/MARINE CORPS FALL PROTECTION POLICY	10
1.6	ACTIVITY FALL PROTECTION POLICY -----	11
1.7	THRESHOLD HEIGHT REQUIREMENTS FOR FALL PROTECTION -----	11
1.8	COMPLIANCE -----	12
1.9	COMPARISON AMONG OSHA STANDARDS, NAVY/MARINE CORPS AND USACE EM 385 FP REQUIREMENTS-----	13
1.10	INSTRUCTIONS, REGULATIONS AND STANDARDS --	13
2.0	DEFINITIONS -----	15
3.0	FALL PROTECTION PROGRAM -----	32
3.1	COMPONENTS OF A FALL PROTECTION PROGRAM -----	32
3.2	SAMPLE WRITTEN FP PROGRAM -----	33
3.3	FP PROGRAM COMPLIANCE AUDIT CHECKLIST----	38
3.4	STEP BY STEP HOW TO ESTABLISH, MANAGE AND IMPLEMENT A FP PROGRAM -----	46
3.5	Audits and Evaluation -----	46
4.0	DUTIES AND RESPONSIBILITIES -----	47
4.1	QUALIFIED PERSON FOR FP-----	47
4.2	COMPETENT PERSON FOR FP-----	47
4.3	FP PROGRAM MANAGER -----	48
5.0	WORKPLACE SURVEYS AND ASSESSMENT OF --- FALL HAZARDS	49
5.1	FALL HAZARD SURVEY -----	49
5.2	FALL HAZARD ASSESSMENT -----	50
5.3	REQUIREMENTS FOR FALL HAZARD SURVEY REPORT-----	50
5.4	SAMPLE FALL HAZARD SURVEY REPORT -----	52
5.5	SITE SPECIFIC FALL HAZARD SURVEY REPORT	

	CHECKLIST-----	55
6.0	TRAINING -----	56
6.1	TRAINING REQUIREMENTS -----	56
6.2	TRAINING MATRIX -----	58
6.3	REFRESHERS/UPDATE TRAINING-----	65
6.4	RETRAINING -----	65
6.5	AVAILABLE WEB-BASED FP TRAINING COURSES--	65
6.6	FALL PROTECTION TRAINING ROSTER -----	67
6.7	FALL PROTECTION TRAINING ROSTER FORM -----	68
7.0	FALL HAZARD PREVENTION AND CONTROLS -----	69
7.1	PREFERRED ORDER OF CONTROL MEASURES ----	69
7.2	FALL PROTECTION AND PREVENTION PLANS -----	70
7.2.1	FALL PROTECTION AND PREVENTION PLAN REQUIREMENTS -----	70
7.2.2	INSTRUCTIONS FOR PREPARING THE PLAN-----	71
7.2.3	SAMPLE FALL PROTECTION AND PREVENTION PLAN (FORM) -----	73
7.2.4	SITE SPECIFIC FALL PROTECTION AND PREVENTION PLAN CHECKLIST -----	75
7.2.5	WHEN A COMPETENT OR QUALIFIED PERSON IS REQUIRED TO DEVELOP FP&PP -----	76
8.0	FALL PROTECTION SYSTEMS, CRITERIA AND DESIGN REQUIREMENTS -----	79
8.1	FALL PROTECTION SYSTEMS -----	79
8.2	FALL PROTECTION SYSTEM, CRITERIA AND ----- REQUIREMENTS	80
8.2.1	PREVENTION SYSTEMS -----	80
8.2.1.1	GUARDRAIL SYSTEM -----	80
8.2.1.2	PARAPETS -----	86
8.2.1.3	COVERS -----	87
8.2.1.4	SAFETY NETS -----	90
8.2.2	ACTIVE FALL PROTECTION SYSTEMS-----	91
8.2.2.1	FALL ARREST SYSTEM -----	91
8.2.2.2	FALL ARREST SYSTEM REQUIREMENTS-----	93
8.2.2.3	FALL ARREST SYSTEM, SUBSYSTEMS AND COMPONENTS -----	94
8.2.3	OTHER ACTIVE FALL PROTECTION SYSTEMS -----	122
8.2.3.1	FELXIBLE HORIZONTAL LIFELINE SYSTEM-----	122
8.2.3.2	RIGID HORIZONTAL RAIL SYSTEM-----	125
8.2.3.3	SINGLE ANCHOR VERTICAL LIFELINE SYSTEM-----	126
8.2.3.4	CLIMBING LADDER FA SYSTEM -----	128
8.2.3.5	RESTRAINT SYSTEM -----	130

8.2.4	OTHER FALL PROTECTION SYSTEMS -----	131
8.2.4.1	POSITIONING SYSTEM -----	131
8.2.4.2	WARNING LINE SYSTEM -----	132
8.2.4.3	DESIGNATED AREA -----	133
8.2.4.4	OTHER ENGINEERED FP SYSTEMS-----	134
8.2.4.5	SUSPENDED ROPE ACCESS -----	135
8.2.4.6	LADDER CAGES -----	136
8.2.5	PROHIBITED FALL PROTECTION SYSTEMS -----	136
8.2.5.1	SAFETY MONITORING SYSTEM -----	136
8.2.5.2	CONTROLLED ACCESS ZONE -----	137
9.0	FALL PROTECTION FOR SPECIFIC WORK APPLICATIONS -----	138
9.1	REQUIREMENTS FOR ROOF WORK -----	138
9.1.1	GENERAILED INDUSTRY WORK (FINAL RULE) -----	138
9.1.2	CONSTRUCTION WORK -----	139
9.2	INSEPECTION, INVESTIGATION AND ASSESSMENT WORK (GENERAL INDUSTRY -----	140
9.3	COMMUNICATION TOWERS -----	141
9.4	TOWER ERECTION -----	142
9.5	LEADING EDGE WORK -----	143
9.6	SCAFFOLD WORK -----	143
9.7	SUSPENDED SCAFFOLDS -----	143
9.8	WORK-STANDS, STATIONARY WORK PLATFORMS AND CATWALKS -----	144
9.9	AERIAL WORK PLATFORMS -----	144
9.9.1	AERIAL LIFT EQUIPMENT-----	145
9.9.2	SCISSOR LIFTS -----	146
9.9.3	MOBILE SCAFFOLDS -----	146
9.9.4	SAFETY OPERATING PROCEDURES FOR PREVENTING AWP FROM TIPPING OVER -----	146
9.9.5	TYPES OF AERIAL WORK PLATFORMS -----	147
9.10	CONFINED SPACE ENTRY -----	150
9.11	EXCAVATED TRENCHES OR HOLES MORE THAN SIX FEET DEEP -----	150
9.12	SAFE WORK PRACTICES ON LADDERS AND STAIRWAYS -----	151
9.12.1	PORTABLE AND FIXED LADDERS -----	151
9.12.2.	PORTABLE LADDERS-SELF SUPPORTING -----	155
9.12.3	STAIRWAYS -----	156
9.13	WORKING NEAR WALL OPENINGS -----	157
9.14	CLIMBING AND WORKING ON WOOD POLES-----	157
9.14.1	METHODS OF INPECTING AND TESTING WOOD POLES -----	159
9.15	WORKING OVER WATER -----	160

9.16	AIRCRAFT MAINTENANCE -----	162
9.17	ELEVATED WORK AREA NEAR GUARDRAIL -----	162
10.0	GUIDANCE FOR RESCUE PROCEDURES -----	163
10.1	INTRODUCTION -----	163
10.2	BACKGROUND -----	163
10.3	GENERAL REQUIREMENTS -----	164
10.4	INITIATION OF RESCUE -----	164
10.5	FALL ARREST RESCUE PLANS AND PROCEDURES--	165
10.6	RESCUE EQUIPMENT INSPECTION -----	166
10.7	TRAINING REQUIREMENTS FOR RESCUE -----	166
10.8	PROCEDURES FOR REQUESTING RESCUE AND MEDICAL ASSISTANCE -----	167
10.9	TRANSPORTATION ROUTES TO A MEDICAL FACILITY-----	167
10.10	ANCHORAGES USED FOR RESCUE -----	167
10.11	SELECTIVE RESCUE EQUIPMENT AND SYSTEMS ---	168
10.12	REFERENCES RELATED TO RESCUE -----	171
10.13	FALL ARREST RESCUE PLANS -----	171
10.14	SAMPLE FALL-ARREST RESCUE PLAN (FORM) -----	173
10.15	SITE SPECIFIC FALL ARREST RESCUE PLAN (CHECKLIST) -----	175
11.0	INSPECTION, STORAGE, MAINTENANCE AND CARE PROCEDURES FOR FP EQUIPMENT -----	176
11.1	SPECIFIC EQUIPMENT INSPECTION -----	177
11.2	ADDITIONAL INSTRUCTIONS FOR ASSEMBLY, DISASSEMBLY, STORAGE, INSPECTION, CARE AND MAINTENANCE -----	183
11.3	FALL PROTECTION EQUIPMENT INSPECTION CHECKLIST -----	185
11.4	FALL-ARREST SYSTEM AND EQUIPMENT CHECKLIST -----	187
12.0	TIE-OFF CONSIDERATIONS AND SELECTION OF SAFE ANCHORAGES AND RE-CERTIFICATION OF ACTIVE FP SYSTEMS -----	192
13.0	RESPONSIBILITY FOR DESIGN, INSPECTION, CERTIFICATION AND RE-CERTIFICATION OF ANCHORAGES -----	196
13.1	RESPONSIBILITY OF ANCHORAGE IDENTIFICATION, DESIGN AND CERTIFICATION ----	196
13.2	INSPECTION, CERTIFICATION, RE-CERTIFICATION OF ANCHORAGES -----	197

14.0	FALL PREVENTION CONSIDERATIONS DURING PLANNING AND DESIGN PHASE -----	199
14.1	INTRODUCTION -----	199
14.2	PLANNING AND DESIGN CONSIDERATIONS -----	200
14.3	FALL HAZARD IDENTIFICATION-----	201
14.4	RISK ASSESSMENT -----	202
14.5	RISK CONTROL -----	202
14.6	HIERARCHY OF CONTROL MEASURES FOR PLANNING AND DESIGN -----	203
14.7	APPLICABILITY OF UNIFIED FACILITIES GUIDE SPECIFICATIONS TO FALL PROTECTION -----	203
15.0	GUIDANCE – FALL PROTECTION FOR AIRCRAFT MAINTENANCE AND INSPECTION WORK -----	205
15.1	INTRODUCTION -----	205
15.2	APPLICABILITY -----	205
15.3	PURPOSE -----	205
15.4	APPLICABLE STANDARDS, REGULATIONS/SOP AND INSTRUCTIONS -----	205
15.5	WRITTEN FALL PROTECTION PROGRAM -----	205
15.6	DUTIES AND RESPONSIBILITIES -----	206
15.7	WORKPLACE SURVEYS AND ASSESSMENT OF FALL HAZARDS -----	208
15.8	TRAINING -----	209
15.9	FALL PROTECTION SYSTEMS AND EQUIPMENT USED FOR AIRCRAFT MAINTENANCE AND INSPECTION WORK -----	209
15.10	ADMINISTRATIVE CONTROLS -----	223
15.11	INSPECTION, STORAGE, CARE AND MAINTENANCE OF FALL PROTECTION EQUIPMENT -----	224
15.12	RESCUE PROCEDURES -----	224
15.13	AUDITS AND EVALUATIONS -----	224
15.14	FUNDING AND PROCUREMENT OF FP EQUIPMENT--	224
15.15	CNAF MESSAGE -----	226
15.16	FALL PROTECTION FORMS/CHECKLISTS-----	229
15.17	EXAMPLES OF FALL PROGRAM DOCUMENTS (TEMPLATES) -----	233

16.0	FALL PROTECTION REQUIREMENTS FOR A/Es AND OTHER INSPECTORS CONDUCTING INSPECTION, INVESTIGATION AND ASSESSMENT WORK OF ROOFS, GENERAL INDUSTRY WORKPLACE CONDITIONS OR CONDUCTING FALL HAZARD SURVEYS -----	240
17.0	OTHER FALL PROTECTION MEASURES -----	254
18.0	ANSI Z359 FALL PROTECTION CODE/STANDARDS--	258
19.0	REFERENCES/HOW TO ACQUIRE INFORMATION ----	260
APPENDIX A	FALL PROTECTION REQUIREMENTS - COMPARISON AMONG VARIOUS OSHA STANDARDS, DON and EM-385 REQUIREMENTS -----	262
APPENDIX B	TOTAL FALL DISTANCE -----	278
	B.1 CALCULATING TOTAL FALL DISTANCE -----	278
	B.2 CALCULATING THE REQUIRED CLEARANCE -----	278
	B.3 SCHEMATICS FOR CALCULATING THE REQUIRED CLEARANCE -----	279
	B.4 TOTAL FALL DISTANCE SCHEMATICS -----	280
APPENDIX C	DISCUSSION, EXAMPLES/PROBLEMS AND SOLUTIONS TO FALL HAZARDS -----	283
APPENDIX D	MAN OVERBOARD PLAN -----	289
APPENDIX E	GUIDANCE DOCUMENT - DESIGN CONSIDERATIONS FOR MANAGEMENT OF FALL HAZARDS -----	293
APPENDIX F	FALL PROTECTION TRAINING COURSE SYLLABUS FOR COMPETENT PERSON -----	319
APPENDIX G	HUMAN SYSTEM INTERFACE WITH PERSONAL FALL ARREST SYSTEM -----	330
APPENDIX H	FIXED METAL LADDER INSPECTION CHECKLIST ----	333
APPENDIX I	FALL HAZARD SURVEY REPORT TEMPLATE ----- FOR SQUADRONS	337

July 2017

# **DON FALL PROTECTION GUIDE FOR NAVY AND MARINE CORPS FACILITIES**

## **1.0 INTRODUCTION**

### **1.1 PURPOSE**

This Guide provides criteria, best practices and applications in accordance with (IAW) requirements prescribed in OPNAVINST 5100.23 for developing and managing Fall Protection programs to protect all personnel (military and DON civilians) at Navy and Marine Corps Activities.

### **1.2 BACKGROUND**

Falls from heights are a leading cause of work-related injuries and fatalities. They are the leading cause in construction and the second most common cause in general industry. The DON continues to experience serious fall related mishaps, which lead to reduced readiness and productivity, as well as high medical and compensation costs resulting from these mishaps and suffering to victims and their families.

According to Bureau of Labor Statistics (BLS), there were 793 fatalities due to slips, trips and falls in 2014, accounting for approximately 17% of total work fatalities. Falls to lower level totaled 647 fatalities and falls on the same level accounted for 129 fatalities. In the United States, three to four fatalities from falls occur each working day. Furthermore, thousands of workers suffer injuries due to falls with lost time from work. Half of fall fatalities occurred in the construction industry.

BLS data shows that fall fatalities from roofs are the most common, followed by falls from ladders, scaffolds, staging, and other surfaces. Aside from tragic loss of life and suffering to victims and their families, workers are very expensive to train to perform work efficiently. On the average, a single fall fatality costs approximately \$800,000 to \$2,400,000 (in 2014 dollars, from the latest data available). The average cost of a single injury due to a fall is over \$30,000. Additionally, exposure to fall hazards is the most cited violation by Occupational Safety and Health Administration (OSHA). The intent of this guide is to establish criteria, requirements and best practices for developing and managing Fall Protection programs in order to heighten awareness and protect all DON personnel exposed to Fall-Hazards in the workplace. Falls are preventable. Careful planning and preparation lay the necessary groundwork for an accident-free workplace.



In the Department of the Navy there were 6 fall fatalities between 2009 and 2014. Between 2005 and 2014 there were 235 DON personnel who experienced falls while working on aircraft and sustained injury. Falls represented 19% of Marine Aviation Maintainer Injuries and 17% of Navy Aviation Maintainer Injuries.

### **1.3 APPLICATION**

This guide applies to all Navy and Marine Corps Activities where there is a need for developing and implementing a Fall Protection program to ensure the safety of all personnel (military and DON Civilians) worldwide. When the word personnel is used in this guide it refers to Navy and Marine Corps military and civilian personnel. It provides information on standards, regulations, formal criteria, requirements and best practices, for the protection of personnel and workers working at heights and exposed to Fall-Hazards.

#### **NOTE:**

Fall Protection Program requirements for Afloat Units are prescribed in OPNAVINST 5100.19 Series

### **1.4 SCOPE**

The scope of this guide is to develop a managed Fall Protection program and to provide the requirements and criteria for Fall Protection for potentially affected workers exposed to Fall-Hazards while conducting work at heights at US Navy and Marine Corps Activities.

This guide provides:

- a. Definitions applicable to Fall Protection and rescue.
- b. Criteria and requirements for developing a managed Fall Protection program, a sample of a written program, program compliance audit checklist and a step by step procedures how to establish, manage and implement a fall protection program.
- c. The duties, responsibilities, and qualifications of personnel involved in the managed Fall Protection program.
- d. The requirements and instructions for conducting Fall-Hazard surveys and the assessment process including the preparation of Fall-Hazard survey report.
- e. The training requirements for all personnel involved in the Fall Protection program including methods of training, refresher/update training, re-training, available web based training courses and fall protection training roster.
- f. Fall-Hazard prevention and controls including the preferred order of control measures or the hierarchy of controls, Fall Protection and prevention plan criteria, requirements and instructions, sample of the plan, and site specific plan checklist.
- g. Various Fall Protection systems, criteria and design requirements.
- h. The Fall Protection guidelines for specific common working conditions and applications (Working on roofs, communication towers, scaffolds, aircraft, etc.).

- i. Guidance for fall rescue procedures, rescue equipment inspection, training requirements for rescue, selective rescue equipment and systems and a sample rescue plan for Fall-Hazard control and a site specific fall arrest rescue plan checklist.
- j. Requirements for Fall Protection equipment inspection, maintenance, storage, and care procedures including equipment inspection checklist and fall arrest system and equipment inspection checklist.
- k. Tie-off considerations and selections of safe anchorages.
- l. Responsibility for design, inspection, certification and re-certification of anchorages and active fall protection systems.
- m. Fall Prevention considerations for management of fall hazards and responsibilities of architects and engineers during planning, design, construction, operations and maintenance activities.
- n. Fall Protection guidelines for aircraft maintenance and inspection work.
- o. Fall Protection requirements for architects/engineers and other inspectors conducting inspection, investigation and assessment work on roofs.
- p. Other fall protection measures including falling object protection, hard hats, lock-out tag-out, etc.
- q. Information regarding American National Standards Institute (ANSI), ANSI Z359 series Fall Protection Code and Standards.

## **1.5 NAVY AND MARINE CORPS FALL PROTECTION POLICY**

According to OPNAVINST 5100.23 Series, Navy Safety and Occupational Health Program Manual, Chapter 13 and MCO 5100.29B Marine Corps Safety Program and NAVMC DIR 5100.8, Marine Corps OSH Manual, every Navy and Marine Corps Command/Activity having personnel working at height, exposed to Fall-Hazards and using Fall Protection equipment is responsible for establishing, implementing and managing a Fall Protection program, which includes identification, elimination, prevention or control of Fall-Hazards. Navy and Marine Corps activities are responsible for: assigning responsibilities; surveying and assessing fall hazards; providing prevention and control measures; training of personnel; proper installation and use of fall protection systems and equipment; and the availability of rescue equipment with accompanying rescue procedures; inspecting the equipment and auditing and evaluation of the program;. Fall protection must be provided to Navy civilians and military personnel exposed to fall hazards on any elevated walking working surface with unprotected sides, edges, roofs, or floor openings, from which there is a possibility of falling **four feet or more** (5 feet for Shipyard Operations) to a lower level; or where there is a possibility of a **fall from any height** onto dangerous equipment, into a hazardous environment, or onto an impalement hazard.

- a. The Regional Commander, Commanding Officer, Director or Officer-In-Charge of the Navy Activity as well as Marine Corps Major Commands and Subordinate Commands are responsible for establishing, managing and implementing a Fall Protection program.
- b. The DON Fall Protection Working Group shall serve as the fall protection technical and policy advisor regarding the prevention of falls when working at heights and on the same level. The FPWG shall provide tools, criteria and safe work practices to ensure Naval

activities establish and manage viable fall protection programs. The Fall Protection Working Group shall meet semiannually.

- c. Naval Facilities Engineering Command is the designated Technical Warrant Holder for fall protection.
- d. Naval Sea Systems Command SEA 05 is designated the Technical Warrant Holder for shipboard fall protection systems.
- e. For Aviation, Technical Warrant Holders are spread across various PMAs under NAVAIR, based on equipment and type/model/series of aircraft.

## **1.6 ACTIVITY FALL PROTECTION POLICY**

Each activity may prescribe supplementary requirements for special conditions above and beyond the Navy and Marine Corps policy stated in paragraph 1.5 above. Development of an activity policy statement will provide general guidance and requirements and delineate responsibilities at the Command. The activity policy shall emphasize management commitment to provide a safe work environment for all personnel working at heights and that safety of personnel during performance of their work is of the utmost importance.

## **1.7 THRESHOLD HIEGHT REQUIREMENTS FOR FALL PROTECTION**

The threshold limit for providing Fall Protection is mandated by OPNAVINST 5100.23 Series, Marine Corps 5100.29 Series and the US Code of Federal Regulations (CFR).

**The standard Fall Protection threshold height for DON personnel (worldwide) is 4 feet as per OPNAVINST 5100.23 Series, MCO 5100.29 Series and the General Industry Standards, 29 CFR 1910, Subpart “D” and the 29 CFR 1910 (17 November 2016) Final Rule .**

At construction sites, workers (**contractors only**) shall adhere to the threshold height no greater than 6 feet, as per US Army Corps of Engineers (USACE), Safety and Health Requirements Manual EM 385-1-1, and 29 CFR 1926.500, Subpart ‘M’, Fall Protection in Construction Industry. When Navy and Marine Corps personnel visit construction sites to inspect contractor’s work, they may comply with the 6 foot threshold height because it would be infeasible to install guardrails at 4 foot height just for Navy and Marine Corps Personnel, when the OSHA Standards require a 6 foot threshold height for construction workers.

**For information only, the following is a table indicating the threshold limit for various industries, standards, regulations and instructions:**

<b><u>Industry</u></b>	<b><u>Feet</u></b>	<b><u>Standard, Regulation Source</u></b>
------------------------	--------------------	---

July 2017

Contractors Construction	6	EM 385-1-1 29 CFR 1926.500
General Industry	4	29 CFR 1910.23
Shipyard (Non- Ashore work)	5	29 CFR 1915.159
Marine Terminals/ Long-Shoring	4	29 CFR 1917.112
	8	29 CFR 1918

DON activities may prescribe more stringent threshold requirements for federal employees as required, due to the site-specific facility needs.

## 1.8 COMPLIANCE

29 CFR 1960.16 and Section 19 of the Occupational Safety and Health Act (OSH Act) of 1970 and Executive Order 12196 prescribe requirements for federal employment occupational safety and health programs and contains provisions to assure safe and healthful working conditions for federal employees.

Under Section 19 of OSHA Act and 29 CFR 1960.16, (for Federal Agencies), Occupational Safety and Health (OSH) programs shall be consistent and in compliance with the standards promulgated under Section 6 of the OSH Act of 1970. Section 6 of OSH Act directed by rule the Secretary of Labor to promulgate the Occupational Health and Safety Standard 29 CFR 1910.

Navy and Marine Corps personnel shall comply with the 29 CFR 1910 (1970) requirement of four feet as stated under Subpart D, Walking-Working Surfaces, OPNAVINST 5100.23 and 29 CFR 1910 (November 2016) Requirements for Walking Working Surfaces and Personal Fall Protection Systems, unless there are other alternate promulgated standards that are more specific to an Activity, Command or industry, such as the six-foot requirement for DON contractors performing construction and demolition work. Any deviation from the 4-foot threshold height shall be approved by the Command Competent Person.

Therefore, Fall Protection must be provided to DON civilians and military personnel exposed to Fall-Hazards on any elevated walking/working surface with unprotected sides, edges, or floor openings from which there is a possibility of falling 4 FEET or more to lower level including working from fixed ladders; or where there is a possibility of a fall from any height, onto dangerous equipment, into hazardous environment or onto an impalement hazard.

### NOTE:

Exceptions: (1) When climbing OSHA compliant ladders, or (2) when erecting or dismantling supported scaffolds when it is determined by a Competent Person after conducting an evaluation, that providing Fall Protection is not feasible or

July 2017

creates a greater hazard (for example: When it is necessary to erect scaffolding before erection of the structure, and requiring the scaffold structure to be erected or put in place.)

Department of Defense Instruction # 6055.01 (October 2014) titled Safety and Occupational Health Program applies to all DoD components; it does not apply to DoD contractor personnel and contractor operations. The contractor is directly responsible for complying with federal and State occupational safety and health standards for its employees. **All regulations and standards for Fall Protection and health and safety contain minimum requirements. However, DoD Instruction 6055.01 does not preclude DoD components from developing different standards that are more protective than OSHA.**

## **1.9 COMPARISON AMONG OSHA STANDARDS , DON AND USACE EM 385-1-1 FALL PROTECTION REQUIREMENTS**

Appendix A of this guide provides comparison among various OSHA Fall Protection standards (Construction and General Industry), OPNAVINST 5100.23 Series, MCO 5100.29 Series, NAVMC DIR 5100.8 and the USACE EM 385-1-1 Series, Fall Protection Requirements. When all the Fall Protection standards and regulations (specifically OPNAVINST 5100.23 Series FP program chapter 13, and the USACE EM 385-1-1 Section 21 requirements) are compared, they are similar in the application and use of Fall Protection systems and equipment. The only difference is the threshold limit where Fall Protection is required (4, or 6 ft. height) and few minor applications. These threshold heights only affect the level at which temporary guardrails and work platforms are installed or used. According to the Building Codes, if there is a break of 30 inches (2½ feet) or more between levels, the edges must be guarded by permanent guardrails. Fall-arrest equipment cannot be used at these low elevations (i.e., 4 or 6 feet). The minimum clearance required for safely using fall-arrest systems is approximately 11 feet (depending on the length and type of the energy absorbing lanyard used, [e.g., Self-retracting Devices], the height of anchorage point, and available clearance. Other fall-arrest systems will require more clearance. Work platforms, with minor modifications, can be adjusted to the required threshold height. A positioning system will require a minimum of 8 feet or more below the tie-off point. Additionally, restraint, travel restraint, warning line systems or designated area that may be used at any elevation and will not be affected by the prescribed threshold limits of 4 or 6 feet, because when using those systems personnel will not be exposed to a Fall-Hazard. The only effect the threshold height limitations will have on safe walking working surfaces is the installation of temporary guardrails, existing loading docks, and parts of ramps above 4 feet.

## **1.10 INSTRUCTIONS, REGULATIONS and STANDARDS**

**1.10.1** OPNAVINST. 5100.23 Series, Navy Safety and Occupational Health Program Manual; Chapter 13, Fall Protection Program;

**1.10.2** MCO 5100.29B Marine Corps Safety Program

July 2017

**1.10.3** NAVMC DIR 5100.8 Marine Corps Occupational Safety and Health (OSH) Program Manual: Chapter 18 Fall Protection Program

**1.10.4** US Army Corps of Engineers (USACE), Safety and Health Requirements Manual, EM 385-1-1, current edition; shall be included and enforced on all DOD contracts involving construction, dismantling, demolition or removal work. Contractors performing such work shall comply with all pertinent provisions of the latest version of the manual (FAR 52.236-13 Accident Prevention);

**1.10.5** 29 CFR, PART 1926.500, Subpart M, Fall Protection Requirements in the Construction Industry;

**1.10.6** 29 CFR, PART 1910 (1970), Occupational Safety and Health Standards for General Industry;

**1.10.6.1** 29 CFR 1910 (17 November 2016) Final Rule– Walking and Working Surfaces and Personal Protective Equipment (FP Systems);

**1.10.7** 29 CFR PART 1915, Occupational Safety and Health Standards for Shipyard Employment;

**1.10.8** 29 CFR 1917, Marine Terminals;

**1.10.9** 29 CFR PART 1918, Safety and Health Regulations for Long-shoring;

**1.10.10** 29 CFR PART 1960, Basic Program Elements for Federal Employee Occupational Safety and Health Programs;

**1.10.11** Department of Defense Directive 6055.1, Occupational Safety and Health Program;

**1.10.12** American National Standards Institute (ANSI):

**1.10.12.1** ANSI/ASSE Z359 Series Fall Protection Code/Standards,  
(See Chapter 18 for description of these standards);

**1.10.12.2** ANSI/ASSE A1264.1 (R2007): Safety Requirements for Workplace Walking/Working Surfaces and Their Access, Workplace Floor and Wall Openings, Stairs and Railing Systems;

**1.10.12.3** ANSI/ASSE A14.3 (R2008) Safety Requirements for Fixed Ladders;

**1.10.12.4** ANSI/ASSE A10.32 (2012) Personal Fall Protection Used in Construction and Demolition Operations

**End of Section**



## 2.0 DEFINITIONS

**Activation Distance:** The distance traveled by fall-arrester or the amount of line paid out by self-retracting lanyard from the onset of a fall to the point where the fall arrester or self-retracting lifeline begins to apply a braking or stopping force.

**Active Fall Protection system:** A Fall Protection system that requires end-users to wear or use Fall Protection equipment and that requires fall protection training. Active fall protection systems can include any travel restraint or fall arrest systems.

**Adjuster:** A component that provides a means to enlarge or shorten the length of strap, webbing or rope.

**Administrative Controls:** Policies and procedures for safe work practices. This may include training, warning lines/signs or other methods to warn a person approaching a fall hazard.

**Anchorage:** A secure connecting point or terminating component of personal fall protection system that can safely withstand the forces exerted by the activation of Fall Protection and rescue equipment. The anchorage is a secured structure, can be in the form of a beam, girder, column, or floor. Anchorage is either engineered or improvised.

**Anchorage Connector:** A component or subsystem by which Fall Protection or rescue equipment is secured or attached to the anchorage. This can include a steel cable sling, tie-off adapter (anchor strap), load-rated hoist ring designed for construction applications, tripod, davit arm, or any other device designed to suspend human loads and capable of withstanding forces generated by a fall.

**Anchorage System:** A combination of anchorage and anchorage connector.

**Arresting Distance:** The total vertical distance required to arrest a fall. Includes activation and deceleration distance. Arresting distance does not include free-fall distance.

**Arresting Force:** The force exerted on a worker, when a Fall Protection System stops the fall. The magnitude usually expresses the peak force experienced during a fall.

**Assigned Safety Person (Spotter):** An employee assigned to check periodically (at least every 5 minutes) visually or verbally to assure that an end-user has not fallen and is suspended in his/her harness. This assigned safety person shall have the ability to make quick contact with the jurisdictional public/Government-emergency response agency. This is also known as the "Buddy System".

**Assisted Rescue:** A planned means of rescue, requiring the assistance of others.

**Attachment Element Extender:** Often also called a D-ring extender; a small lanyard temporarily or permanently attached to a harness intended to extend the attachment element

away from the user's body to facilitate ease of attachment.

**Authorized Person:** See the definition of End-user.

**Authorized Rescuer:** A person who is trained on rescue procedures and assigned by the Command/Activity to rescue end-user who may require rescue.

**Automatic Descent Control Device:** A load lowering device or mechanism that once engaged will automatically control pay-out speed of line or descent speed under load. Some automatic controlled descent devices have self-retracting lanyard capability.

**Available Clearance:** The distance from the walking working surface or platform to the nearest obstruction that the end-user might contact during a fall.

**Back-Strap:** A strap located on the back of a FBH that connects between the straps below the dorsal location and above the waist, which is intended to keep the body from exiting the rear of the harness.

**Ballasted Anchor:** An anchorage connector that rests on, but not mechanically connected to an underlying structure.

**Body Belt:** A body support comprised of a strap with means for securing it about the waist. **(Use in a personal fall-arrest system is prohibited).**

**Body Harness:** Means of configuration of connected straps secured about the employee in a manner that will distribute the arresting forces over at least the upper thighs, waist, shoulders, chest and pelvis, with means for attaching a lanyard to other components of the personnel fall-arrest system. Full-body harness is the only body support device allowed by OSHA or ANSI when a free-fall distance exceeds two feet.

**Boatswain's (Boson's) Chair:** A single-point adjustable suspension scaffold consisting of a seat or strap designed to support one employee in a sitting position. The seat is made of a plywood or strap independently suspended from an anchorage, and the employee, using full-body harness attached to a separate lanyard or lifeline attached to an independent anchorage, may sit to help alleviate the pooling of blood in the legs.

**Brake Bar Rack:** A series of smooth bars connected together in parallel in which a synthetic rope is intertwined so that the friction of the rope against the bars controls the descent of a lowering device (often used in a rope rescue system).

**Buckle:** A connector used for attaching the strap or webbing segments together or to themselves.



**Capacity:** The maximum weight that a component, system, or subsystem is designed to hold. This includes combined weight of the user, clothing, tools and other objects carried by the end user.

**Cable Guide:** A device that acts to guide or connect flexible carriers to the climbing ladder or structure at intermediate points along the carrier. Cable guides may be automatically bypassable or may require the climber to remove the carrier cable from the guide before passing.

**Cable Grab:** See fall-arrester.

**Cage:** An enclosure mounted on the side rail of a fixed ladder or fastened to a structure behind the fixed ladder that is designed to surround the climbing space of the ladder.

**Carabiner:** A connector component generally consisting of an oval- or trapezoidal-shaped body with a closed gate or similar arrangement that may be opened to attach another object and when released automatically closes to retain the object. **Only self-locking carabiners are acceptable for use.**

**Carrier:** The specified track of a climbing ladder fall arrest system consisting of a flexible or rigid member upon which the carrier sleeve travels. The carrier is secured to the climbing ladder or structure by carrier mounting brackets. The carrier may be continuous or may contain joints or splices.

**Carrier Gate:** A specific portion of the carrier designed to allow removal and installation of the carrier sleeve on or off of the carrier. Carrier gates may be located at any point along the Climbing Ladder Fall Arrest System carrier but are most commonly located at the top and bottom of the system or at an intermediate entry/egress point.

**Carrier Mounting Brackets:** Elements of a climbing ladder fall arrest system that connects the carrier to the climbing ladder or structure. Top and bottom brackets for flexible carriers and intermediate brackets for rigid carriers are examples of carrier mounting brackets.

**Carrier Sleeve:** The device of a climbing ladder fall arrest system that is connected to the user and travels along the carrier in response to climbing movements but automatically stops on the carrier in the event of a fall. Carrier sleeves are sometimes referred to as “cable grabs” for flexible carriers.

**Carrier Stop:** A device fitted to the carrier to prevent the carrier sleeve from unintentionally passing a specific point or becoming detached from the carrier. Carrier stops may or may not be subject to fall arrest loading depending on location. Some system carrier mounting brackets may function as a carrier stop.

**Certification:** The act of attesting in writing that the established criteria have been met.

July 2017

**Certified:** An act or process resulting in documentation that determines and attests to criteria that meet the requirement of ANSI Z359 Standards. Such act or process may be carried out by testing or applying proven analytical methods, or both, under the supervision of a qualified person for fall protection or other entity (i.e. Professional Engineer).

**Certified Anchorage:** An anchorage for fall arrest, positioning, restraint or rescue system that a Qualified Person for Fall Protection certifies to be capable of supporting the potential fall forces that could be encountered during a fall.

**Clearance:** The distance from a specified reference point, such as the working platform or anchorage of a fall-arrest system, to the lower level that a worker might encounter during a fall.

**Clearance Requirement:** The distance below the end use that must remain clear of obstructions in order to ensure that the end user does not encounter any object or obstruction during a fall.

**Climbing Extension:** A specialized carrier mounting bracket of the climbing ladder fall arrest system that extends the system carrier above the top step or rung of the climbing ladder for purposes of transitioning on or off the climbing ladder.

**Climbing Ladder.** A climbing surface that includes rungs, step bolts, or similar foot and hand holds that can be climbed while maintaining three points of contact which is part of or affixed to a structure.

**Climbing Ladder Fall Arrest System:** An assembly of components whose function is to arrest the fall of a user. The system includes the carrier, carrier mounting brackets and the carrier sleeve. The carrier is securely attached to the climbing ladder or to the immediately adjacent structure.

**Competent Person (CP) for Fall Protection:** A person designated by the Command to be responsible for the immediate supervision, implementation and monitoring of the Fall Protection program, who through training knowledge and expertise is capable of identifying, evaluating and addressing existing and potential Fall-Hazards and in the application and use of personal fall protection and rescue system, or any component thereof, AND who has the authority to take prompt corrective measures to eliminate or control the hazards of falling.

**Competent Person Trainer:** A person who by training, knowledge and experience is capable of conducting a competent person training.

**Competent Rescuer:** An individual designated by the employer who by training, knowledge and experience is capable of the implementation, supervision and monitoring of the Command/Activity fall protection rescue program.

**Competent Rescue Trainer:** A person who by training, knowledge and experience specific to fall protection rescue is capable of conducting rescue training.

**Connecting Means:** The method to connect body support to an anchorage, such as a lanyard, snaphook or a carabiner for the purpose of providing protected mobility for an elevated work task.

**Connecting Subsystem:** An assembly, including the necessary connectors, comprised of components, subsystems or both, between the anchorage connector and the D-ring of body harness.

**Connection Linkage:** A connector or a combination of elements, which is integral to the carrier sleeve, and which forms the link between the carrier sleeve and the attachment element of the full body harness.

**Connector:** A device used to couple (connect) parts of the personal fall protection system together. It may be an independent component of the system, such as a carabiner, or it may be an integral component of part of the system (such as a buckle or D-ring sewn into a body belt or body harness, or a snap-hook spliced or sewn to a lanyard or self-retracting lanyard).

**Continuous Fall Protection:** One or more fall protection systems that provide fall protection without interruption.

**Controlled Access Zone (CAZ):** A zone to restrict access to unprotected edge work. The CAZ is bounded by a control line and should run the full length of the unprotected edge and connect on each side to a guard or wall. The control line can be made of rope, wire, tape, or equivalent material and shall be supported by stanchions and marked with a highly visible material. **(The use of controlled access zone is prohibited as a fall protection system).**

**Dangerous Equipment:** Means equipment, such as vats, tanks, electrical equipment, machinery, equipment or machinery with protruding parts, or other similar units, because of their function or form, may harm an employee who falls into or onto the equipment

**Deceleration Device:** Any mechanism, such as a fall-arrester (rope grab), rip-stitch lanyard, specially-woven lanyard, tearing or deforming lanyards, automatic self-retracting devices, etc., which serves to dissipate a substantial amount of energy during a fall-arrest, or otherwise limit the energy imposed on an employee during fall-arrest.

**Deceleration Distance:** The vertical distance, measured between the location of the user's fall-arrest attachment point (dorsal D ring) at the onset of fall-arrest forces during a fall (and after the fall-arrest attachment point comes to a complete stop), is the additional vertical distance a falling employee travels (excluding dynamic elongation and free-fall distance) before stopping, from the point at which the deceleration device begins to operate or deploy.

**Descent Controller:** A device designed to be used by one worker for personal descent to lower another person from an elevation. Descent control may be used for egress, positioning or both.

July 2017

**Designated Area:** A distinct portion of a walking-working surface, delineated by a perimeter warning line, in which employees may perform work without additional Fall Protection. **The designated area is used only for general industry work.**

**D-ring:** An integral “D” shaped connector typically used in harnesses, lanyards, energy absorbers, lifelines, and anchorage connectors as an attachment point.

**Dorsal:** A location on a full body harness that falls approximately between the user’s shoulder blades

**End-user of Fall Protection (Authorized Person):** A person who has been trained in the use of assigned Fall Protection equipment, including hands-on training and practical demonstrations in a typical Fall-Hazard situation, and uses personal fall-arrest or restraint/positioning equipment while performing work assignments at heights.

**Energy (Shock) Absorber:** A component whose primary function is to dissipate energy and limit deceleration forces that the system imposes on the body and the anchorage system during fall-arrest.

**Energy Absorber, Horizontal Lifeline.** An energy absorber that is attached to one of the end anchorages or anchorage connectors of a horizontal lifeline subsystem.

**Energy Absorber, Personal.** An energy absorber that is attached to a harness.

**Energy Absorber, Single Anchor Vertical Lifeline.** An energy absorber that is attached to the top anchorage or anchorage connector of a single anchor vertical lifeline subsystem.

**Engineered Anchor:** An anchorage designed and approved by a Qualified Person.

**Equipment:** A general term referring to components, subsystems or systems, in any combination, singular or plural.

**Evacuation harness:** A component for rescue purposes consisting of elements designed and constructed so that the rescue subject is securely held during the rescue process. Evacuation harness is a special harness.

**Failure:** Load refusal, breakage, or separation of component parts. Load refusal is the point at which the ultimate strength is exceeded.

**Fall Arrest:** The action or event of stopping a free fall or the instant the downward free-fall has been stopped.

**Fall-arrest System:** A combination of equipment and components such as full-body harnesses, lanyards, deceleration devices, anchorages, horizontal or vertical lifelines

July 2017

connected together, designed to stop a person from striking a lower level or an obstruction during a fall.

**Fall arrester:** A device that travels on a lifeline and will automatically engage or lock onto the lifeline in the event of a fall. A rope grab is one example of fall arrester. .

**Fall Hazard:** Any location where a person is exposed to a potential free fall. This could be unprotected side or edge of a walking/working surface or unprotected opening from which a person will fall to lower surface.

**Fall Hazard Survey Report:** A written document that contains information about existing or potential fall hazards and a method or methods for eliminating, preventing or controlling those hazards.

**Fall Prevention:** The elimination and minimization of potential Fall-Hazards, lessening the chance of employee exposure to falls. Any same-level means used reasonably to prevent exposure to a Fall-Hazard; examples of fall prevention are guardrails, walls, floors, and area isolation. Also called passive fall protection system.

**Fall Protection:** .Action and procedures to protect a worker effectively from Fall-Hazards. Any equipment, device or system that prevents an accidental fall from elevation or that mitigates the effect of such a fall.

**Fall Protection System:** A system that prevents workers from falling or, if a fall occurs, arrests the fall. Examples include guardrails, restraint, safety net and fall arrest systems.

**Fall Restraint:** See “Restraint System”.

**Fall Protection Program Manager:** A person assigned by the command to be responsible for developing and managing the Fall Protection program at a Navy Command.

**Flexible Carrier:** A carrier constructed of stranded wire rope or other flexible line materials. Flexible carriers are typically mounted to the climbing ladder or structure only at the top and bottom of the system and are generally installed under some amount of tension.

**Force Factor:** The ratio of peak arresting force of a rigid mass to a human body having the same weight, both falling under identical conditions.

**Forced Roll-out:** An action by which the gate of a **locking** snap-hook or carabiner is loaded beyond its design strength, forcing it to fail and disengage from the component to which it was attached.

**Free-fall:** The act of falling before a personal fall-arrest system begins to apply force to arrest a fall.

July 2017

**Free-Fall Distance:** The vertical distance from the onset of a fall to a point where a fall-arrest system is activated or engaged. (This is the vertical distance measured from the fall-arrest attachment point on the employee's body harness at the onset of the fall to the point just before the system begins to apply force to arrest the fall. This distance excludes deceleration distance, and lifeline/lanyard elongation which are exerting deceleration forces, but includes any deceleration device slide distance or self-retracting lifeline/lanyard extension before they operate and fall-arrest forces occur.)

**Frontal:** A location on the front of a full body harness that falls below the end user's chest area.

**Frontal D-Ring Attachment:** An attachment element affixed to the full body harness within the vertical seven-inch sternum (breastbone) area that is designed to withstand dynamic fall arrest, restraint, and post-fall suspension forces.

**Full-body harness:** See the definition of "Body Harness".

**Full Body Harness Stretch:** The difference between the lowest point on the torso post-fall and the lowest point on the torso pre-fall in relation to the attachment element. This accounts for a component of the system stretch out and total fall distance.

**Guardrail System:** A passive fall protection system of horizontal rails and vertical posts that prevent a person from reaching a fall edge. Guardrail systems typically have a top rail, a mid rail and posts and toeboard.

**Hardware:** A rigid component or element that is used to couple parts of the system together.

**Hazard Elimination:** Changing the task, process, controls or other means so as to remove the need for the end user to be exposed to a fall hazard.

**Hole:** Means a gap or open space in a floor, roof, horizontal walking-working surface, or similar surface that is at least 2 inches in its least dimension.

**Horizontal Lifeline:** A component of a horizontal lifeline subsystem, consisting of a flexible line with connectors or other coupling means at both ends for securing it horizontally between two anchorages or anchorage connectors.

**Horizontal Lifeline Subsystem:** An assembly, including the necessary connectors, comprised of a horizontal lifeline component and, optionally, of: a) An energy absorber component or, b), a lifeline tensioner component, or both. This subsystem is normally attached at each end to an anchorage or anchorage connector and may also contain one or more intermediate anchorages. The end anchorages have the same elevation.

**Horizontal Track System:** A form of rigid rail system that typically encloses a trolley inside a

formed channel or track.

**Hybrid Component:** An integral assembly of elements or components, or both, intended to perform more than one function in the system.

**"Infrequent:** Means that the task or job is performed only on occasion, when needed (e.g., equipment breakdown), on an occasional basis, or at sporadic or irregular intervals. Infrequent tasks include work activities such as annual maintenance or servicing of equipment, monthly or quarterly replacement of batteries or HVAC filters, and responding to equipment outage or breakdown. In these instances, the frequency of exposure to fall hazards is very limited. By contrast, tasks performed or repeated on a daily, routine or regular basis are not infrequent activities within the meaning of the final rule. Infrequent jobs also do not include those that workers perform as a primary or routine part of their job or repeatedly at various locations during a work-shift. A task may be considered infrequent when it is performed once a month, once a year, or when needed.

**Ladder Climbing (Safety) Device:** See Climbing ladder fall arrest system.

**Hybrid Component:** An integral assembly of elements or components or both, intended to perform more than one function in the system.

**Initial Sag:** The initial mid-span deflection on a horizontal lifeline due to static equilibrium between gravitational forces and pre-tension.

**Integral:** Not removable from the component, subsystem or system without destroying or mutilating any element or without use of a special tool.

**Lanyard:** A component consisting of a flexible line of rope, wire rope, or strap that usually has a connector at each end for connecting the body support and to a fall arrester, energy absorber, anchorage connector, or anchorage.

**Lanyard Parking Attachment Element:** A loop device to facilitate the temporary storage of an unused leg of the lanyard.

**Leading Edge:** The unprotected side and edge that exposes a worker to a Fall-Hazard. It can be the edge of a floor, roof, or formwork for a floor or other walking/working surface where the edge changes location as additional floor, roof, decking or formwork sections that are placed, formed, or constructed.

**Lifeline:** A component consisting of a flexible line which is connected either to an anchorage at one end, and hangs either vertically (single anchor vertical Lifeline), or is connected to anchorage at both ends and stretches horizontally (Horizontal Lifeline); both of which serve as means for connecting other components of a personal fall-arrest system.



July 2017

**Lifeline Tensioner:** A device, such as a turnbuckle, to tauten a horizontal lifeline or a weight to tension a vertical lifeline.

**Load-bearing Straps:** Straps as part of the full body harness through which load is transmitted during a fall or under normal use.

**Man Overboard Plan:** A man overboard plan is an emergency plan for rescuing personnel if they accidentally fall into the water.

**Manual Descent Controlled Device:** A load-lowering device or mechanism that, once engaged, requires manual attention to control pay-out speed of line, or descent speed under load.

**Manual Fall Arrester (Manual Rope Grab):** A fall arrester that will remain locked where it has been positioned on a VLL until deliberately repositioned by a worker.

**Marking:** Any sign, label, stencil, plate or the like containing information or guidance.

**Maximum Arrest Force (MAF):** The peak force exerted on the body when a Fall Protection system arrests or stops a fall.

**Maximum Arrest Load (MAL):** The peak force applied to an anchorage by an active fall protection system when arresting a fall.

**Non-Certified Fall Protection Anchorages:** An unquestionably strong anchorage that a Competent Person judges to be capable of supporting the predetermined anchorage strength as prescribed by OSHA Standards and ANSI/ASSE Z359 Fall Protection Code. Non-Certified anchorages are used for fall-arrest, work positioning, travel restraint, or rescue.

**Opening:** Means a gap or open space in a wall, partition, vertical walking-working surface, or similar surface that is at least 30 inches high and at least 18 inches wide, through which an employee can fall to lower level.

**Orthostatic Intolerance (suspension Trauma):** The development of symptoms as a result of suspension in a full-body harness, such as light-headedness, palpitations, tremulousness, poor concentration, fatigue, nausea, dizziness, headache, sweating, weakness, and occasionally fainting and unconsciousness.

**Passive Fall Protection System:** A system that does not require a worker to use or wear personal fall-arrest equipment. Examples include safety nets, guardrails, parapet walls, etc.

**Personnel:** All military and DON civilians.

**Personal Energy Absorber:** See “Energy Absorber”.



July 2017

**Personal fall-arrest System:** Assembly of components and subsystems used to arrest an end-user falling from height. It consists of an anchorage system, connecting means, and full body harness, and may include a lanyard, deceleration device, lifeline, or suitable combination of these. **Use of a body belt in a personal fall-arrest system is prohibited.**

**Platform:** A walking working surface that is elevated above the surrounding area.

**Positioning Lanyard:** A lanyard used to transfer forces from a body support to an anchorage or anchorage connector in a positioning system.

**Positioning Line:** A vertical, horizontal or angled rope or wire rope used to transfer forces from a body support to an anchorage or anchorage connector in a positioning system.

**Positioning System:** A combination of equipment including a full-body harness rigged to allow the end-user to work with both hands free while being supported on an elevated vertical or inclined work surfaces. Positioning lanyard may be fixed length or adjustable and is part of positioning system.

**Pre-Incident Plan:** A formal written plan, prepared jointly by the host DON activity and the fire emergency responders, containing factors that need to be evaluated when assessing the potential situations that could affect a facility during emergency conditions.

**Primary System:** In fall protection terminology, the main mechanism that allows a worker to maintain his or her desired position.

**Qualified Person (QP) for Fall Protection:** A person with a recognized **engineering** degree or professional certificate and with extensive knowledge, training, and experience in the Fall Protection and rescue field, who is **capable of designing, analyzing, evaluating, and specifying fall protection and rescue systems and equipment.**

**Qualified Person Trainer:** A person who is qualified to provide fall protection training to the qualified person.

**Rescue:** The process of evacuating a person or persons from danger, harm or confinement to a safe location where they also may receive medical attention.

**Rescue Ladder:** A flexible ladder with rigid rungs and either synthetic webbing or wire rope side rails which can be temporarily hung next to the end-user working at heights, or can be lowered to an end-user suspended in a harness, to allow him to climb back up to the working surface (or at least stand on the ladder while awaiting rescue, allowing the necessary circulation of the blood to the entire body while an assisted rescue is being commenced).

**Rescue Lanyard:** A component consisting of flexible line of rope or strap, which usually has a connector at each end for connecting the body support to components of a rescue system. A rescue lanyard is a special lanyard.

**Rescue Plan (Fall-arrest):** A written plan that describes the rescue method and procedures to be used to rescue an end-user of Fall Protection, who may have fallen from a height and be suspended in a full-body harness. The suspended worker may have been injured or incapacitated prior to, or as the result of, the fall (See section 10.13 for a sample fall-arrest rescue plan).

**Restraint System:** A combination of devices designed to restrain an end-user from reaching an exposed Fall-Hazard. The system consists of a full-body harness that can be secured around a worker and attached to a load-bearing anchorage in order to restrict travel and limit Fall-Hazards. The strap can be single or multiple.

**Rigid Anchorage Subsystem:** An anchorage system, such as a rigid rail or trolley system or a single point of attachment, which does not appreciably deflect, deform, or stretch when a fall-arrest impact occurs.

**Rigid Carrier:** A carrier constructed of a single piece or multiple joined pieces of solid material that forms a rigid member. Carrier stops may or may not be subject to fall arrest loading depending on location. Some system carrier mounting brackets may function as a carrier stop.

**Rigid Rail System:** A fall protection system that uses one or more trolleys on a horizontal track (often an I-beam or slotted tube).

**Rigging:** The process of building a system to move or stabilize a load or the system itself.

**Roll-out:** A process by which a snap-hook or carabiner unintentionally disengages from another connector or object to which it is attached.

**Rope Access:** A technique consisting of two lifelines independently anchored at the top to protect the authorized person from falling. The ropes directly suspend the person. The technique is used on buildings, bridges, and other structures for conducting inspection, cleaning, and painting.

**Rope (or Strap) Adjuster:** A mechanical means of readily moving a vertical line attachment or changing the position of an intermediate anchorage device between an anchorage (connector) and a body support while loaded with the authorized person's weight or partial weight while leaning.

**Rope Grab: See Fall-arrester.**

**Rope, Synthetic:** A construction of bundled manmade yarns, fibers, or filaments forming a strong flexible line.

**Rope, Wire:** A plurality of drawn wires forming strands laid helically over an axis or core.

July 2017

**Runway:** 1. a passageway for a person, elevated above the surrounding floor or ground level, such as a foot-walk along shafting or a walkway between buildings.

2. Elevated crane rails upon which an overhead electric crane travels.

**Sag:** The distance the wire rope or synthetic cable of a horizontal lifeline deviates from the horizontal plane established by the end anchorage. This is defined by the line between two anchorages, measured downward at the mid-point of the wire rope or cable.

**Safety Margin:** A clearance factor of safety defined as the distance between the lowest extremity of the worker's body at fall arrest and the highest obstruction the worker might otherwise make contact with during a fall.

**Safety Net System:** A horizontal or semi horizontal cantilever-style barrier that uses netting system to stop falling workers before they make contact with a lower level or obstruction.

**Safety Strap/Relief Step Strap:** A coiled strap (in a pouch) attached to the lanyard which is manually deployed after a fall, and allows the end-user to insert one foot (or two feet, depending on the style) into the loop step and stand allowing the necessary circulation of blood to the entire body, while an assisted rescue is being commenced.

**Secondary Fall Protection System.** One or more means of fall protection, as defined by these standards, configured as a supplement or as backup to protect a worker from a potential fall if the primary system fails.

**Self-Retracting Device (SRD):** A device that contains a drum wound line that automatically locks at the onset of a fall to arrest the user, but that pays out from and automatically retracts onto the drum during normal movement of the person to whom the line is attached. After onset of a fall, the device automatically locks the drum and arrests the fall. Self-retracting devices include self-retracting lanyards (SRL's), self-retracting lanyards with integral rescue capability (SRL-R's), and self-retracting lanyards with leading edge capability (SRL-LE's) and, hybrid combinations of these.

**Self-Retracting Lanyard (SRL):** A device suitable for applications where during use, the device is mounted or anchored such that possible free fall is limited to 2 ft. or less.

**Self-Retracting Lanyard with Integral Rescue Capability:** A SRL that includes integral means for assisted-rescue via raising or lowering the rescue subject.

**Self-Retracting Lanyard with Leading Edge Capability (SRL-LE):** A self-retracting device, used for horizontal applications, which is mounted or anchored at "foot" level and where there is the possibility of free-fall. The device includes integral means to withstand impact loading of the line contiguous with a sharp or abrasive edge during fall-arrest and for controlling fall-arrest forces on the user. The device can also be used for vertical applications where it is mounted overhead.

**Seat Sling:** A seat sling designed for attachment to a full-body harness, designed so that a worker may sit for a short period of time without pooling of blood in the legs.

**Self/Manual Deploying Rescue Ladder:** A coiled webbing rescue ladder (in a pouch) connected to the lanyard or anchorage which either self-deploys during a fall, or is manually released by the end-user after a fall, and is left dangling next to the suspended end-user. This allows the end-user to climb back up to the anchorage (or at least simply stand in the ladder, allowing the necessary circulation of blood to the entire body while an assisted rescue is being commenced).

**Shall:** The word shall is to be understood as denoting a mandatory requirement.

**Shock Absorber: See Energy Absorber**

**Should:** The word should denote a recommendation.

**Single Anchor Vertical lifeline (VLL):** A flexible line along which a fall arrestor travels that is supported by a single anchorage. Single anchor vertical lifeline can be used in vertical, horizontal or sloped applications.

**Snaphook:** A connector comprised of a hook-shaped body with a normally closed gate or similar arrangement, which may be opened to permit the hook to receive an object, and when released, automatically close to retain the object. **Only self-locking (single- or double-locking) snaphooks are acceptable for use.**

**Soft Loop Attachment Element:** A non-metallic attachment element of a FBH constructed of synthetic fiber webbing.

**Stable Surface:** A walking working surface that has the strength and structural integrity to support the end user(s).

**Strap:** A length of webbing that may be incorporated in a harness, lanyard or other component or subsystem.

**Sternal:** A location on a FBH that falls approximately between the user's chest area.

**Suspension:** The act of supporting 100% of a user's body weight, including equipment, for the purpose of accessing a work location with one or two points of contact.

**Strap, Chest:** A harness strap passing generally horizontally across the chest or around the body at chest level with adjustable means for fastening.

**Strap, Shoulder:** A harness strap that passes from the waist, up the chest, over the shoulder and down the back to the waist. It is connected to the waist strap or thigh straps or sub-pelvic strap or combinations thereof.

July 2017

**Strap, Sub-Pelvic:** A full body harness strap, which passes under the buttocks without passing through the crotch and is designed to transmit, to the sub-pelvic part of the body, forces applied during fall arrest and post-fall suspension.

**Stretch Out:** The change in distance between the end users D-ring and toes during a fall arrest.

**Suspension:** The act of supporting 100% of the end user's body weight, including equipment for the purpose of accessing a work location with one or two points of contact. .

**Suspension Seat:** An arrangement of straps in a harness used to provide a body support and permit leaning or sitting while working.

**Suspension Trauma (Harness-induced Pathology):** Where the body is at rest in a vertical state with the lower body motionless, and blood begins to pool in the lower extremities because the muscles in the legs are not contracting on the veins and helping the blood back to the heart (against gravity). Blood is not properly circulated, the individual's blood pressure drops, the brain does not receive adequate blood flow and unconsciousness follows.

**Suspension Trauma Safety Steps/Relief Step Strap:** A coiled strap (in a pouch) attached to the harness which is manually deployed after a fall to help prevent the effects of suspension trauma by allowing the end-user to insert one foot (or two feet, depending on the style) into the loop step and stand up allowing the necessary circulation of blood to the entire body, while an assisted rescue is being commenced.

**Swing fall:** A pendulum-like motion that can result from moving horizontally away from, or toward, a fixed anchorage, and falling. Swing falls generate the same amount of force when falling the same distance vertically. Swing fall has the hazards in both the horizontal direction (swinging into obstruction) and vertical direction (falling onto obstructions or ground).

**Swing Fall Distance:** The vertical drop in height experienced by the worker using a fall arrest system from the onset of the swinging motion to the lowest point reached during a swing.

**Synthetic Rope Tackle Block:** A load lifting and/or lowering device that does not include a winding or traction drum but uses pulleys to achieve a mechanical lifting advantage (often used in a rope rescue system).

**Temporary:** Means that the duration of the task the worker performs is brief or short. Temporary and brief or short tasks generally include those that a worker is able to perform in less time than it takes to install or set up conventional fall protection. Temporary tasks generally are limited to "simple" tasks and "short-term, scheduled maintenance or minor repair activities" temporary and simple tasks are those that do not require "significant equipment, personnel, and other resources" or a level of exposure that "long-term" or "complicated" maintenance and repair work does. Short duration tasks generally are those that take less than "1 - 2 hours" to complete.

**Testing, Qualification:** The controlled application of test conditions to a product specimen randomly selected from the initial production lot, and the recording of observed effects, for the purpose of determining the product's compliance with the requirements of these standards. When the terms "testing" or "tests" are used in the Z359 standards, those terms shall denote qualification testing or qualification test(s), not developmental or verification testing or test(s) unless otherwise specified.

**Testing, Verification:** The controlled application of test conditions to a product specimen sampled from ongoing production lots (after qualification testing), and the recording of observed effects, for the purpose of confirming the product's continuing compliance with the requirements of these standards. Proof load testing is a type of verification testing.

**Thimble:** A grooved metal or plastic piece about which a rope is bent and spliced or swaged to the main body of the rope to form an eye.

**Toeboard:** A low protective barrier to prevent the fall of materials and equipment to lower levels and provide protection from falls for personnel.

**Total Fall Distance:** The total vertical distance fallen by the worker using a fall-arrest system between the onset of a fall and the instant when the worker first achieves zero vertical velocity; or the vertical distance fallen by an end-user connected by a fall-arrest system to an anchorage measured from the walking/working surface and extending downward to a position after the fall is arrested. The total fall distance includes the sum of the free-fall, elongation, and deceleration distances of the system.

**Travel Restraint:** See restraint system.

**Travel Restraint Lanyard:** A lanyard used to transfer forces from a body support to an anchorage or anchorage connector in a travel restraint system. Travel restraint lanyard may be fixed length or adjustable and is part of the restraint system.

**Travel Restraint Line:** A rope or wire rope used to transfer forces from the body support to an anchorage or anchorage connector in a travel restraint system.

**Trolley:** A mobile anchorage device that travels along a track (horizontal track system), structural beam (rigid rail system), or cable (HLL system).

**Waist:** A location on a FBH corresponding to the area on the body falls typically between the thorax and hips.

**Warning Line System:** A barrier erected on roof to warn workers that they are approaching an unprotected side or roof edge, and which designates an area where roof work may take place without the use of guard, fall-arrest, or safety net systems to protect workers in the area. Work performed outside barriers will require Fall Protection. A warning line system is used during construction work.

July 2017

**Walking/Working Surface:** Any surface, whether horizontal or vertical, on which an employee walks or works, including, but not limited to, floors, roofs, ramps, bridges, runways, form work, and concrete reinforcing steel (but not including ladders, vehicles, or trailers), on which employees must be located in order to perform their job duties.

**Webbing:** A narrow woven fabric with selvedge edges and continuous filament yarns made from light and heat resistant fibers.

**Winch/hoist:** A load lifting and/or lowering device that incorporates a winding drum and means for controlling pay-out and take-up of the line from the drum.

**Wire:** A single, continuous length of metal with a circular cross-section that is cold-drawn from rod.

**Working Line:** A flexible line used for positioning and travel restraint.

**End of Section**



### **3. FALL PROTECTION PROGRAM**

According to OPNAVINST 5100.23 Series, MCO 5100.29 and NAVMC DIR 5100.8 FP Program Chapters, each Navy and Marine Corps Activity, which has personnel working at heights and exposed to Fall-Hazards, is required to establish and implement a managed Fall Protection program. The managed Fall Protection program shall be in writing, reviewed and approved by the DON activity's safety office.

As an alternative to this requirement, a Navy and Marine Corps activity, in lieu of developing a separate written program with safety office review and approval, may state in writing that it is using this *Guide* as its Fall Protection program.

**NOTE:**

DON Activities using the *Guide* as their program shall include site-specific Fall Protection requirements.

Navy or Marine Corps Commands/Units being supported by a Regional/Installation Safety Office can be included as part of the Region/Installation Fall Protection program. Coordinate with the Regional/Installation Safety Office to determine the level of support that will be provided.

#### **3.1 COMPONENTS OF A FALL PROTECTION PROGRAM**

- a. Activity Policy; (invoked by CO signed letter)
- b. Duties and Responsibilities;
- c. Workplace surveys and Assessment of Fall-Hazards;
- d. Fall-Hazard Prevention and Control, Including the preparation of **Site-Specific Fall Protection and Prevention Plans**;
- e. Training Requirements;
- f. Inspection, Storage, Care, and Maintenance of Personal Fall Protection Equipment;
- g. Rescue Plan and Procedures;
- h. Fall Mishap Reporting;
- i. Audits and Evaluation.

**Note**

All documentation of the fall protection program shall be maintained and updated periodically as long as the Command or Activity has personnel working at heights and exposed to fall hazards.

The following is a Sample Activity Fall Protection Program to assist various Navy and Marine Corps Commands in preparing and establishing site-specific Fall Protection programs and also a Compliance Audit Checklist is included for compliance w/OPNAVINST 5100.23 Series, Chapter 13 Fall Protection Program, MCO 5100.29 Series and NAVMC DIR 5100.8 Chapter 18.



July 2017

## **3.2 SAMPLE WRITTEN FALL PROTECTION PROGRAM**

**From: Commanding Officer [NAVY/MARINE CORPS Activity]**

**To: All [NAVY/MARINE CORPS Activity] Employees**

**Subj: [NAVY/MARINE CORPS Activity] FALL PROTECTION PROGRAM MEMORANDUM**

### **References:**

- (a) OPNAVINST 5100.23 Series (Navy), [or MCO 5100.29] [or Marine Corps NAVMC DIR 5100.8] Occupational Safety and Health Program Manual,
- (b) Department of the Navy Fall Protection Guide;
- (c) American National Standards Institute (ANSI) Z359 Fall Protection Code/Standards;
- (d) OPNAVINST 5102.1 D/MCO P5102, Navy and Marine Corps Mishap and Safety Investigation, Reporting and Record Keeping;
- (e) USACE EM 385-1-1 Safety and Health Requirements Manual;
- (f) 29 CFR 1926.500, Fall Protection in Construction;
- (g) 29 CFR 1910, Subpart D, Walking/Working Surfaces;
- (h) 29 CFR 1910 (17 November 2016) Final Rule for Walking Working Surfaces and Personal Fall Protection Systems;
- (i) Any other applicable instructions or manuals.

### **Enclosures:**

- (1) Fall-Hazard survey and assessment report (See section 5.3)
- (2) Fall Protection and prevention plan (See section 7.2)
- (3) Fall-arrest rescue plan (See section 10.13)

### **3.2.1 Purpose**

The purpose of this memorandum is to establish a Fall Protection program and provide policy and requirements for the implementation of the program and to establish procedures on Fall Protection and fall prevention for **[NAVY or MARINE CORPS Activity]** personnel working at heights and exposed to Fall-Hazards while conducting maintenance and inspection work.

### **3.2.2 Applicability**

This memorandum applies to **[NAVY or MARINE CORPS Activity]** personnel who are working at heights and exposed to Fall-Hazards while conducting construction, maintenance, or inspection work, and other personnel involved in the Fall Protection program.

### 3.2.3 Background

Falls from elevation are the leading cause of injuries and fatalities in the work place. Thousands of workers suffer injuries due to falls, resulting in lost time from work. References (a) and (b) direct all Navy and Marine Corps activities to establish a managed Fall Protection program. Additionally, reference (b) directs all Navy and MC Commands to establish Fall Protection programs which include identification, elimination, prevention or control of Fall-Hazards, wherever practical, through engineering controls, training of personnel, proper installation and use of Fall Protection systems, and required rescue equipment and procedures.

The nature of our work requires that **[NAVY or MARINE CORPS Activity]** personnel work at heights and to possibly be exposed to potential Fall-Hazards, or be exposed to falling onto dangerous equipment from any height. Not all **[cranes, buildings, roofs, structures or access to cranes or equipment]** have fully guarded working platforms, guardrails, walkways, or OSHA compliant ladders. Additionally, workers are frequently required to access areas that have unprotected walking working surfaces. Therefore; alternate Fall Protection methods, including fall-arrest gear, alternate access methods, and/or restrictions on access are required.

### 3.2.4 Command Fall Protection Policy

a. The **[NAVY or MARINE CORPS Activity]** is committed to provide a safe work environment for its personnel exposed to Fall-Hazards, and that the safety of all personnel including military and civilian personnel during performance of their work is of the utmost importance.

b. **[NAVY or MARINE CORPS Activity]** personnel shall take every reasonable precautionary measure to protect themselves and others during performance of their work.

**[c. As permitted in paragraph 1304, Chapter 13 of reference (a), the [NAVY or MARINE CORPS Activity] will use the Department of the Navy Fall Protection Guide, reference (b), as its Fall Protection program. The site specific program requirements are addressed in this memorandum.**

### 3.2.5 Requirements

a. **[NAVY or MARINE CORPS Activity]** personnel who might be exposed to Fall-Hazards and using Fall Protection equipment shall read and understand the requirements of this memorandum; Chapter 13 of reference (a); and the *Department of the Navy Fall Protection Guide*, reference (b).

b. **[NAVY or MARINE CORPS Activity]** personnel exposed to Fall-Hazards shall comply with the requirements of reference (b), including being protected from Fall-Hazards

when on any elevated walking working surface with unprotected sides, edges, or floor openings, from which there is a possibility of falling four feet or more to a lower level; or where there is a possibility of a fall from any height onto dangerous equipment, into a hazardous environment, or onto an impalement hazard.

- c. **[NAVY or MARINE CORPS Activity]** shall have an assigned Fall Protection Program Manager. Per paragraph 1306.a. of reference (a), a Fall Protection Program Manager is a person assigned by the command who is responsible for the development and implementation of the Fall Protection program. The **[NAVY or MARINE CORPS Activity's]** Fall Protection Program Manager shall ensure that all personnel exposed to Fall-Hazards, and using fall-arrest equipment and other personnel involved in the program, receive adequate training.
- d. Personal Fall Protection equipment used by **[NAVY or MARINE CORPS Activity]** personnel shall comply with the requirements in paragraph 1309 and appendix 13-B of reference (a), the requirements in reference (b), and ANSI Z359 Fall Protection Code/Standards requirements, reference (c).
- e. **[NAVY or MARINE CORPS Activity]** personnel exposed to Fall-Hazards shall be trained in fall prevention and Fall Protection in accordance to the requirements in paragraph 1310 and appendix 13-A of reference (a), and the training requirements in reference (b). Other personnel involved in Fall Protection program also shall receive Fall Protection training in accordance to the requirements in appendix 13-A of reference (a) and the requirements in references (b) and (c).
- f. Anchorages identified and used by **[NAVY or MARINE CORPS Activity]** personnel for fall-arrest equipment shall comply with the requirements in paragraph 1311 of reference (a) and the requirements in reference (b).
- g. Inspection, storage, care, and maintenance of **[NAVY or MARINE CORPS Activity]** Personal Fall Protection Equipment shall comply with the requirements of paragraph 1312 of reference (a); the requirements in reference (b); and the inspection, storage, care and maintenance instructions by the Fall Protection equipment manufacturers.
- h. Falls-from-heights mishaps experienced by **[NAVY or MARINE CORPS Activity]** personnel shall be reported if they meet the reporting criteria of reference (d). When fall-arrest equipment used by **[NAVY or MARINE CORPS Activity]** personnel is deployed or activated during a fall, it shall be reported as a fall-mishap using the Hazard Report in reference (e).
- i. Paragraph 1304.d. of reference (a) requires a *“Fall Protection and Prevention Plan”* prepared as part of a managed Fall Protection program when fall-arrest/restraint or positioning systems are used to provide Fall Protection. For routine and predictable tasks a site-specific *“Fall Protection and Prevention Plan”* shall be prepared and used.

For non-routine, infrequent and emergency tasks, where personal fall protection systems are used, **[NAVY or MARINE CORPS Activity]** personnel may prepare and use a generic *“Fall Protection and Prevention Plan”* for the type of **[NAVY or MARINE CORPS Activity]** work **[unprotected side or edge of a building, structure, crane or equipment]** being climbed or accessed at heights **(e.g. equipment on roofs, towers, poles, portal crane, floating crane, overhead traveling crane, mobile crane, etc.)**. The site-specific and generic plan shall be prepared in advance either by a Competent Person (CP) for Fall Protection or a Qualified Person (QP) for Fall Protection as defined in chapter 1306 of reference (a). For a sample *“Fall Protection and prevention plan”*, see section 7.2.3 or utilize the checklist in section 7.2.4 of reference (b) and include it as enclosure (1) of the written Fall Protection program. Paragraph 1307 of reference (a) requires each Navy activity to survey the workplace to identify potential Fall-Hazards and prepare *“Fall-Hazard survey report”*. For sample *“Fall-Hazard survey report”* see section 5.4 or utilize the checklist in section 5.5 of reference (b) and include it as enclosure (2) of the written Fall Protection program. Prior to visiting a site at another Navy Activity, **[NAVFAC Activity]** employees who will be climbing or accessing equipment to conduct inspection, maintenance or repair work at heights shall review the Navy Activity’s *“Fall-Hazard Survey Report”* for the **[crane/equipment being climbed or roofs and other work areas at heights]**. **[NAVY or MARINE CORPS Activity]** pre-visit letters sent to the activity in advance of scheduled visits is a method that can be used to obtain a copy of the Navy Activity’s *“Fall-Hazard Survey Report”*. If the *“Fall-Hazard Survey”* or knowledge from previous site visits indicates that there are Fall-Hazards unique to the particular **[crane, equipment, roof, tower etc.]** being climbed or accessed (e.g. walkways or platforms without OSHA compliant guardrails, missing swinging gates or chains, OSHA noncompliant step-across opening, etc.); then the generic *“Fall Protection and Prevention Plan”* shall be modified by the employee or other team leader in consultation with the Competent Person for Fall Protection addressing, eliminating, preventing or controlling these specific Fall-Hazards, thus becoming a site-specific *“Fall Protection and Prevention Plan”*.

j. Following a fall from a height, the end-user of Fall Protection, who is wearing a full-body harness that is properly secured to an anchorage, may be suspended in the harness for a length of time, if self-rescue or rescue by co-workers cannot be performed quickly. Sustained immobility in a body harness may lead to suspension trauma also known as harness-induced pathology as described in reference (b). Suspension trauma results from the accumulation of blood in the veins commonly called venous pooling. The symptoms (known as orthostatic intolerance) of suspension trauma include light-headedness, dizziness, weakness, and occasionally, fainting. The reduction in quantity and/or quality (oxygen content) of blood flowing to the brain leads to unconsciousness and harmful effects to other vital organs. If these conditions continue, they potentially may be fatal. **[NAVY or MARINE CORPS Activity]** end-users of Fall Protection shall be trained in the methods for minimizing the effect of delaying suspension trauma if an end-user is suspended in a body harness and unable to perform a self-rescue, and needs to wait to be rescued (e.g., keep legs moving and raise knees into the body to

July 2017

help prevent the pooling of blood in the legs). **[NAVY or MARINE CORPS Activity]** employees shall carry, attached to their full-body harness, two deployable suspension trauma step-in safety straps furnished to them as part of their Fall Protection gear. These safety straps allow employees suspended in a body harness after a fall to insert their feet and stand up to relieve the pressure of harness straps on their thighs, and helps blood circulation until rescued. **Note:** These straps are safety devices that will help under ideal conditions. They cannot be solely relied upon - there might be a situation where an injury or medical condition occurs before or during the fall, incapacitating the employee suspended in the full body harness, thus not allowing the use of the suspension trauma step-in safety strap. In this situation, the rescue plan shall include requirements for additional rescue and evacuation procedures.

k. Paragraph 1312 of reference (a) states that “When personal fall-arrest systems are used, the Navy activity must ensure that the mishap victim can self-rescue or can be rescued promptly should a fall occur.” **[NAVY or MARINE CORPS Activity]** personnel performing work at different Navy activities where the capabilities of the jurisdictional public or Government-emergency response agencies to rescue an employee suspended in a full body harness after a fall vary greatly; therefore prior to visiting a site at a Navy Activity, **[NAVY or MARINE CORPS Activity]** employees who will be using fall-arrest equipment shall review the Navy Activity’s “*Fall-arrest Rescue Plan*” for the site location of the **[crane equipment, tower and other structures]** being climbed. A **[NAVY or MARINE CORPS Activity]** pre-visit letter sent to the activity in advance of a scheduled visit is a method that can be used to obtain a copy of the Navy Activity’s “*Fall-arrest Rescue Plan*”. If the Navy Activity’s “*Rescue Plan*” does not show that the jurisdictional public or Government-emergency response agencies, or an alternative/supplemental rescue method (e.g., a man-lift with a readily available operator) can rescue an employee suspended in a body harness after a fall within 10–15 minutes; then **[NAVY or MARINE CORPS Activity]** employee(s) shall not climb or access that **[crane/equipment/tower/pole]** if climbing or accessing that **[crane/equipment/etc.]** requires the use of fall-arrest equipment. For a sample “*Fall-arrest Rescue Plan*,” see section 10.14, and include it as enclosure (3) to the written Fall Protection program.

**[NAVY or MARINE CORPS Activity]** Assigned Personnel for the Fall Protection program:

**Assigned Fall Protection Program Manager:** \_\_\_\_\_

**Designated Competent Person for Fall Protection:** \_\_\_\_\_

**(Signature \_\_\_\_\_)**  
**Commanding Officer**

Copy to:

End of Section

### 3.3 FALL PROTECTION PROGRAM COMPLIANCE and AUDIT CHECKLIST

<p><b>OPNAVINST 5100.23 Series, CHAPTER 13, or NAVMC DIR 5100.8, Chapter 18</b>  <b>FALL PROTECTION PROGRAM/AUDIT CHECKLIST</b>  <b>COMPLIANCE CHECK LIST</b>  <b>For</b>  <b>COMMANDS HAVING PERSONNEL PERFORMING WORK AT HEIGHTS, EXPOSED</b>  <b>TO FALL-HAZARDS AND USING FP EQUIPMENT</b></p>		Date of Audit:		
Unit		Command		
Prepared/Audited by (Signature)		Location		
<b>FALL PROTECTION PROGRAM Policy (Par. 1303/18000)</b>		<b>Yes</b>	<b>No</b>	<b>N/A</b>
<p>1 Does the Command have personnel working at heights, exposed to Fall-Hazards above 4 feet, and using Fall Protection (FP) Equipment?</p> <p>Is there a possibility of a fall from any height onto dangerous equipment, into a hazardous environment, or onto an impalement hazard?</p> <p>Is there any need to deviate from the 4-foot threshold height requirement (5 foot for Shipyard Operations)? Is this deviation approved by the Command Competent Person for Fall Protection?</p> <p>If the answer to the above is <b>yes</b>, a Fall Protection program is required to be established and implemented.</p>				
<b>BASIC PROGRAM REQUIREMENTS (Par. 1304/18003)</b>				
2 Is the Fall Protection program written and approved by the activity safety office?				
<p>3 As an alternate to the written Fall Protection program, is the Activity using the DON Fall Protection guide as their program with Safety Office review and approval?</p> <p>If using the guide as the Activity Fall Protection program, is the site specific fall protection requirements and information included?</p>				
<b>ACTIVITY POLICY (ADDITIONAL REQUIREMENTS) (Par.1305)</b>				



4	Is there a need for the activity to have additional supplementary requirements above and beyond the requirements stated in OPNAVINST 5100.23 Series, Chapter 13?			
<b>DUTIES AND RESPONSIBILITIES (Par.1306/18002)</b>				
5	Did the Command delineate duties and assigned responsibilities for personnel involved in the Fall Protection program, including Program Manager, Competent and Qualified Persons for Fall Protection, in the implementation of a managed Fall Protection program?			
6	Are the assigned personnel trained IAW OPNAVINST 5100.23 Series and have the necessary skills, knowledge and expertise to manage, administer and implement the Fall Protection program safely?			
<b>WORKPLACE SURVEYS AND ASSESSMENT OF FALL-HAZARDS (Par.1307/18002.b)</b>				
7	Has a survey been conducted for each Fall-Hazard at existing buildings, facilities or structures, and a Fall-Hazard Survey Report prepared?			
8	Was Fall-Hazard analysis performed to determine the risk assessment, hazard severity, and fall mishap probability in accordance w/OPNAVINST 5100.23, Series, Chapter 12?			
9	Is one or more Fall Protection methods identified in the survey report to eliminate, prevent or control each Fall-Hazard?			
10	Do the surveyed walking/working surfaces have the structural integrity to support the workers safely (e.g., working on roofs or platforms)?			
11	For personnel conducting inspection and investigation work of roof surfaces or inspecting and investigating workplace conditions on roofs (e.g. maintaining mechanical equipment), have they received proper training to conduct the work safely, prior to accessing the roof?  Did the Safety Office approve accessing the roof?			
12	Has the Fall-Hazard survey and assessment been validated annually for comparison purposes?			
<b>FALL PROTECTION AND PREVENTION PLAN (Par. 1304.(a)/18002)</b>				
13	For personnel exposed to Fall-Hazards and using personal fall-protection equipment (not otherwise protected by passive Fall Protection system such as guardrails), has a Site-specific Fall Protection and Prevention Plan been prepared and submitted to the Safety Office for review and approval?  (It is recommended to prepare a generic Fall Protection and prevention plan for non-routine and infrequent tasks [e.g., emergency tasks]).			

	The plan shall be updated as conditions change, once every six months.			
14	<p>Is the Fall Protection and prevention plan prepared either by the designated competent or Qualified Person for Fall Protection?</p> <p>If the plan includes Fall Protection components or systems requiring direction, supervision, design calculations, or drawings by the Qualified Person for Fall Protection, is the name, qualifications and responsibilities of the Qualified Person shall be addressed in the plan.</p>			
15	Does the plan describe in detail the specific practices, equipment, methods and procedures to be used for the protection of workers from falling to a lower level, and the inspection requirements?			
<b>FALL-HAZARD PREVENTION AND CONTROL (Par.1308/18003)</b>				
<b>PREFERRED ORDER OF CONTROL MEASURES (Par. 1308.a/18003)</b>				
16	Have the Fall-Hazards been evaluated to determine the preferred order of control measures for selecting the appropriate Fall Protection method (i.e. elimination, prevention, or control)?			
17	Can Fall-Hazards be eliminated by alternate work methods or changing task(s) or process(s)?			
<b>SELECTION OF FALL PROTECTION MEASURE (Par. 1308.b/18003)</b>				
18	Is the most appropriate Fall Protection method selected, compatible with the type of work being performed?			
<b>STANDARD GUARDRAIL SYSTEMS (Par. 1308.b.(1)/18003)</b>				
19	When guardrails are used, do they comply with the specified requirements for height, strength and minimum material of construction?			
20	<p>When perimeter cables are used at unprotected sides or edges, as a method of attaching a lanyard to the cables and also used as guardrails, do they meet the design requirements for horizontal lifelines?</p> <p>Did the Qualified Person for Fall Protection design the system including anchorages of the horizontal lifeline system?</p>			
<b>SAFETY NET SYSTEM (Par 1308.b.(2)/18003)</b>				
21	Does the safety net installation meet the specified criteria and requirements, including the size of the mesh openings and the strength of the outer rope or webbing?			
22	Has the safety net been tested in a suspended position with 400 pounds test weight immediately after installation and under the supervision of a Qualified Person?			



23	If a safety net was relocated, repaired or left in place for more than 6 months, was it retested in suspension under the supervision of Qualified Person?			
24	Was the inspection of the safety net performed by a Competent Person per manufacturer's instructions and recommendations?			
25	Inspection of safely nets must be performed immediately after installation, weekly thereafter, and following any alteration or repair. Has the inspection been documented?			
<b>COVERS (Par.1308.b.(3)/18003)</b>				
26	If covers are used to cover a hole 2 inches or more in its least dimension, are they capable of withstanding without failure, at least twice the combined weight of the worker, equipment and material that will pass over it?  When temporary covers are used, are they secured in place and clearly marked or color coded?			
<b>WORK PLATFORMS (Par. 1308.b.(4)/18003)</b>				
27	When working from elevated work platform, is the platform equipped with guardrail or other Fall Protection system? Is the work platform maintained properly?			
<b>ACTIVE FALL PROTECTION SYSTEM [1308.b.(5)/18003]</b>				
<b>PERSONAL FALL ARREST SYSTEMS [Par. 1308.b.(5).(a)/18003]</b>				
28	Do all personal fall arrest systems and equipment used meet ANSI/ASSE Z359 Fall Protection Code/Product Standards?			
29	When selecting personal Fall arrest system, is the free-fall distance, total fall distance, available and required clearances taken into consideration?			
30	Do the snaphooks and carabiners used meet ANSI Z359.12 standard?  (Snaphooks and carabiners meeting ANSI Z359.1-1992(R1999) shall not be used.)			
31	For workers having body weight outside the capacity range of 130-310 lbs. and using Personal Fall Protection equipment, is it permitted in writing by the manufacturer?			
32	If it is necessary to increase the free-fall distance beyond 6 feet (e.g. Tying at the feet level) and limiting the maximum arresting force on the body under 1,800 lbs., is the Qualified Person for Fall Protection making this determination?  There are two types of energy absorbing lanyards, the 6 ft. free fall and 12 ft. free fall. When the tie off point is located above the dorsal D-ring use the 6 ft. free fall energy absorbing single or "Y" lanyards. When the tie-off point is located below the dorsal D-ring, use the 12 ft. free-fall energy absorbing single or "Y" lanyards.			

<p>33 If the sternal D-ring attachment point on the full body harness (located at the sternum) is used as an alternate fall arrest attachment in applications where the dorsal attachment is determined to be inappropriate by the competent person for fall protection and where there is no chance to fall in a direction other than the feet first?</p> <p>For fall-arrest, is the worker exposed to a free-fall distance of less than two feet?</p>			
<p>34 Is the proper Self Retracting Device (SRD) selected and used, taking into consideration if the equipment is used in a horizontal or vertical application?</p> <p>There are four types of manufactured SRDs, self-retracting lanyard (SRL) used only in vertical applications, SRL with leading edge Capability used in vertical and horizontal applications, SRL for rescue and a hybrid component of any two of the above SRDs.</p>			
<p>35 When using “Y” lanyard for 100% tie-off, does the joint between the two legs of the lanyard withstand a force of 5,000 lbs.?</p>			
<p>36 The unused leg of the “Y” lanyard shall not be attached to any part of the harness, except to attachment points specifically designated by the manufacturer. Has the manufacturer of the equipment designate such attachment points (Full body Harness shall be equipped with at least one Lanyard Parking Attachment Element)?</p>			
<b>RESTRAINT SYSTEM [Par. 1308.b.(5)( b)/18003]</b>			
<p>37 In a restraint system, the end user must be using a full body harness and the proper length of the lanyard. Does the lanyard used have the proper length to prevent the worker from reaching the unprotected side or edge?</p> <p>When using a restraint system, is the lanyard length short enough (or adjustable) to prevent a worker from being exposed to a Fall-Hazard?</p>			
<b>POSITIONING SYSTEM [Par. 1308.b.(6)/18003]</b>			
<p>38 When using a positioning system, is the worker using a separate system (secondary system) that provides back-up protection from a fall?</p> <p>When using a positioning system, is the lanyard length short enough (or adjustable) to prevent a worker from being exposed to a fall more than two feet?</p>			
<b>CLIMBING LADDER FALL ARREST SYSTEM [Par. 1308.b.(7)]</b>			
<p>39 When using climbing-ladder FA System for ascending or descending on fixed ladders, is the distance between the connection point of the body harness and the rail or cable 9 inches long?</p> <p>Will the system stop the fall within two feet from the onset of a fall?</p> <p>Prior to installation, has the ladder (to which the climbing device will be attached),</p>			

	been designed to withstand the forces generated by the fall of the climber?			
	<b>OTHER ENGINEERED FALL PROTECTION SYSTEM [Par. 1308.b.(8)]</b>			
40	<p>Are commercially available engineered/integrated Fall Protection systems designed, installed, certified and used only under the supervision of QP and used per manufacturer instructions and recommendations?</p> <p>Did the CP may (if deemed appropriate by a QP), supervise the assembly, disassembly, use and inspection of the engineered system, under the direction of the QP and the design included drawings, required clearance, instructions on proper installation, use and inspection requirements?</p>			
	<b>PERSONAL FALL PROTECTION<sup>1</sup> EQUIPMENT SELECTION CRITERIA (Par. 1309/1802)</b>			
41	<p>Does the selected personal fall protection equipment meet the latest ANSI Z359 Fall Protection Code/Standards?</p> <p><b>(Any equipment meeting ANSI A10.14 and ANSI Z359.1 1992(R1999) shall not be used)</b></p> <p>Electrically rated harnesses shall meet ASTM F887 Standard.</p>			
42	Can the manufacturer of the selected equipment substantiate thru Third-Party Testing Laboratories, Witness Testing by a Professional Engineer, or Manufacturer Self-Certification Testing, that the equipment meets ANSI Z359 Fall Protection Code/Standards and/or designed, selected and approved by the Qualified Person for Fall Protection?			
	<b>TRAINING (Par. 1310/18004)</b>			
43	Does the Is Fall Protection training for all personnel involved in the Fall Protection program comply with OPNAVINST 5100.23, Appendix 13-A, DON Fall Protection Guide and ANSI Z359.2 Standard?			
44	Are workers trained by a Competent Person for Fall Protection who is qualified to deliver the training on the safe use of Fall Protection and rescue equipment, including hands-on and practical demonstrations and in accordance with the requirements in Appendix 13-A of OPNAVINST 5100.23?			
45	Did the assigned Competent and Qualified Persons for Fall Protection receive adequate training IAW Appendix 13-A of OPNAVINST 5100.23?			
46	Did other personnel involved in the Fall Protection program receive adequate training as required by the fall protection program manager?			
47	Has the above training been documented and verified with a certificate of training?			
48	Did end-users receive refresher/update training on the safe use of Fall Protection			

<p>equipment once every two years?</p> <p>Did the Competent Person for Fall Protection receive refresher/update training to stay current with the Fall Protection and educational requirements once every two years?</p> <p>Did other personnel involved in the Fall Protection program receive recommended or required refresher/update training as specified in Appendix 13-A and ANSI Z359.2 standard?</p>			
<p><b>ANCHORAGES FOR PERSONAL FALL PROTECTION EQUIPMENT (Par. 1311/18003)</b></p>			
<p>49 For certified fall arrest anchorages selected/identified and designed by a Qualified Person for Fall Protection, are they capable of supporting at least twice the maximum arresting force?</p> <p>For non-certified fall-arrest anchorages selected by a Competent Person for Fall Protection, are they capable of supporting a minimum force of 5,000 pounds per person attached?</p>			
<p>50 For non-certified restraint anchorages selected by a Competent Person for Fall Protection, are they capable of supporting 1,000 pounds per employee attached?</p> <p>For non-certified positioning, climbing ladder fall-arrest system and rescue anchorages selected by a Competent Person for Fall Protection, are they capable of supporting 3,000 pounds per employee attached?</p> <p>For Certified restraint, positioning and climbing ladder fall-arrest system anchorages, are they selected, identified and designed by a Qualified Person for Fall Protection, meeting the requirement of two times the foreseeable force on the worker?</p> <p>If needed, are certified anchorages for assisted rescue and self-rescue designed for 5 times the intended loading by a qualified person?</p>			
<p>51 Are the certified horizontal lifeline anchorages designed by a registered professional engineer with experience in designing HLL systems; or designed by a Qualified Person for Fall Protection who has appropriate knowledge, training and experience?</p> <p>Non certified anchorages are not permitted for HLL System.</p>			
<p><b>RESCUE PLAN AND PROCEDURES (Par. 1312/18002)</b></p>			
<p>52 For personnel working at heights and using fall-arrest equipment, has a site-specific Fall-hazard rescue plan and procedures been prepared and maintained at the work location?</p>			
<p>53 If self-rescue or assisted-rescue are the planned methods to be used during rescue, did the personnel conducting rescue receive adequate training?</p>			
<p>54 If required, are independent anchorages for rescue identified and selected?</p>			

55	If the method of rescue will be conducted by the jurisdictional public and Government-emergency response agencies, has a pre-incident plan been developed?			
<b>INSPECTION OF PERSONAL FALL PROTECTION EQUIPMENT (Par. 1313/18002)</b>				
56	Have procedures been established for inspection, storage, care and maintenance of the equipment IAW manufacturer's instructions and recommendations or 3-M maintenance system, whichever is more stringent?			
57	Does the Competent Person for Fall Protection inspect the Fall Protection equipment at least annually and w/documentation?  It is recommended the CP inspect the equipment semi-annually.			
58	Does the end-user inspect the equipment prior to each use?			
59	Is the equipment stored, cared for and maintained IAW References 13-1, 13-5 and with manufacturer instructions and recommendations?			
<b>FALLS FROM HEIGHTS MISHAP REPORTING (Par. 1314/MCO P5102.series)</b>				
60	Are falls-from-heights mishaps reported in accordance with the reporting criteria of OPNAVINST 5102.1D/MCO P5102 (series)?			
<b>EVALUATION OF PROGRAM EFFECTIVENESS (Par. 1315)</b>				
61	Are procedures in place to audit and evaluate the Fall Protection program, at least once every two years IAW reference 13-1?			

**End of Section**

### **3.4 Step By Step How to Establish, Manage and Implement a Fall Protection Program**

The following is a step by step procedure for establishing managing and implementing a fall protection program, arranged in a chronological order:

1. **Assign Fall Protection Program Manager and designate Competent Person for Fall Protection;**
2. **Train the Fall Protection Program Manager and Competent Person for Fall Protection;**
3. **Program manager develop written FP program, safety office review and approval is required;**
4. **Conduct fall hazard surveys and assessment and develop survey report;**
5. **Select type of FP system(s) and FP method(s) to be used;**
6. **Develop site specific Fall Protection and Prevention Plan (If personal fall protection system is the planned method). The plan shall be developed either by the Competent Person or Qualified Person for Fall Protection;**
7. **FP equipment programming and purchases;**
8. **Identify and train End Users on the use of FP equipment. Training shall be conducted by a competent person;**
9. **Establish FP equipment storage area and develop requirements for care, maintenance and inspection procedures IAW manufacturer's instructions and recommendations;**
10. **Competent person select/identify and use of non-certified anchorages. A Qualified Person will design the certified anchorages. A Competent person can install, use and inspect certified anchorages under the direction of the qualified person;**
11. **Develop rescue plan and procedures;**
12. **Conduct refresher/update training as required;**
13. **Audit the program.**

### **3.5 Audits and Evaluations**

The managed fall protection program shall be evaluated by the fall protection program manager at periodic intervals not to exceed two years. The program evaluation must identify strength and deficiencies for each element of the fall protection program along with recommendation for Improvements. The evaluation must be documented. See Paragraph 3.3 for Fall Protection Program Compliance and Audit Checklist.

End of Section

## **4.0 DUTIES AND RESPONSIBILITIES**

Navy and Marine Corps Commands shall delineate duties and assign responsibilities to the qualified and trained personnel involved in the development management and implementation of the Fall Protection program. Navy and Marine Corps activities shall ensure that assigned personnel have the necessary skills, knowledge, training and expertise to manage, administer, and implement the Fall Protection program.

### **4.1 QUALIFIED PERSON (QP) FOR FALL PROTECTION**

The duties and responsibilities of the Qualified Person for fall protection include the following:

- Responsible of supporting the Fall Protection program
- Prepare, review, approve, and modify:
  - Fall Protection and Prevention Plans;
  - Fall-Arrest Rescue Plans and procedures;
- Design, select, certify, evaluate, and analyze Fall Protection Systems and Equipment;
- Supervise the design, selection, installation and inspection of certified and non-certified anchorages, horizontal lifelines and other engineered fall protection systems;
- Involve in the evaluation and determination of fall-arrest system usage when the free-fall distance exceeds 6 feet;
- Calculate actual personal energy absorber deployment distances, the actual arrest distances of the self-retracting device and required clearance;
- Review, prepare, and approve Fall Protection Project Specifications;
- Prepare contract documents for Fall Protection systems.
- Knowledgeable with all the Fall Protection standards and regulations;
- The Qualified Person shall also meet the qualification of a Competent Person.

### **4.2 COMPETENT PERSON FOR FALL PROTECTION**

The duties and responsibilities of the Competent Person for fall protection shall include the following:

- Responsible for immediate supervision, implementation and monitoring of the Fall Protection program;
- Preparation and Implementation of:
  - Fall Protection and Prevention Plans;
  - Fall-Arrest Rescue plans and procedures;
- Identify Hazardous and Dangerous Conditions in the workplace and has the authority to take prompt corrective measures to correct them;
- Conduct Fall-Hazard survey and prepare survey and assessment report;
- Inspection and installation of approved fall-protection systems;
- Compliance with Fall Protection and Prevention Plans and Fall-Arrest Rescue Plans;



July 2017

- Ensures end-users working at heights and using Fall Protection equipment are adequately trained;
- Supervise the selection, installation and inspection of non-certified anchorages;
- Supervise the installation, use and inspection of certified anchorages, under the direction of the qualified person for fall protection;
- Have knowledge and understanding of Fall Protection systems and equipment;
- Conduct inspection and accident investigations;
- Have full responsibility and authority to implement the Fall Protection and Prevention Plans and Fall-Arrest Rescue Plans and Procedures;
- Knowledgeable with all the Fall Protection regulations and standards;
- Monitor employee compliance with Fall Protection and Prevention Plan and Fall-Arrest Rescue Plan requirements.

### **4.3 FALL PROTECTION PROGRAM MANAGER**

The duties and responsibilities of the Program Manager include but not limited to the following:

- Developing, implementing and managing the Fall Protection program at the activity;
- Ensures all personnel exposed to Fall-Hazards and using Personal Fall Protection equipment are adequately trained before using the equipment
- Ensures other personnel involved in the Fall Protection program are adequately trained;
- Develop overall Fall Protection training programs;
- Develop and approve equipment purchase list;
- Ensure fall protection and prevention plan and rescue plan and procedures are developed for every work place location where active fall protection system is used.
- Evaluate Fall Protection program effectiveness.

The Fall Protection Program Manager through training, knowledge and expertise should be able to identify, evaluate and address existing and potential Fall-Hazards.

**End of Section**

## **5.0 WORKPLACE SURVEYS AND ASSESSMENT OF FALL-HAZARDS**

### **5.1 FALL-HAZARD SURVEY**

Each Navy and Marine Corps activity shall ensure that a survey of the workplace is conducted to identify potential Fall-Hazards in accordance with Chapter 5 of OPNAVINST 5100.23 Series or Chapter 1 MCO 5100.29 Series. Navy and Marine Corps activities shall determine whether the walking or working surfaces on which employees are to work on, have the strength and structural integrity to support the workers safely. Employees shall not be permitted to work on those surfaces until it has been determined that the surfaces have the requisite strength and structural integrity to support the workers and equipment related to their task(s). Once it has been determined that the surface is safe for employees to work on, then it should be determined if a Fall-Hazard exists at the work location.

A Fall-Hazard Survey will help identify potential Fall-Hazards at the workplace. The gathered information will provide documentation to assist in the development of viable solutions to protect personnel exposed to Fall-Hazards. Understanding work procedures and how a person conducts the required task is very important in the selection and development of the most appropriate Fall Protection method. A Fall-hazard survey will help to identify options for fall-hazard elimination and/or selection of other control measures. **The Fall-Hazard survey shall be validated annually for comparison purposes.**

The command or activity to which personnel exposed to fall hazards belong to is responsible for the survey of those activities which expose those personnel to the fall hazard. At location that multiple commands personnel may be exposed to the same fall hazard, the installation shall coordinate the survey efforts in order to save resources.

**The survey information, required for identification of Fall-Hazards at existing buildings or facilities should include:**

- a. Interview of workers and their supervisors;
- b. Work-paths and movement of the workers;
- c. Range of mobility in each fall-hazard zone;
- d. Location and Distances to Obstructions;
- e. Potential anchorage Location, if a Fall-Hazard cannot be eliminated or prevented;
- f. Available clearance and total fall distance.
- g. Number of personnel exposed to Fall-Hazards.
- h. Frequency and duration of exposure.
- i. Lock-Out/Tag-Out hazards.
- j. Potential severity of the fall.
- h. Access or egress to fall-hazard area.
- k. Condition of floors and other surfaces.
- l. Review of any fall mishap reports at the facility.

- m. Identify the presence of any:
- Hot objects, sparks, flames, and heat-producing objects
  - Electrical and chemical hazards
  - Sharp objects
  - Abrasive surfaces
  - Moving equipment and materials
  - Impact of weather factors
  - Any other maintenance or work environment issues or conditions

**If employees from another activity visit and perform work at the Navy activity where the worksite is located (e.g. Navy or Marine Corps I.G., Audit Teams, Naval Facilities Engineering Command, Navy Crane Center, Inspection Teams, etc.) and encounter Fall-Hazards or potential Fall-Hazards, the visiting team/employee shall be responsible for conducting the subject workplace survey for the specific hazard(s) encountered and provide a report to the Navy or Marine Corps activity Safety Office for the location being visited. The visiting employees shall not perform work at the worksite where there is a fall hazard, unless the hazard has been mitigated, or a Fall Protection solution and/or solution to other encountered hazards, be provided.**

When conducting inspection, assessment and investigation work on existing roofs systems or conducting Fall-Hazard surveys, Navy personnel shall perform their work in a safe manner. Navy personnel shall receive the proper training prior to accessing the roof and understand all the required safety precautions and requirements for conducting their work safely. **For roof inspection and investigation work requirements, see Chapter 16 of this Guide.**

## **5.2 FALL-HAZARD ASSESSMENT**

After a Fall-Hazard survey is conducted at a workplace, a hazard analysis can be performed to assess the risk, hazard severity, and fall mishap probability in accordance with the requirements in OPNAVINST.5100.23 series and MCO 5100.29 series or NAVMC DIR 5100.8. This will help in prioritizing of hazard ranking and selection of the most viable Fall Protection solutions.

**The primary consideration is to eliminate/remove potential Fall-Hazards from the work place.**

## **5.3 REQUIREMENTS FOR FALL-HAZARD SURVEY REPORT**

### **Instructions for conducting a survey and preparing survey report**

1. The Survey shall be conducted for each Fall-Hazard to which a person may be exposed to.

July 2017

2. Identify one or more methods to eliminate or control Fall-Hazards.
3. A person who is familiar with building operations and work procedures, and with access to information regarding work processes, environment, policy and best practices should accompany the individual conducting the survey.
4. The survey should include pertinent information as to the type of Fall-Hazard showing basic configuration (graphic/drawings/photos).
5. The report shall identify environmental factors that may affect the building/facility.
6. Establish risk factors to assist in the hazard ranking.
7. Revise the report whenever there is a change in work procedure/task equipment or requirements that will render the previous report obsolete.
8. Interview personnel that will be working at heights and exposed to Fall-Hazards.

Note:

The survey can be conducted by the Program Manager or the Competent Person for Fall Protection. The Competent Person can train and delegate another person to conduct the survey.

For a Sample Survey Report, see paragraph 5.4 or for survey checklist see paragraph 5.5

End of Section

July 2017

## 5.4 SAMPLE FALL-HAZARD SURVEY REPORT For Specific Work Location

### General information

Activity/Command: \_\_\_\_\_ Page # \_\_\_\_\_

Building/Facility # \_\_\_\_\_ Date: \_\_\_\_\_

Department: \_\_\_\_\_

Work Area: \_\_\_\_\_

Survey Conducted by: \_\_\_\_\_

Accompanied by: \_\_\_\_\_

### Survey Data

- Fall-Hazard Zone and Type (Description): \_\_\_\_\_
- Work Location: \_\_\_\_\_
- Personnel interviewed: \_\_\_\_\_
- Applicable regulations/Standards: \_\_\_\_\_
- Type of work performed: \_\_\_\_\_
- How close is the person to the Fall-Hazard? \_\_\_\_\_
- Location and distance to obstructions: \_\_\_\_\_
- Suggested anchorage location, if Fall-Hazard cannot be eliminated or prevented:  
\_\_\_\_\_
- Available clearance and total fall distance: \_\_\_\_\_
- Number of personnel exposed to Fall-Hazard: \_\_\_\_\_
- Frequency and duration of exposure: \_\_\_\_\_
- Exposure rating: High \_\_\_\_\_ Medium \_\_\_\_\_ Low \_\_\_\_\_
- Potential severity of a fall: \_\_\_\_\_
- Any obstructions in the potential fall path: \_\_\_\_\_

July 2017

- Access or egress to Fall-Hazard area: \_\_\_\_\_
- Condition of floor or other surfaces: \_\_\_\_\_
- Review any mishap reports at the facility: \_\_\_\_\_
- Any chance of slips trips and same level falls: Yes \_\_\_\_ No \_\_\_\_
- Lock-Out/Tag-Out hazard: \_\_\_\_\_
- Floor/surface condition: \_\_\_\_\_

• **Identify the presence of:**

- Hot objects: \_\_\_\_\_
- Sparks: \_\_\_\_\_
- Flames: \_\_\_\_\_
- Heat producing objects: \_\_\_\_\_
- Any electrical/Chemical/RF Transmitter hazards: \_\_\_\_\_
- Sharp objects: \_\_\_\_\_
- Abrasive surfaces: \_\_\_\_\_
- Any moving equipment in the area: \_\_\_\_\_
- Impact of weather factors: \_\_\_\_\_
- Other maintenance work environment/issues: \_\_\_\_\_

• **Suggested Fall Protection Solutions:**

Select two of the following probable solutions

- Guardrails \_\_\_\_\_
- Safety nets \_\_\_\_\_
- Fall-arrest system \_\_\_\_\_
- Travel Restraint system \_\_\_\_\_
- Work positioning system \_\_\_\_\_
- Horizontal lifeline system/Single anchor vertical lifeline \_\_\_\_\_
- Aerial lift equipment/work platforms \_\_\_\_\_
- Warning line system/Designated Area Method \_\_\_\_\_
- Climbing Ladder Fall-Arrest System \_\_\_\_\_
- Raising/lowering devices \_\_\_\_\_
- Covers \_\_\_\_\_

If fall-arrest/restraint/work positioning/Horizontal lifeline/Single Anchor Vertical Lifeline system is selected:

- Anchorage(s) location (if any): \_\_\_\_\_
- Can rescue be performed if required: \_\_\_\_\_
- Type of rescue: \_\_\_\_\_

July 2017

- Any potential swing Fall-Hazards: \_\_\_\_\_
  - Is the end-user properly trained: Yes \_\_\_\_ No \_\_\_\_
  - Other factors: \_\_\_\_\_
  - Fall-Hazard assessment per OPNAVINST 5100.23 Series, chapter 13, or NAVMC DIR 5100.8.
- 
- 

- Any additional information:
- 
- 

- Drawings/Sketches/Photos

- Prepared by: \_\_\_\_\_

- Approved by: \_\_\_\_\_

**Note:**

**The above sample survey report is for a single Fall-Hazard location. For a complete survey report at a building, facility, or activity, develop a summary table for all Fall-Hazards and attach the specific survey reports to it.**

**End of Section**



July 2017

## 5.5 Site-Specific Fall Hazard Survey Report Checklist

<i>GENERAL INFORMATION</i>				
Activity/Command:		Date:		
Building/Facility #:		Work Area:		
Survey Conducted By:		Approved By:		
Fall-Hazard # (1, 2, 3, etc.)		FP Program Manager or Competent Person:		
<i>SURVEY INFORMATION</i>				
Major Fall-Hazard Zone or Type:		Work Location:		
Personnel Interviewed:	1.	Guiding Regs:		
	2.	Work Type:		
	3.			
Distance of Personnel from Fall-Hazard (Ft):		Location or Distance to Obstructions (Ft)?		
Suggested Anchorage(s) (if fall-arrest system utilized):				
Distance to Ground Below (Ft):		Number of Personnel Exposed to Fall-Hazard:		
Frequency/Duration of Fall Exposure:	/	Exposure Risk:		
Potential Severity of Fall:		Obstructions in Fall Path:		
Access or Egress to Fall-Hazard Area (i.e. ladder, AWP, Stairs, etc.)		Condition of Floor/Other Surfaces:		
Historical Fall Mishaps at the Facility?		Lock Out/Tag Out Hazard?		
Is There a Risk of the Following?		Suggested Fall Protection Solutions		
Hot Objects:	<input type="checkbox"/>	Guardrails		
Sparks:	<input type="checkbox"/>	FA Type:	Horizontal Life-Line	<input type="checkbox"/>
			Portable System	<input type="checkbox"/>
Overhead Beam Strap	<input type="checkbox"/>			
Self-Retracting Lanyard	<input type="checkbox"/>			
Energy Absorbing Lanyard	<input type="checkbox"/>			
Flames:	<input type="checkbox"/>	Maintenance Stand or work platforms	<input type="checkbox"/>	
Chemical Hazards:	<input type="checkbox"/>	Restraint System	<input type="checkbox"/>	
Electrical Hazards:	<input type="checkbox"/>	Positioning System	<input type="checkbox"/>	
Sharp Objects:	<input type="checkbox"/>	Aerial Lift/Work Platforms	<input type="checkbox"/>	
Abrasive Surfaces:	<input type="checkbox"/>	Horizontal or Single Anchor Vertical Lifeline System		
Weather Factor:	<input type="checkbox"/>	Other FP methods		
Other risk Factors:	<input type="checkbox"/>			
Anchorage(s) Locations (if Applicable)				
Can Rescue Be Performed if Required?		Type of Rescue:		
Is there a rescue plan prepared?		Explain Other:		
Are End-users Trained on Fall-arrest Systems?		Do Swing Fall-Hazards Exist?		
Additional Information				

**Note:**

**For complete Fall-Hazard survey of the facility, tabulate and develop summary of findings for all locations.**

**End of Section**

## **6.0 TRAINING**

### **6.1 TRAINING REQUIREMENTS**

- 6.1.1** All Navy and Marine Corps personnel working at heights, exposed to Fall-Hazards and using Fall Protection equipment, and other personnel involved in the Fall Protection program, shall be trained to recognize the hazards of falling in the workplace and how to eliminate, prevent or control such hazards IAW the training matrix in paragraph 6.2 and Appendix 13-A of OPNAVINST 5100.23 Series.
- 6.1.2** Before using Fall Protection equipment, the employee (end-user) must be trained on the safe use of the equipment. It is recommended that all employees (end-users) exposed to Fall-Hazards shall receive a minimum of 16 hours, or as appropriate, Fall Protection training including hands-on training and practical demonstrations. The end-user shall be trained by a person who has the knowledge, expertise and education to deliver the training. Hands-on training and practical demonstrations for the end-user shall be conducted by the Competent Person for Fall Protection.
- 6.1.3** Retraining shall be provided as necessary for employees to maintain an understanding of these subjects.
- 6.1.4** A written certification of training is required and shall be maintained at the job-site for the duration of the work. For those employees visiting from another Navy activity, they (end-users) shall carry the certificates (or pocket cards) with them. The certificate shall identify the name of the employee trained, date of training, and the signature(s) of the trainer(s). Additionally, a determination shall be made as to whether the training has resulted in personnel acquiring the required skills and knowledge.
- 6.1.5** The trained end users shall be reminded by the Competent Person for Fall Protection or their supervisors not to deviate from the procedures set forth by the competent person on the use of the equipment or methodologies without consulting with the Competent Person for Fall Protection.
- 6.1.6** It is highly recommended that a daily "Tool Box" meeting be conducted before start of the work shift to discuss Fall-Hazards for that day and to remind workers to comply with the established Fall Protection procedures.
- 6.1.7** For Navy or Marine Corps personnel who may be in a situation that requires climbing involving the use of fall-arrest systems, the End-user Training shall also include practice climbing in a controlled situation in the presence of a Competent Person. Additionally, end-users shall be trained in rescue and self-rescue equipment and procedures. A Competent Person who has the knowledge, expertise, qualification and education to deliver the training shall train end-users.

- 6.1.8** All Navy or Marine Corps architects, engineers, and in-house designers involved in planning and designing buildings, facilities, and structures, shall be trained to incorporate Fall Protection and prevention control measures into their designs to assist contractors during the construction phase to protect their workers and to provide protection to DON personnel performing their work during normal operation and maintenance phases. The training should emphasize that Fall-Hazards should be eliminated, and if this not be possible or practical, there must be a mechanism or a control measure in place for preventing or protecting workers from such hazards.
- 6.1.9** All DON Architects, engineers, and other inspectors conducting inspection, investigation and assessment work on existing roof systems and other work conditions (i.e. maintenance of mechanical equipment) shall be trained prior to gaining access to the roof, and to take precautionary measures to protect themselves and other members of the inspection team from Fall-Hazards.
- 6.1.10** In addition to the training requirements in this guide, the training for all personnel involved in the Fall Protection program – Program Manager, Qualified Person, Competent Person, End-user (Authorized Person), Authorized Rescuers, as well as any associated Fall Protection trainers, shall be as prescribed in ANSI/ASSE Z359.2 Standard.
- 6.1.11** All Fall Protection and rescue training, including refresher/update training, shall be developed and delivered according to the Needs Assessment. The Needs Assessment shall conform to the specific requirements of ANSI Z359.2 standard and in compliance with ANSI/ASSE Z490.1-2016 titled “Criteria for Accepted Practices in Safety, Health and Environmental Training.”
- 6.1.12** Training requirements for other personnel not listed in appendix 13-A of OPNAVINST 5100.23 Series and paragraph 6.2 of this guide, who are involved in the fall protection program, must be determined by the fall protection program manager.
- 6.1.13** The following training matrix requirements and methods identify the degree and extent of training for various Navy personnel including refresher/update training:

**End of Section**

## 6.2 TRAINING MATRIX

### FALL PROTECTION TRAINING REQUIREMENTS AND METHODS

Trainee GROUP	Desired Training Objectives	Training Mechanism and Type
End-user (Authorized Person)	<ul style="list-style-type: none"> <li>- Selection and safe use of equipment applicable to the scope of work</li> <li>- Application limits</li> <li>- Proper anchoring and tie-off techniques</li> <li>- Estimation of fall distances including total fall distance, free fall distance and clearance requirements</li> <li>- Determination of deceleration distance</li> <li>- Swing Fall Hazards</li> <li>- Methods of inspection</li> <li>- Storage, care, and maintenance of equipment</li> <li>- Applicable regulations and standards</li> <li>- Limitations of equipment</li> <li>- Specific lifelines</li> <li>- Rescue and self-rescue techniques</li> <li>- Recognize fall-hazard deficiencies</li> <li>- Recognize fall risks at worksite</li> <li>- Proper set-up and use of the designated area/warning line system.</li> </ul>	<p>Hands-on training and practical demonstrations (a must) for using local equipment or on-site training as applicable to the activity, delivered by the Competent person for FP</p> <p>Or</p> <p>ESAMS Course # 2018 titled Fall Protection Awareness Training for End Users Working at Heights and Supervisors of End Users, and ESAMS course 3024 titled Fall Protection Hands-On Training and Practical Demonstration Requirements for End Users</p> <p>(16 hours or as appropriate)</p> <p>Depending on the work task and the type of work being performed by the end user, the Command competent Person for Fall Protection will determine the extent and the duration of the required training including hands-on training the end user is required to be trained on.</p>
Construction	<ul style="list-style-type: none"> <li>- Recognize fall-hazard deficiencies</li> <li>- Recognize fall risks at worksite</li> </ul>	Fall Protection, part of

DEPARTMENT OF THE NAVY FALL PROTECTION GUIDE

July 2017

<p>Management Personnel</p>	<ul style="list-style-type: none"> <li>- Applicable rules and regulations</li> <li>- Fall protection program requirements, including roles and responsibilities and training requirements of personnel involved in the fall protection program</li> <li>- Applications and requirements of Fall Protection systems and equipment including guardrails, safety nets and covers:</li> <li>- Requirements of personal fall protection systems and equipment including:                         <ul style="list-style-type: none"> <li>• Applications and methods of use</li> <li>• Proper anchoring and tie-off techniques</li> <li>• Methods of inspection and record keeping</li> <li>• Storage of the equipment</li> <li>• Rescue equipment and procedures</li> <li>• Understand fall protection and prevention plan and rescue plan requirements</li> </ul> </li> <li>- Application and use of Aerial Work Platforms</li> <li>- Requirements of Warning Line/Designated Area</li> <li>- Requirements for working over water.</li> </ul>	<p>the 40 hours Construction Safety Training (USACE EM 385-1-1, Section 21).</p> <p>(Minimum 4 hours)</p>
<p>Contracting Officer Technical Representative and Contract Assurance Personnel</p>	<ul style="list-style-type: none"> <li>- Recognize fall-hazard deficiencies</li> <li>Recognize fall risks at a worksite</li> <li>- Various type of slips, trips and fall hazards encountered at workplaces</li> <li>- Causes that lead to slips, trips and fall mishaps on the same level, and</li> <li>- Recommended solutions to mitigate fall hazards and prevent fall mishaps</li> </ul>	<p>ESAMS Course #1259 titled Slips, Trips and Same Level Falls</p>
<p>Competent Person for Fall Protection (As Designated in writing by the Activity as the Command Competent Person)</p>	<p>In addition to the end-user training, the Competent Person for Fall Protection training shall include hands-on and practical demonstrations, and the following:</p> <ul style="list-style-type: none"> <li>- Implementation of various Fall Protection systems</li> <li>- Proper donning of the equipment</li> <li>- Proper inspection and record keeping</li> <li>- Recognition and identification of Fall-Hazards at work-site</li> <li>- Verification of proper equipment installation techniques</li> <li>- Confirmation of proper anchoring and tie-off techniques</li> <li>- Assessment of risk and hazard ranking</li> </ul>	<p>Competent Fall Protection Person</p> <p>NAVSAFENVTRACEN Course, CIN # A-493-0103 (ESAMS Course ID. 6198)</p> <p>Or</p> <p>As approved by ECHELON 2 IAW OPNAVINST 5100.23, Chapter 13. The training shall also be in</p>

DEPARTMENT OF THE NAVY FALL PROTECTION GUIDE

July 2017

	<ul style="list-style-type: none"> <li>- Preparation, updating, review and approval of Fall Protection and prevention plans, and rescue and evacuation plans</li> <li>- Assurance of understanding Fall Protection regulations and standards by personnel to be exposed to fall hazards</li> <li>- Review and approval of plans and specifications</li> </ul>	<p>compliance with the Competent Person for Fall Protection Course Syllabus included in Appendix F of this guide</p> <p>(Minimum 40 hours)</p>
<p>Qualified Person for Fall Protection</p>	<ul style="list-style-type: none"> <li>- Design, select, analyze, and certify Fall Protection systems and equipment including certified anchorages</li> <li>- Prepare, update, review, and approve Fall Protection and prevention plans, and rescue and evacuation plans</li> <li>- Assure understanding of Fall Protection regulations and standards by personnel to be exposed to fall hazards</li> <li>- Review and approve plans and specifications</li> </ul>	<p>As approved by ECHELON 2 IAW OPNAVINST 5100.23 Series, Chapter13</p> <p>(40 hours or as appropriate)</p>
<p>Architects and Engineers (Designers) involved in planning and design of buildings, facilities and structures</p>	<ul style="list-style-type: none"> <li>- Acquire knowledge and understanding of best practices and design considerations for management of fall hazards during construction and maintenance phases</li> <li>- Understand various fall protection and prevention planning and design considerations for management of hazards during construction and maintenance phases</li> <li>- Applicable fall protection regulations, standards, instruction and requirements</li> <li>- Understanding of various fall protection systems and equipment</li> <li>- Recognize design deficiencies affecting fall hazards</li> <li>- Recognize fall risk assessment and control measures at worksites</li> <li>- Identification and selection of certified and non-certified anchorages</li> </ul>	<p>(Awareness Training)</p> <p>ESAMS course 1900</p> <p>(4 hours)</p>
<p>Fall Protection Program Managers</p> <p>(Assigned by the Command)</p>	<ul style="list-style-type: none"> <li>- Recognize and identify Fall-Hazards at workplaces</li> <li>- Understand best practices, criteria and requirements for development and managing Fall Protection program</li> <li>- Risk assessment and hazard ranking</li> <li>- Understand and identify selection, safe use, and limitation of Fall Protection systems and equipment</li> <li>- Understand proper storage, care, and</li> </ul>	<p>As approved by ECHELON 2, IAW OPNAVINST 5100.23 Series, Chapter 13</p> <p>Or,</p> <p>ESAMS Courses #4437, Part 1 and 4438, Part 2 - Fall Protection Program</p>

DEPARTMENT OF THE NAVY FALL PROTECTION GUIDE

July 2017

	<p>maintenance of the equipment</p> <ul style="list-style-type: none"> <li>- Identify applicable Fall Protection regulations</li> <li>- Audit and evaluate program criteria</li> <li>- Understand duties, responsibilities and training requirements for personnel involved in the Fall Protection program</li> </ul>	<p>Managers Training</p> <p>Or</p> <p>NAVSAFENVTRACEN Course, CIN A-493-0099 (ESAMS Course ID 6360)</p> <p>Minimum 16 hours</p>
Aviation Fall Protection Program Managers	<p>Recognize and identify fall hazards at workplaces</p> <ul style="list-style-type: none"> <li>- Understand best practices, criteria and requirements for development and managing fall protection program associated with aviation</li> <li>- Risk assessment and hazard ranking</li> <li>- Selection, safe use, and limitation of fall protection systems and equipment</li> <li>- Conduct fall hazard survey and prepare survey report</li> <li>- Implement feedback under Naval Aviation Maintenance Program and T/M/S System Safety Working Groups</li> <li>- Understand duties, responsibilities and training requirements for personnel involved in the fall protection program</li> <li>- Provide end user training</li> </ul>	<p>ESAMS Course I.D. #4463</p> <p>Fall Protection Program Managers Training for CNAL and CNAP Wing/Squadrons</p> <p>16 hours In resident</p>
Aviation Competent Person for Fall Protection	<p>In addition to the end-user training, the Competent Person for Fall Protection training shall include hands-on and practical demonstrations, and the following:</p> <ul style="list-style-type: none"> <li>- Implementation of various Fall Protection systems used in aviation environment</li> <li>- Proper donning of the equipment</li> <li>- Proper inspection and record keeping</li> <li>- Recognition and identification of Fall-Hazards at work-site</li> <li>- Verification of proper equipment installation techniques</li> <li>- Confirmation of proper anchoring and tie-off techniques</li> <li>- Assessment of risk and hazard ranking</li> <li>- Preparation, updating, review and approval of Fall Protection and prevention plans, and rescue and evacuation plans</li> <li>- Assurance of understanding Fall Protection regulations and standards by personnel to be exposed to fall hazards</li> </ul>	<p>40 hours in resident, delivered via MPHA</p> <p>Or</p> <p>As approved by ECHELON 2, IAW OPNAVINST 5100.23 Series, Chapter 13</p>



DEPARTMENT OF THE NAVY FALL PROTECTION GUIDE

July 2017

<p>Afloat Fall Protection Competent Person and Program Manager</p>	<ul style="list-style-type: none"> <li>- Recognize and identify fall hazards at workplaces</li> <li>- Understand best practices, criteria and requirements for managing fall protection program in shipboard or shipyard environment</li> <li>- Understand duties, responsibilities and training requirements for personnel involved in the fall protection program</li> <li>-Provide familiarization training</li> <li>-Provide end user training</li> </ul> <p>In addition to the end user training, the competent person for fall protection training including hands-on and practical demonstrations, must also include:</p> <ul style="list-style-type: none"> <li>-Various fall protection systems</li> <li>- Donning of the equipment</li> <li>- Proper inspection and record keeping</li> <li>- Recognize and identify fall hazards at work-site</li> <li>- Proper anchoring and tie off techniques</li> <li>- Applicable fall protection regulations</li> <li>- Development of fall protection and prevention plan and rescue plan.</li> </ul>	<p>NAVSEA 32 hours</p> <p>Or</p> <p>40 hours in resident</p>
<p>Authorized Rescuer</p>	<ul style="list-style-type: none"> <li>-Use of applicable rescue systems and equipment;</li> <li>-Before use inspection of rescue equipment,</li> <li>-The use of belay devices, pulleys and winch systems</li> <li>-Descent control devices</li> <li>-Other applicable rescue systems and equipment.</li> </ul>	<p>Hands-on training and practical demonstrations (a must) for using local equipment or on-site training as applicable to the activity</p>

DEPARTMENT OF THE NAVY FALL PROTECTION GUIDE

July 2017

<p>Architects, Engineers and other Inspectors conducting inspection and Investigation work of roofs, General Industry workplace conditions or conducting Fall Hazard Survey</p>	<ul style="list-style-type: none"> <li>- Receive Fall Protection awareness training</li> <li>- Understand and utilize applicable regulations and standards</li> <li>- Emphasize responsibilities and basic duties of the inspection team</li> <li>- Emphasize safe work practices</li> <li>- Provide for and emphasize safe access</li> <li>- Use protective methods while conducting inspection and investigation work</li> <li>- Implement pre-climbing safety verification checks</li> <li>- Understand and implement procedures for conducting inspections and investigations</li> <li>- Apply training requirements</li> </ul>	<p>ESAMS Course #3639 titled Fall Protection Awareness Training for Architects, Engineers and other Inspectors involved in conducting Inspection, Investigation and Assessment Work on roofs</p>
<p>End-user(Authorized Person) Refresher/Update Training  (every 2 years)</p>	<p>Select and use of equipment safely</p> <ul style="list-style-type: none"> <li>- Understand and apply application limits</li> <li>- Employ proper anchor and tie-off techniques</li> <li>- Carefully estimate potential fall distances</li> <li>- Determine deceleration distance</li> <li>- Calculate total fall distance</li> <li>- Understand and apply proper methods of inspection</li> <li>- Apply requirements of proper storage, care, and maintenance of the equipment</li> <li>- Understand applicable regulations</li> <li>- Recognize limitations of equipment</li> <li>- Understand the use and limits of specific lifelines</li> <li>- Reinforce understanding of rescue and self-rescue techniques</li> <li>- Recognize fall-hazard deficiencies</li> </ul>	<p>Delivered by Competent Person for Fall Protection</p> <p>Or</p> <p>Receive ESAMNS Course #2018 titled Fall Protection Awareness Training for End Users Working at Heights and Supervisors of End Users</p> <p>(Competent Person determines if Hands-On training and practical demonstrations is required)</p>
<p>Refresher Training for the Competent Person for Fall Protection  (Every 2 years)</p>	<ul style="list-style-type: none"> <li>-Stay current with the Fall Protection and rescue educational requirements</li> <li>-Acquire knowledge and understanding of the best Fall Protection practices and application of fall protection and rescue equipment and systems,</li> </ul>	<p>Applicable technical seminars or web based Training</p> <p>Or</p> <p>Receive ESAMS Course # 4438 titled Competent and Qualified Person</p>

DEPARTMENT OF THE NAVY FALL PROTECTION GUIDE

July 2017

		<b>Refresher Training</b>
Refresher Training for the Qualified Person for Fall Protection	Stay current with the Fall Protection and rescue educational requirements	Applicable technical seminars, conferences or web based training  Or  Receive ESAMS Course # 4438 (part 2) titled Competent and Qualified Person Refresher Training
Refresher Training for the Fall Protection Program Manager	Stay current with the Fall Protection and rescue educational requirements	Applicable technical seminars, conferences or web based training  Or  Receive ESAMS Courses # 4437 (Part 1) and 4438 (part 2)
Other Personnel Involved in the Fall Protection Program (Whether exposed or not exposed to falls)		As determined by the Fall Protection Program Manager

**Note:**

If no access to ESAMS, above course curriculums may be provided by Mishap Prevention Hazard Abatement Program via [mpa.fct@navy.mil](mailto:mpa.fct@navy.mil)

**End of Section**

### 6.3 REFRESHER/UPDATE TRAINING

Personnel exposed to Fall-Hazards shall receive refresher/update training on the safe use of Fall Protection equipment and rescue as follows:

- **End-user, Competent Person for Fall Protection, Competent Rescuer and Authorized Rescuer** (Person who conducts rescue) Refresher/Update training is required, and shall be conducted at least every two years, to stay current with the Fall Protection and rescue educational requirements in accordance with paragraph 6.2.
  - The FPPM will evaluate and determine if the above personnel require refresher training annually.
- **FPPM and Qualified Person** shall receive refresher/update training every two years to stay current with the fall protection and rescue and educational requirements IAW Section 6.2 of this guide. ANSI Z359.2 recommends a minimum of 8 hours of continued education annually for the FPPM and QP refresher/update training.

### 6.4 RETRAINING

Retraining in relevant topics shall be provided to the end-user when:

- (1) The End-User has been observed using Fall Protection equipment in an unsafe manner;
- (2) The end-user has been involved in a mishap or a near-miss incident;
- (3) The end-user has received an evaluation that reveals that he or she is not using the Fall Protection equipment properly;
- (4) The end-user is assigned a different type of Fall Protection equipment; and/or
- (5) A condition in the workplace changes in a manner that could affect the safe use of the Fall Protection equipment that the end-user is to utilize.

### 6.5 AVAILABLE WEB-BASED FALL PROTECTION TRAINING COURSES

The following are the Fall Protection Web-Based training Courses posted on the Navy Enterprise Safety Management System (ESAMS). (Marine Corps activities must contact installation safety offices for available training).

**Initial Fall Protection Training:**

July 2017

- (1) End user and Supervisors of End Users Training;**
  - a. ESAMS Course #2018.**
  - b. ESAMS Course #3024: Outline for Hands-On Training and Practical Demonstrations requirements for End Users. This training complements course #2018. The training includes hands-on and practical demonstrations and shall be delivered by the Competent Person who is qualified to provide the training. The Competent Person for Fall Protection will determine the extent of the hands-on and practical demonstration for the end user which depends on the fall protection equipment and systems used and the work environment.**
  
- (2) All personnel**
  - a. ESAMS Course #1259 titled Slips Trips and Same Level Falls (awareness training).**
  
- (3) Architects/Engineers and other Inspectors conducting roof inspection investigation and assessment work and other maintenance personnel conducting inspection of work place conditions (I.e. mechanical equipment - General Industry):**
  - a. ESAMS Course #3639,**
  
- (4) Fall Protection Program Managers:**
  - Part 1: ESAMS Course # 4437 titled Fall Protection Program Management:**
  - Part 2: ESAMS Course # 4438 titled Fall Protection system and Equipment.**
  
- (5) Fall Protection Program Managers:**  
**NAVSAFENVTRACEN Course, CIN A-493-0099 (ESAMS Course ID 6360)**

**Web-Based Refresher/Update Fall Protection Training:**

- (5) Competent Person for Fall Protection: Receive ESAMS Course # 4438 again.**
- (6) End users: take ESAMS Course # 2018 again as refresher/update training. Hands-on training and practical demonstrations per ESAMS course #3024 may be delivered to the end user, per discretion of the Competent Person.**
- (7) Program manager: Take ESAMS Course # 4437 and 4438 again.**
- (8) Qualified Person for Fall Protection: Receive ESAMS Course # 4438.**

## **6.6 FALL PROTECTION TRAINING ROSTER**

- (1) All employees (workers) newly assigned to a job must review and understand the Fall Protection and Prevention Plan. If the Fall-Hazards, Fall Protection equipment, or methods change during the course of the job, the Fall Protection and Prevention Plan must be updated and reviewed again by all employees working at the job-site. Employees shall be trained in job hazard recognition and shall be trained in the proper use of Fall Protection equipment. Procedures may be developed at the local level to ensure compliance.
- (2) **All contractor and subcontractor workers exposed to Fall-Hazards shall be trained accordingly by non-Governmental trainers.**
- (3) If additional requirements arise or change at the job-site as work progresses, the Fall Protection and Prevention Plan and Rescue Plan shall be reviewed and updated by a qualified or Competent Person and signed by all workers exposed to Fall-Hazards.
- (4) For those employees visiting from another activity, to perform work at heights and exposed to Fall-Hazards at the Navy activity being visited and before starting work at that site, they shall be trained on the proper use of Fall Protection and rescue equipment.

**End of Section**

July 2017

## 6.7 FALL PROTECTION TRAINING ROSTER (FORM)

All personnel signing this form affirm that they understand the Fall-Hazards on the job-site, and that they have been trained in the proper use of, and will use, the selected Fall Protection equipment and methods. Review and sign again, if hazards or methods or work change.

NAME: \_\_\_\_\_  
ORGANIZATION/CODE/SHOP: \_\_\_\_\_  
TRAINING DATE(s): \_\_\_\_\_  
DURATION OF TRAINING (Hours): \_\_\_\_\_  
COURSE TITLE: \_\_\_\_\_  
DESCRIPTION OF THE COURSE: \_\_\_\_\_

NAME: \_\_\_\_\_  
ORGANIZATION/CODE/SHOP: \_\_\_\_\_  
TRAINING DATE(s): \_\_\_\_\_  
DURATION OF TRAINING (Hours): \_\_\_\_\_  
COURSE TITLE: \_\_\_\_\_  
DESCRIPTION OF THE COURSE: \_\_\_\_\_

NAME: \_\_\_\_\_  
ORGANIZATION/CODE/SHOP: \_\_\_\_\_  
TRAINING DATE(s): \_\_\_\_\_  
DURATION OF TRAINING (Hours): \_\_\_\_\_  
COURSE TITLE: \_\_\_\_\_  
DESCRIPTION OF THE COURSE: \_\_\_\_\_

NAME: \_\_\_\_\_  
ORGANIZATION/CODE/SHOP: \_\_\_\_\_  
TRAINING DATE(s): \_\_\_\_\_  
DURATION OF TRAINING (Hours): \_\_\_\_\_  
COURSE TITLE: \_\_\_\_\_  
DESCRIPTION OF THE COURSE: \_\_\_\_\_

INSTRUCTOR'S NAME: \_\_\_\_\_  
INSTRUCTURE'S SIGNATURE: \_\_\_\_\_

**End of Section**



## **7.0 FALL-HAZARD PREVENTION AND CONTROLS**

### **7.1 PREFERRED ORDER OF CONTROL MEASURES**

**The preferred order of control measures for Fall-Hazards is:**

- (1) **Elimination** – Removal of the hazard from a workplace. This is the most effective control measure (e.g., lowering various devices or instruments installed at high locations, such as meters or valves, to the height level of the individual; instead of servicing such devices or instruments at heights).
- (2) **Prevention** – (traditional) - The isolation or separation of the hazards from the general work areas (e.g., same level barriers such as guardrails, walls, covers or parapets.)
- (3) **Engineering Controls** – Where the hazard cannot be eliminated, isolated, or separated, engineering control is the next-preferred measure to controlling the risk (**e.g., design change or use of various equipment or techniques, such as aerial lift equipment or movable or stationary work platforms**).
- (4) **Administrative Controls** – This includes introducing new work practices that reduce the risk of a person's falling (e.g., erecting warning lines or designated areas, restricting access to certain areas, posting of warning signs or training).
- (5) **Personal Protective Systems and Equipment** – These shall be used after other control measures (such as eliminating or isolating Fall-Hazards) are determined not to be practical, or when secondary systems are needed (e.g., when it is necessary to increase protection by employing a backup system).

#### **NOTE:**

Control measures are not mutually exclusive. There may be situations wherein more than one control measure should be used to reduce the risk of a fall.

Navy or Marine Corps activities shall select Fall Protection measures compatible with the type of work being performed. If Fall-Hazards cannot be eliminated, Fall Protection can be provided through the use of Fall Protection systems and equipment and in accordance with chapters 8 or 9 of this guide.

## 7.2 FALL PROTECTION AND PREVENTION PLANS

The Fall Protection and Prevention Plans as required by OPNAVINST 5100.23 Series, MCO 5100.29 Series and NAVMC SIR 5100.8 are documents prepared by Navy or Marine Corps activities for the purpose of planning, designing, installing, monitoring, and rescuing workers exposed to Fall-Hazards; and to prevent fall accidents from occurring in the workplace. The Fall Protection and Prevention Plan is a living document that will require modification due to changes during different phases of work, procedures, methods of construction, or maintenance work. A Qualified or Competent Person for Fall Protection shall be responsible for preparing the Fall Protection and Prevention Plans, as well as making any required changes, designs, updates, or approvals relating to various methods and requirements pertaining to Fall Protection systems and equipment. If the plan includes Fall Protection components or systems requiring direction, supervision, design calculations or drawings by a Qualified Person for Fall Protection, the name, qualifications, and responsibilities of the Qualified Person shall be recorded in the plan. Paragraph 7.2.5 is a checklist that addresses the requirements for occasions where a Competent Person or a Qualified Person for Fall Protection is required to develop Fall Protection and prevention plan.

**A Fall Protection and Prevention Plan is equivalent to a permit to work at height;** therefore, it is of the utmost importance that a Fall Protection and Prevention Plan be prepared and approved prior to the start of work. The plan shall be kept at the work site at all times, with any changes noted. For those employees visiting from another activity, each of them shall obtain and sign a copy of the Fall Protection and Prevention Plan from the activity being visited. If no Fall Protection and Prevention Plan addressing Fall-Hazards exist at the worksite being visited, then the employee or other team leader in consultation with the CP shall prepare and sign an addendum to the Navy or Marine Corps activity Fall Protection and Prevention Plan of the employee's home activity, which addresses the use of Fall Protection and rescue equipment.

### Note:

**The American National Standards Institute, ANSI Z359.2 Standard, titled "Minimum Requirements for a Comprehensive Managed Fall Protection Program" identifies the Fall Protection and Prevention Plan as "Written Fall Protection Procedures". According to OPNAVINST 5100.23 Series, preparation of the Fall Protection and Prevention Plan is a requirement as part of the Fall Protection program.**

### 7.2.1 FALL PROTECTION AND PREVENTION PLAN REQUIREMENTS

The Fall Protection and Prevention Plan is different from the Fall Protection Plan required per 29 CFR 1926.502(k) and 29 CFR 1910.28 (b)(1)(C)(ii) Final Rule. A Fall Protection Plan as required by OSHA is only available to employees, performing construction work and when working on residential roofs (per the final rule, who can demonstrate that it is infeasible, or it

creates greater hazard, to use conventional Fall Protection systems: (i.e., guardrails, safety nets, or personal fall protection systems). The Fall Protection and Prevention Plan is a document that includes written procedures for performing a specific work, task, or project, indicating the proper way of using safe Fall Protection systems and equipment, and including any other relevant information; however, it is a requirement to develop a Fall Protection and prevention plan for routine and non-routine tasks. The site-specific and generic fall protection and prevention plan shall be prepared in advance.

For routine (frequent, lengthy and predictable) tasks a site-specific *“Fall Protection and Prevention Plan”* shall be prepared and used. For non-routine (infrequent and temporary and emergency) tasks, where fall-arrest/restraint or positioning system(s) are used, personnel may use a generic *“Fall Protection and Prevention Plan”*. The generic fall protection and prevention plan shall include additional information on how to proceed with work safely, when unidentified fall hazard is encountered and what is the procedure to make the generic plan site specific.

**The Fall Protection and Prevention Plan shall include the following:**

- a. Description of Fall-Hazards that will be encountered at the workplace by end users during performance of their work.
- b. Type of Fall Protection/fall prevention methods or systems used for every phase of work.
- c. Training requirements for every employee exposed to Fall-Hazards.
- d. Type of Fall Protection equipment and systems provided to the employees that might be exposed to Fall-Hazards.
- e. The names of qualified and Competent Persons included in the plan.
- f. The Fall Protection equipment and instructions for assembly, disassembly, storage maintenance, and care.
- g. A Fall Protection and Prevention Plan is prepared either by a Competent or Qualified Person for fall protection. A Competent Person will implement the plan. All employees working at heights and using personal fall protection equipment at a job-site shall understand and agree to comply with the requirements of the Fall Protection and Prevention Plan.
- h. The rescue plan and procedures shall be included as an enclosure to the fall protection and prevention plan.

**Note:**

**For sample written FP and Prevention Plan, see paragraph 7.2.3 or the checklist in paragraph 7.2.4.**

## **7.2.2 INSTRUCTIONS FOR PREPARING THE PLAN**

- a. The plan shall be prepared specifically for the workplace and the specific task (site specific).

July 2017

- b. The plan shall provide for 100% continuous Fall Protection.
- c. The plan shall include training requirements and qualifications of the end-user permitted to use the system.
- d. The plan shall also include the following:
  - Identification of acceptable and safe anchorages;
    - Certified Anchorages selected and designed by a Qualified Person for Fall Protection and/or Non-Certified Anchorages selected by a Competent Person for Fall Protection;
  - Complete setup procedure(s) for access;
  - Clearance requirements for free-fall distances and for total fall distances including available and required clearance;
  - Detailed instructions for assembling, use and dismantling of the system(s), including descriptions of all the components
  - Number of personnel using the system;
  - Any limitations of the system;
  - Applicable manufacturers' standards and drawings;
  - Detailed instructions for inspecting each component of the system, and intervals of inspection;
  - Any other pertinent information.

**End of Section**

July 2017

## 7.2.3 SAMPLE FALL PROTECTION AND PREVENTION PLAN (FORM)

Activity/Command: \_\_\_\_\_

Building/Facility # \_\_\_\_\_

Department: \_\_\_\_\_

Work Area/Location: \_\_\_\_\_

Plan Prepared by: \_\_\_\_\_

Date Prepared on: \_\_\_\_\_

Date Modified: \_\_\_\_\_

Plan implemented by: \_\_\_\_\_

Task/Work Description:

\_\_\_\_\_  
\_\_\_\_\_  
\_\_\_\_\_  
\_\_\_\_\_  
\_\_\_\_\_

Name of personnel exposed to Fall-Hazards: \_\_\_\_\_

Description of the Fall Protection system to be used: \_\_\_\_\_

Training Requirements: \_\_\_\_\_

Anchorage Location and type: \_\_\_\_\_

Anchorage Strength: \_\_\_\_\_

Certified/Non-Certified Anchorage(s): \_\_\_\_\_

Describe the rest of the system used: \_\_\_\_\_

Describe the set up procedure for access to work location:

\_\_\_\_\_

Instructions for:

Assembly: \_\_\_\_\_

Use: \_\_\_\_\_

Disassembly: \_\_\_\_\_

Inspection Care and Maintenance: \_\_\_\_\_

Available and required clearance: \_\_\_\_\_

Free-fall Distance: \_\_\_\_\_

Total Fall Distance: \_\_\_\_\_

Number of personnel using the system: \_\_\_\_\_

System Limitation: \_\_\_\_\_

Equipment Inspection Procedure and Intervals: \_\_\_\_\_

July 2017

**Design of the system (if required):**

---

---

**Manufacturer's standards/drawings including instructions and recommendations:**

---

**Any other info:** \_\_\_\_\_

**Include rescue plan and procedures:** \_\_\_\_\_

**Prepared by:** \_\_\_\_\_

**Approved by:** \_\_\_\_\_

**End of Section**

### 7.2.4 Site-specific Fall Protection and Prevention Plan Checklist

<i>GENERAL INFORMATION</i>			
<b>Activity/Command:</b>		<b>Date:</b>	
<b>Facility/Building #:</b>		<b>Phone:</b>	
<b>Detailed Location:</b>		<b>Plan Prepared By:</b>	
<b>Dates(s) Plan was Modified:</b>	1.	<b>This Revision of Plan Implemented on (Date):</b>	1.
	2.		2.
	3.		3.
<b>Task/Work Description:</b>			
<b>Name(s) of Personnel Exposed to Fall-Hazards and using Personal Fall Protection Equipment:</b>	1.	6.	
	2.	7.	
	3.	8.	
	4.	9.	
	5.	10.	
<i>Personal Fall Protection System</i>			
<b>Description of the Fall Protection System to Be Used:</b>		<b>Identification or Selection of Anchorage(s) and Types:</b>	
<b>Anchorage Location:</b>		<b>Anchorage Strength:</b>	
<b>Certified Anchorages designed by QP</b>		<b>Required Strength</b>	
<b>Free-fall distance</b>		<b>Total fall Distance</b>	
<b>Required Clearance</b>		<b>Available and required Clearance</b>	
<b>Design of FA System (If required)</b>		<b>Personal Fall Protection System Limitations</b>	
<i>TRAINING</i>			
<b>Competent Person and/or Qualified Person training Completed:</b>		<b>End-user(s) Training Completed:</b>	
<b>Program Manager Training Completed</b>			
<i>OTHER INFORMATION</i>			
<b>Include Manufacturer's Instructions and Recommendations for Use, Assembly, Disassembly and Inspection Criteria</b>			
<b>Additional Instructions:</b>			



## 7.2.5 WHEN A COMPETENT OR QUALIFIED PERSON IS REQUIRED TO DEVELOP FALL PROTECTION AND PREVENTION PLAN

<b>COMPETENT OR QUALIFIED PERSON CHECKLIST</b>			
<b>Navy or Marine Corps Command:</b>	<b>Location</b>		
<b>FP Program Manager:</b>	<b>Date:</b>		
<b>COMPETENT PERSON INFORMATION</b>			
<b>Competent Persons Name:</b> _____ <b>Length of experience in this occupation:</b> _____			
<b>TRAINING KNOWLEDGE AND EXPERIENCE</b>			
	<b>Yes</b>	<b>No</b>	<b>N/A</b>
<b>Does the designated individual have training knowledge and experience in:</b>			
• <b>Applicable Fall Protection regulations, standards and requirements?</b>			
• <b>Fall-Hazard recognition (How to recognize and identify Fall-Hazards)?</b>			
• <b>Duties and responsibilities of other designated personnel under the FP Program (e.g. Qualified Person, end-user, authorized rescuer, etc.)?</b>			
• <b>Conducting Fall-Hazard surveys and preparing survey report?</b>			
• <b>The requirements and criteria for guardrails, safety nets, scaffolds, aerial lifts and movable and stationary work platforms, warning line system/designated area, and safety monitoring system?</b>			

<ul style="list-style-type: none"> <li>• <b>Developing Fall Protection and prevention plans (written Fall Protection procedures)?</b></li> </ul> <p style="text-align: center;"><b>Notes:</b></p> <ol style="list-style-type: none"> <li>1. <b>If the Fall Protection and Prevention plan includes Fall Protection components or systems requiring direction, supervision, design calculations or drawings by a Qualified Person for Fall Protection or a professional engineer, the name, qualifications, responsibilities, training knowledge, experience and signature of the Qualified Person for Fall Protection or professional engineer shall also be addressed in the plan.</b></li> <li>2. <b>At a minimum, the Qualified Person/professional engineer information is required when using Horizontal Lifelines, Other Engineered Systems, the anchorages or tie-off points are located below the dorsal D–ring and designing certified anchorages that require being twice the maximum arrest or potential force.</b></li> </ol>			
<ul style="list-style-type: none"> <li>• <b>Fall-arrest, positioning, restraint and climbing ladder fall arrest systems</b></li> </ul>			
<ul style="list-style-type: none"> <li>• <b>Fall-Hazard elimination and control methods including hands-on how to assemble, disassemble and use Fall Protection systems and equipment (Donning of the equipment, equipment installation techniques and proper anchoring and tie-off techniques)?</b></li> </ul>			
<ul style="list-style-type: none"> <li>• <b>Fall Protection system and equipment assessments (e.g. component compatibility, estimating free-fall distances, total fall distance and available and required clearance, and common hazards of each system and component used) and determining when a system is unsafe?</b></li> </ul>			
<ul style="list-style-type: none"> <li>• <b>How to conduct detailed inspection storage care and maintenance of equipment, components and systems with documentation?</b></li> </ul>			
<ul style="list-style-type: none"> <li>• <b>Fall Protection rescue equipment and procedures and prepare Fall-Hazard rescue plan?</b></li> </ul>			
<ul style="list-style-type: none"> <li>• <b>The selection and use of non-certified anchorages (e.g. 5,000 lbs. anchorage for FA)?</b></li> </ul>			
<ul style="list-style-type: none"> <li>• <b>Requirements for working over or near water or working from/in machinery over water</b></li> </ul>			

July 2017

<p><b>List training/experience including certificate of training:</b></p>			
<p><b>AUTHORITY</b></p>	<p><b>Yes</b></p>	<p><b>No</b></p>	<p><b>N/A</b></p>
<p><b>Does the designated individual have authority from the Command to:</b></p> <ul style="list-style-type: none"> <li>• <b>Take prompt corrective action to eliminate existing and predictable fall hazards?</b></li> <li>• <b>Stop work?</b></li> </ul>			

Use of this checklist is optional.

**End of Section**

## **8.0 FALL PROTECTION SYSTEMS, CRITERIA, AND DESIGN REQUIREMENTS**

### **System Selection**

It is very important for a Qualified or Competent Person for Fall Protection to plan, evaluate, and select the most appropriate, safe, and efficient Fall Protection system. There are many Fall Protection systems available which can be used. It is of the utmost importance to select the right system for a specific work application. A complete understanding of work procedures will enable the Qualified Person for Fall Protection or Competent Person for Fall Protection to select the most appropriate Fall Protection system.

### **Redundant (Secondary) System**

In every fall-hazard situation, it is always advisable to have two protective systems, primary, and a secondary system as back-up. If the primary system fails, the secondary system shall protect the employee from falling. For example, when approaching an unprotected side or edge of a roof, the employee's primary protective system is his/her feet. A secondary protective system is required as backup, such as a fall-arrest/restraint system, or guardrails. When climbing a fixed ladder or a pole, the employee's primary fall protective system is his/her hands and feet. A climbing ladder FA system or a self-retracting lanyard is required as a secondary backup system. Always plan to have two Fall Protection systems; primary, and secondary.

## **8.1 FALL PROTECTION SYSTEMS**

Every employee on a walking working surface, exposed to a Fall-Hazard shall be protected from falling to a lower level by the use of a Fall Protection system. The common Fall Protection systems are:

### **Prevention Systems (Passive Fall protection Systems)**

- **Guardrail Systems**
- **Covers**
- **Safety Nets**

### **Active Fall Protection Systems**

- **Fall-Arrest System**
- **Flexible Horizontal Lifeline System**

July 2017

- **Rigid Horizontal Rail System**
- **Single Anchor Vertical Lifeline**
- **Climbing Ladder Fall Arrest System (Ladder Safety System)**
- **Restraint System**

#### **Other Fall Protection Systems**

- **Positioning System**
- **Warning Line System**
- **Designated Area**

#### **Other Engineered Fall Protection System**

#### **Suspended Rope Access**

#### **Ladder Cages**

#### **Prohibited Fall Protection Systems**

- **Safety Monitoring System**
- **Controlled Access Zone**

## **8.2 FALL PROTECTION SYSTEMS CRITERIA & REQUIREMENTS**

### **8.2.1 PREVENTION SYSTEMS (Passive Fall Protection Systems)**

#### **8.2.1.1 GUARDRAIL SYSTEM**

Guardrail System is a conventional method for the prevention of falls from heights which is installed at all open sided floors, openings and platforms where a person is required to walk or work. Guardrails can be temporary or permanent.

**Open sided floor or edge** mean any side or edge (except at entrances to points of access of floors, roofs, working platforms, stairs, catwalks, scaffolds, and ramps or runways) where there is no wall or guardrail system.

**Guardrail consists of top-rail, mid-rail, posts (stanchions) and toe-board.**

#### **Note 1:**

Requirements for permanent guardrail systems installed in buildings are prescribed in the International Building Code (IBC)

July 2017

using the term “Guards” instead of guardrails. Permanent Guard requirements for height and strength are identical to guardrails prescribed by OSHA.

**Note 2:**

Guardrails shall be so surfaced as to prevent injury from punctures or lacerations, and to prevent snagging of clothing.

**(a) Criteria:**

- **Top-rail** shall be 42 inches high, plus or minus 3 inches above walking/working level or surface. (39-45 inches high).
- **Mid-rail** shall be located half way between the top edge of the guardrail system and the walking working surface, but never more than a 19 inch gap between the mid-rail shall be installed between the top rail and the walking working surface.
  - Screens, mesh, intermediate vertical members or equivalent intermediate structural members can replace the mid-rail. The vertical opening shall not be greater than 19 inches.
- **Supporting Posts** shall be installed at whatever distance is necessary to meet the top rail strength requirement of 200 lbs. without failure. **The verbiage “Posts shall be spaced no more than 8 feet apart on centers” was deleted (Final Rule).**
- **Toeboard** shall be minimum 3½ inches high, per 29 CFR 1926 Subpart M. According to 29 CFR 1910, the required toe-board height is 3 1/2 inches (nominal height of 4 inches).

**Note:**

Permanent guardrails shall be designed according to the International Building Code. The OSHA 42 inches +/- 3 inches top rail height criteria is only for compliance purpose. The IBC requires the height of the top rail to be 42 inches (explicit number) without the +/- 3 inches range. However, the height can be increased if there are other factors that will require permanent guardrails to be between the ranges of 39-45 inches or even higher (i.e. using a step ladder to replace a light bulb near the guardrail).

**(b) Minimum Material of Construction.****(1) Wood Construction:**

Wood components shall be of construction grade lumber or better (minimum 1,500 lbs.-ft./square inch fiber stress);

Top rail and Posts shall be minimum nominal 2X4 lumber;  
Mid rail shall be made a minimum nominal 1X6 lumber;  
Toe-board shall be made a minimum nominal 1X4 lumber.



**Temporary Guardrail**

**(2) Structural Steel:**

Posts, top-rail and mid-rail shall be at least 2-inches X 2-inches X 3/8 inch structural steel angles.

**(3) Pipe Railing**

Posts, top rail and mid rail shall be at least 1-1/2 inches nominal diameter (schedule 40 pipe).



**Removable Railing**



**Collapsible Railing**

**Temporary Pipe Railing Systems**



July 2017

**Note**

The above removable railing is called counterbalanced guardrails or movable weighted-base railing. Although temporary in nature, the required strength for guardrails may not be attained. There are no standards for this solution yet.

However, there are removable sectional guardrails (non-penetrating) that can be connected together to make the system non removable (permanent) that requires the use of tools to attach all sections together and will be safer with regard to the impact of wind stresses on the system (see below). The designer has to research for this type of solution to make the system permanent.

**Permanent Pipe Railings****(4) Steel Cable**

Top-rail and mid-rail shall be at least  $\frac{1}{4}$  inch steel cable flagged every 6 feet with high visibility material. There shall not be more than a 3 inches sag in the steel cable.

**Steel Cable Guardrail**

## (5) Chains

Steel chains for top-rail and mid-rail, all components shall have the same criteria for guardrail system above. There shall not be more than a 3 inches of sag in the chain.

### Note:

Guardrails or stair-rails shall be so surfaced as to prevent injury from punctures or lacerations, and to prevent snagging of clothing.

## (c) Guardrail Strength Requirements.

The following are the *minimum* forces the temporary guardrail system members shall withstand without failure when applied within 2 inches from the top edge in any outward or downward direction:

Top-rails -----	200 pounds
Mid-rail -----	150 pounds
Toe-board -----	50 pounds

Any screen, mesh. Intermediate vertical member, solid panel and any equivalent structural member shall withstand a force of 150 pounds.

When a 200-pound force is applied at the top edge of the top-rail in a downward direction, it shall not deflect more than 3 inches.

## (d) Requirements for Guardrails at Hoisting Areas

During hoisting operations If a segment or side of the railing system is required to be left open for easy access at an unprotected side, edge, hatch, etc., **use self-closing swing gates**, chain, removable guardrail section or fall arrest/restraint system will be required to protect personnel from falling. When guardrails are used at hoisting areas, a minimum 6 feet of guardrail shall be erected on each side of the access point through which materials are hoisted.



**Removable Guardrail at  
second Floor**



**Loading Platform w/Removable  
Chain at point of access, however  
Mid Rail is also Required**

### **Railing at Hoisting Areas**

#### **(e) Stair-Rails and Handrails:**

- **Stair-Rails**
- **Permanent stair-rails shall be 42 inches high (per International Building Code and OSHA final rule).**
- Temporary stair rails shall be 36 inches high (per 29 CFR 1926).
- Stair-rails per 29 CFR 1910 (1970) shall be 30-34 inches high.
- **Hand-Rails**
- **Permanent handrails shall be mounted 34 to 38 inches high to the top of the rail (Per International Building Code).**
- Temporary hand-rails per 29 CFR 1926 shall be 30-37 inches high.
- Hand-rails per 29 CFR 1910 final rule shall be 30-38 inches high.

- **Permanent Stair Rail: 42 inches high**
- **Permanent Hand Rail: 34-38 inches high**

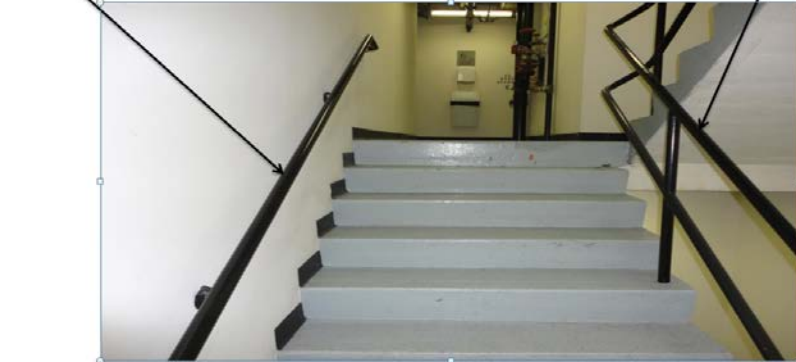

Industrial Stairs

### 8.2.1.2 PARAPETS

In order for the height of parapet wall to be in compliance with 29 CFR 1910 (Final Rule) it shall be 42 +/- 3 inches high.

According to IBC, parapets are usually designed for 30 inches high. The height of the existing parapets shall not be increased to comply with the guardrail height requirement of 42 inches  $\pm$  3 inches, without involving a structural engineer. Increasing the height of the parapet to 42 inches increases the exposure to wind stresses. Since the parapet resists wind by acting as a cantilever, the stresses at the base of the parapet (The level of the roof structure) is proportional to the square of the parapet height. For example, adding an extra foot to the existing 2 foot high parapet wall roughly doubles the wind stresses at the base. Recommend using either steel cable or railing to make the parapet 42 inches high ( $\pm$  3 inches).



## Solutions using additional railing to make parapets comply with OSHA 42 inch height Requirement

Before the Final Rule was published, OSHA permitted the existing parapet walls with heights less than 42 inches, the parapet wall may be used as a Fall Protection system if the vertical height is a **minimum of 30 inches** and the width a minimum of 18 inches at the top of the wall for a total of 48 inches combined. The effective height of a parapet wall is the sum of the height of the wall plus the wall width at the top of the wall. Per the Final Rule, the sum of 30 inches minimum height and 18 inches wide parapet walls equal to 48 inches is prohibited by OSHA. The parapet walls shall be designed to a height of 42 inches ( $\pm 3$  inches), to be considered adequate Fall Protection systems.

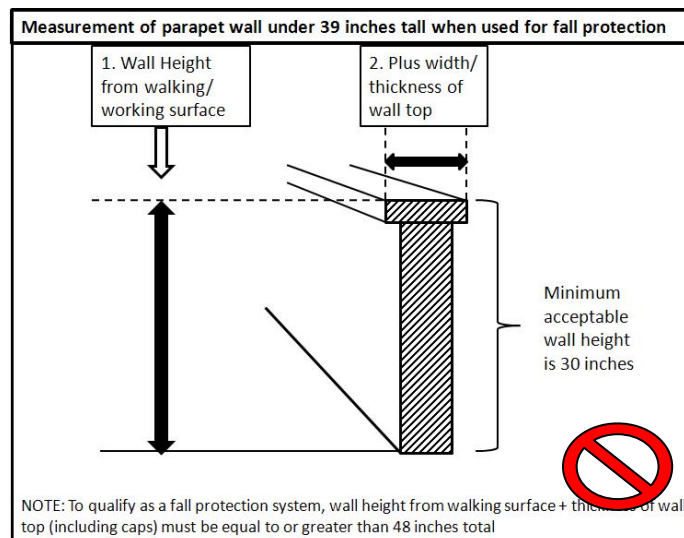

### 8.2.1.3 COVERS

According to 29 CFR 1910, final rule and 1926.500, a hole means a gap or open space in a floor, roof, horizontal walking working surface, or similar surface that is at least 2 inches in its least dimension, through which material or tools can fall through; or, in the case of larger holes, a person can step or fall through. In either case, FP in the form of a secured and marked covering or barricade is required. Examples include manholes, pits, tanks, skylights, open shafts, chutes, and hatches. Consideration also should be given to guarding holes which may present a trip or entrapment hazard.

#### (a) REQUIREMENTS FOR COVERS

Install a cover on any hole, 2 inches or more in its least dimension.

All covers shall be capable of supporting, without failure, at least twice the weight of the employees, equipment and materials that may be imposed on the cover at any time.

Covers shall be secured in place when installed.



If scissor/aerial lifts are on the same level, the potential for them to run over the hole-cover is high. This must be considered in the cover design



OSHA Compliant Cover

### (b) Skylights

- Skylight openings must also be covered. Most of older skylights will not support the weight of the worker.
- If there should be a danger of falling through a skylight opening, a standard screen/mesh cover or temporary or permanent guardrail system must be installed on all sides of the skylight.



### Skylight Solutions

- Trenches, utility covers, and other similar features — when located in a roadway or vehicular aisle — shall be designed to carry twice the maximum axle load of the largest vehicle expected to cross over.

### (c) Hatches

- Hatches shall always be protected when opened.
- If ladder is used to access thru a hatch, it shall extend 3 – 3 ½ feet above the walking working surface.
- Hatch opening shall be provided with a mean to facilitate access and exit from a fixed ladder (i.e. Grab Bars 42 inches high or other such items that can be grasped by the climber).If ladder is used to access thru a hatch, it shall extend 3–3 ½ ft. above the walking working surface.
- According to the Final Rule, when guardrail system is used around holes:
  - The ladder way or platform hole shall be protected by the use of guardrail system and toeboards erected on all exposed sides, except the entrance to the hole where a self-closing gate or an offset shall be used
  - The hole shall be protected on 2 sides when material is being passed.
  - Hole shall be protected on 4 sides when materials are not being passed.



### Hatch Cover Solutions

- When guardrails are used around holes that serve a point of access the opening shall have a swinging gate or offset to prevent an employee from walking or falling into the hole.



### 8.2.1.4 SAFETY NETS

Safety nets are considered passive fall protection systems. They are installed as close as practicable below the leading edge for employee protection or when working over water, on bridges, or high-rise buildings or structures.

- (1) The minimum breaking strength of border rope or webbing shall be 5,000 pounds.
- (2) The mesh opening shall not be larger than 36 square inches or longer than 6 inches on any side.
- (3) In any case, the net shall be installed not lower than 25 feet from the working surface.
- (4) Safety nets shall extend out from the working surface as follows:

Distance from working <u>level to the</u> <u>net</u>	Distance the net shall <u>extend</u> <u>from working surface</u>
<b>Up to 5 feet</b>	<b>8 feet</b>
<b>Over 5 feet up to 10 feet</b>	<b>10 feet</b>
<b>Over 10 feet</b>	<b>13 feet</b>

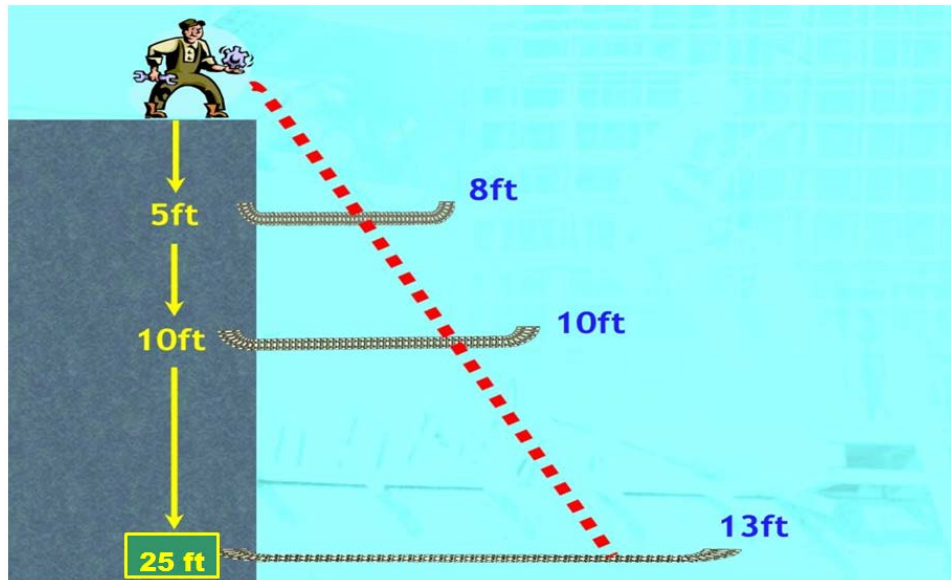

**Safety Net Extensions**

July 2017

(5) Safety nets shall be tested in suspension position in the field and certified by a Qualified Person immediately after installation and at six month intervals using a drop test of 400 pounds, dropped from the same elevation a worker might fall. When dropping the 400 lbs. weight into the net it is difficult to retrieve it, the best thing to do, tare the bag of sand and let the sand drop to lower level.

(6) Inspect safety nets immediately after installation, weekly thereafter, and following any alteration or repairs. Inspection must be documented.

(7) Shackles and hooks used for safety net installations shall be made of forged steel.

(8) Immediately remove any debris that falls into the net.

## 8.2.2 ACTIVE FP SYSTEMS

### 8.2.2.1 FALL ARREST SYSTEM

Fall arrest system is an assembly of components and subsystems used to arrest a fall. Fall-arrest System consists of the following subsystems and components:

- **Anchorage System** – Consists of anchorage and anchorage connector.
- **Connecting Means** – Includes energy absorbing lanyard with snaphook or carabiner at each end or self-retracting device. The subsystem may also include fall-arrester.
- **Body Support** – Consists of full-body harness with integral dorsal D-ring.
- **Rescue procedures** – Consist of self-rescue or assisted rescue.

**Note:**

**Fall-arrest is considered an active Fall Protection system. The system will become activated when a fall is initiated. Fall-arrest system is also considered a secondary or backup system.**

**Note:**

**Whenever possible, employees should work in pairs (buddy system). At the minimum, there must be an assigned safety person (spotter) when there is an employee or employees climbing and performing work at heights and using fall-arrest equipment.**

**WARNING**

July 2017

**Personal fall protection systems (PFPS) are typically certified and labeled only within the capacity range of 130 to 310 pounds (59 to 140.6 kg) including the weight of the worker, equipment, clothing and tools. Workers shall not be permitted to exceed the 310-pound weight limit, unless the harness and the lanyard are permitted for use in writing by the manufacturer. The concern for end users with body weight more than 310 pounds is the potential to fully deploy the energy absorber and the exposure to arrest forces greater than 1,800 pounds prescribed by OSHA and ANSI Z359 Standards.**

**WARNING**

**For workers with body weight less than 130 pounds, a specially designed harness and a specially designed energy absorbing lanyard which will properly deploy if this person were to fall, shall be utilized. The concern for end users with body weight less than 130 pounds is the arrest force (G force) that they may experience.**

**It is very important that health consideration be taken into account for workers weighing more than 310 pounds. Therefore, it is highly recommended for overweight workers, weighing over 310 pounds, to consult a physician prior to use of the equipment to determine that he or she has no medical conditions (e.g., hypertension, diabetes, coronary heart condition, etc.). Heavy workers are usually in a high-risk category for health and occupational injuries. While personal protective equipment may have the strength to stop the worker from contacting a lower level or object during a fall, typically the fall forces imposed on the body of heavy workers will be higher than those of the average-weight worker; requiring the need to review and evaluate the fall-arrest system used, as well as the worker's medical condition(s). The following are some questions for consideration by the Qualified Person or the Competent Person for Fall Protection before selection and use of the equipment by overweight workers:**

- **Can the structure or the anchorage support the potential fall forces?**
- **Can the free-fall distance be minimized during a fall? (The ability to adjust the energy absorbing lanyard's length or raising the anchorage location will minimize the free-fall distance.)**
- **Is the lanyard or lifeline rated for higher capacity?**
- **Is the full-body harness rated for higher capacity?**

- **Is the rescue plan and procedures adequate to accommodate heavy-weight workers? The rescue equipment for heavy workers may need to be more robust, or other methods for rescue may need to be planned.**



### 8.2.2.2 FALL-ARREST SYSTEM REQUIREMENTS

Elements of a Personal Fall Arrest System (PFAS) consist of an anchorage system which includes the anchorage (rigid part of the structure) and anchorage connector, connecting means which may include energy absorbing lanyard, self-retracting device, fall arrestor or lifeline, and a full body harness or suitable combinations. The PFAS must be capable of arresting a free fall safely, suspend the victim vertically while awaiting rescue, and allow rescue personnel to accomplish identified tasks in a fall hazard situation. All components and subcomponents of a PFAS must be compatible.

#### OSHA Requirements

- (1) The system shall limit the maximum arrest force on the worker's body to 1,800 pounds, when wearing a full-body harness.
- (2) Maximum free-fall distance shall not to exceed 6 feet.
- (3) The system shall stop the fall within a deceleration distance of not more than 42 inches.
- (4) The system shall prevent the worker from contacting a lower level or object.

**Note 1**

**OSHA Standards and the New ANSI Z359 FP Code/Standards permit the free-fall distance to exceed 6 feet and up to 12 feet, provided the maximum arrest force on the body does not exceed 1,800 pounds and the proper energy absorbing lanyard is used. Only the Qualified Person for Fall Protection can make this determination (increasing the free-fall distances to more than 6 feet and using 12 foot free-fall energy absorbing lanyard, when tied at the foot level).**

**8.2.2.3 FALL-ARREST SUBSYSTEM AND COMPONENTS**

**All personal fall-arrest equipment used shall meet the requirements of ANSI Z359 Fall Protection Code/Standards. Any equipment meeting ANSI A10.14 or ANSI Z359.1 (1992 Revised 1999) shall not be used and shall be removed from service.**

**(a) Anchorage System for Fall-arrest:**

Anchorage system consists of anchorage and anchorage connector:

- **Anchorage** is the rigid part of a building or structure such as a beam, column, floor or equipment and shall withstand a minimum force (breaking strength) of 5,000 pounds, or engineered for twice the maximum arresting force by the Qualified Person for Fall Protection (a secure point for attaching fall arrest system). The 5,000 lbs. anchorage or 2 times the arrest force means the required anchorage for active FP system, not the structure. Anchorages used for personal fall arrest shall be independent of any anchorage used to support or suspend platforms or loads.
- **Anchorage Connector** is the terminus component of the active fall protection system, intended for attaching personal fall-arrest system to the anchorage. Anchorage connectors shall meet the requirements of the anchorage and shall withstand a force of 5,000 pounds. A wide variety of anchorage connectors are available for use as part of a PFAS. Examples of anchorage connectors include but not limited to tie-off adaptor, beam clamps, roof anchors, self-locking eye connectors and ballasted anchors (Free Standing).

**Note:**

Always consider the compatibility between the anchorage and anchorage connector to prevent unintentional disengagement.

- (1) Tie-off Adapter.** The tie-off adapter is a common component of a PFAS. The tie-off adapter is, in essence, two “D” rings connected together by synthetic webbing or wire rope, typically with built-in chaffing protection. The tie-off adapter allows personnel to improvise an anchorage by wrapping the adapter around a structural member of suitable strength. A lanyard or other components of the PFAS can then be attached to the tie-off adapter. Tie-off adapters can be found in three-, four-, and six-foot lengths. Additional lengths can be purchased.

When selecting a tie-off adaptor as part of a PFAS, consideration must be given to potential misuse and inappropriate use. Anchorages have failed when the tie-off adapters were not attached to sufficiently strong structural members.

**(2) Other Examples of Anchorage Connectors**



**Tie-Off Adaptor**



**Anchor Post**



**Force Management Anchor Post**



**Beam Anchor**



**Permanent Anchor**



**Stanchion used for Steel Erection**





**Roof anchor**



**Swivel Roof Anchor**

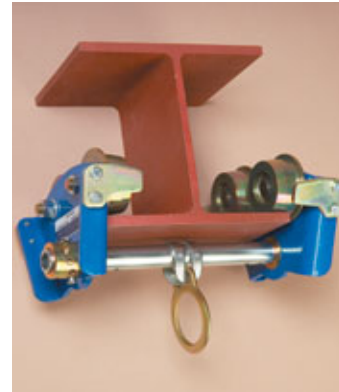

**Beam Clamp**



**Anchorage connectors anchored into Concrete**



**Ballasted Anchor**



**Anchorage connector for wood construction that spreads the fall forces on more than one rafter**

**Free standing Tripod used for confined space entry and retrieval**



**D-ring Anchor**



**Anchor Post**



**Beam Anchor**



July 2017

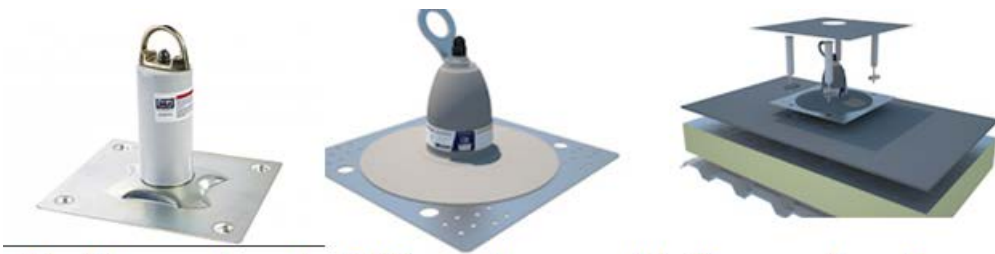

**Roof top anchors for PVC membrane and built-up roofs, with weather proofing shroud**



**Permanent anchor for wood**



**Free Standing or Ballasted Anchor**



**Concrete Anchor**



**Tie Back Anchor**

### (3) Eye Bolts

- A large eye-bolt made of the appropriate grade steel (forged steel) may serve as an acceptable anchorage connector
- The strength of an eye-bolt is rated along the axis of the bolt
- The strength of the eyebolt is greatly reduced if the force is applied at an angle less than 45 degrees to this axis

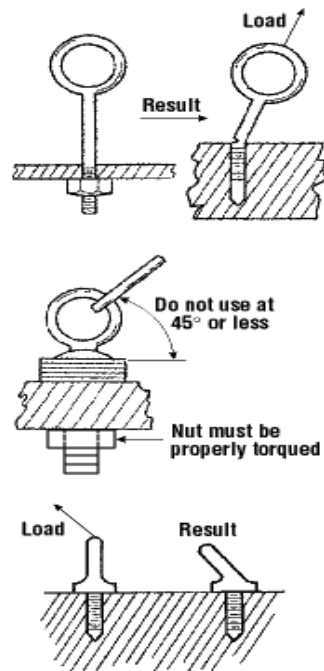

### (4) Wire Form anchors

- Wire form anchors are frequently used in tower construction.

July 2017



- Do not apply a side load to the anchorage connector (use in vertical application)

## (b.2) Connecting Means

Method or subsystem used to connect body support to the anchorage

Subsystem may include:

- Energy absorbing (shock absorbing) lanyard made of strap, webbing or rope
- Self-Retracting Devices
- Fall Arrestor (is a rope grab or cable grab) connected to a lifeline or rope lanyard

### (a) Energy Absorbing Lanyard:

**Energy Absorbing (EA) Lanyard.** The EA lanyard as part of a PFAS connects the full body harness to an anchorage and reduces the forces of a fall through an integral shock absorber (deceleration device). Lanyards are available in three, four, or six-foot lengths depending on the application, although longer lanyards are available (use-only in restraint systems). Lanyards must have snap hooks or carabiners and be designed for a PFAS. Commercial variations include adjustable EA lanyards that allow the lanyard to be shortened, reducing potential free fall distance. Variations also include EA lanyards with built-in chaffing protection and may include a “D” ring connector that allows a lanyard to be used to wrap around an anchorage. Double “Y” lanyards allow for 100% tie-off (i.e., one lanyard can always be connected to an anchorage). There are two types of energy absorbing single and “Y” lanyards. The first type is the six foot free fall energy absorbing (single and “Y” lanyards) is only used when the anchorage point is located above the Dorsal D-ring. The second type is the 12 foot free fall single and “Y” lanyards used when the tie off point is below the dorsal D-ring.

When selecting a lanyard, consideration must be given to the availability and location of the anchorage point, free fall and total fall distance, potential chaffing and weight of the person, and capacity of the equipment. All newly purchased EA lanyards must be equipped with deployment indicators and at least one Lanyard Parking Location. Personal energy absorbers must be designed such that it is obvious if they have been activated or by a warning or flag or label that indicates activation. Lanyards used in restraint systems and positioning lanyards can be either fixed or adjustable.

**Requirements:**

- (1) **The length of the lanyard used in fall-arrest shall not exceed 6 feet.**
- (2) The strength of the lanyard and the energy absorber shall be 5,000 pounds, minimum.
- (3) The minimum diameter of a synthetic rope lanyard is 1/2 inch.
- (4) Provide energy absorbers (shock absorbers) with lanyards (integral in-line is preferred).
- (5) Commercial variations include adjustable EA lanyards that allow the lanyard to be shortened, reducing potential free fall distance. Variations also include EA lanyards with built-in chaffing protection and may include a “D” ring connector that allows a lanyard to be used to wrap around an anchorage
- (6) The requirements for energy absorbers and energy absorbing lanyards prescribed in ANSI Z359.13 Standard supersede the corresponding requirements prescribed in ANSI Z359.1 (2007).**
- (7) There are two types of single and “Y” energy absorbing lanyards:

**(i) Six foot Free-fall Energy Absorbing Lanyard:**

The 6-foot Free-fall (FF) energy absorbing lanyard shall be used only when the tie-off point is located above the dorsal D-ring, creating a FF distance of less than 6 feet. The average arresting force on the body shall be no greater than 900 lbs. (4 kN) under ambient dry conditions, and 1,125 pounds under ambient wet conditions without exceeding the maximum arrest force of 1,800 pounds (8 kN). The maximum deployment distance of the energy absorber shall be 4 feet, which is greater than the OSHA requirement of 3½ feet.



**Six foot free fall energy absorbing lanyard**



**Do not tie the lanyard back to itself. A knot reduces the strength of the lanyard by 50-70%**

**(ii) 12-foot Free-Fall Energy Absorbing Lanyard:**

When an anchor point is below the dorsal D-ring, a free-fall (FF) distance greater than 6 feet is created. For these situations, a 12-foot FF energy- absorbing lanyard shall be used in accordance with manufacturer's instructions and recommendations. The average arresting force on the body shall be no greater than 1,350 pounds (6 kN) under ambient dry conditions, and 1,575 pounds under wet conditions without exceeding the maximum arrest force of 1,800 pounds. The maximum deployment distance of the energy absorber shall be 5 feet. The 12-foot FF energy absorbing lanyard shall be used when the tie-off point is located below the dorsal D-ring.

July 2017

**Note (1):**

**A 12-foot FF energy-absorbing lanyard does not refer to the lanyard length. Instead it refers to a free-fall distance that is greater than 6 feet (up to 12 feet), which is created by the anchor point’s being located below the dorsal D-ring (at the foot level). The maximum lanyard length shall not exceed 6 feet. (Personnel whose body weight and equipment exceed 310 lbs. shall not be permitted to use the 12-foot FF energy absorbing lanyard; always refer to equipment labels and manufacturer’s instructions, restrictions and recommendations).**

**Note (2):**

**The deployment distance of the 6-foot FF and 12-foot FF energy absorbers is very critical when calculating the required clearance for the fall-arrest system.**

(8) When using the 6-foot or 12-foot FF Energy Absorbing “Y” lanyards. The joint between the two legs shall be designed for 5,000 pounds. It is highly recommended to use a “Y” lanyard having legs that expand and contract (Retractable).

(9) A lanyard strap shall not be wrapped around a tie-off point and then attached back to it-self; unless it is a tieback lanyard where the lanyard strap has been designed accordingly.

(10) The snaphook shall only be attached to an integral D-ring (incorporated into the full body harness by the manufacturer).

(11) All energy absorbers shall have permanently attached labels indicating the manufacturer’s name, serial number or lot number, date of manufacture, capacity, and that applicable OSHA and ANSI Z359 Fall Protection Code/Standards have been met. The label of 6 ft. FF EA lanyard shall have white background with black lettering and the 12 ft. FF EA lanyard shall have black background with white lettering.

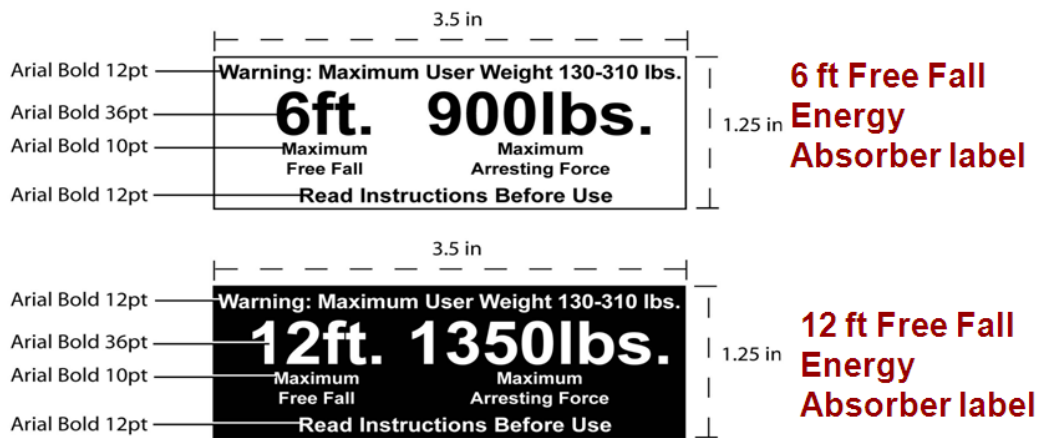

Energy Absorbing Lanyard Labels



- (12) It shall be recognized that synthetic rope and nylon strap lanyards are more elastic than Kevlar or wire rope lanyards.
- (13) The 12 ft. FF energy absorbing lanyard may also be used when the FF distance is less than 6 feet (When the anchorage is located above the dorsal D-ring).
- (14) The activation force required to deploy the energy absorber shall be less than 450 pounds.

**Note:**

**All newly purchased single and “Y” energy absorbing lanyards shall be equipped with at least one Deployment Indicator and at least one Lanyard Parking Attachment Element. Personal EA must be designed such that it is obvious if they have been activated or by a warning or flag or label that indicates activation.**



**“Y” Lanyards**

### **Warnings when using “Y” Lanyards**

- Do not attach the unused leg of the “Y” lanyard to any part of the harness except to attachment points specifically designated by the manufacturer; especially the “Y” lanyard having a single common energy absorber.



Lanyard Parking  
Attachment  
Element

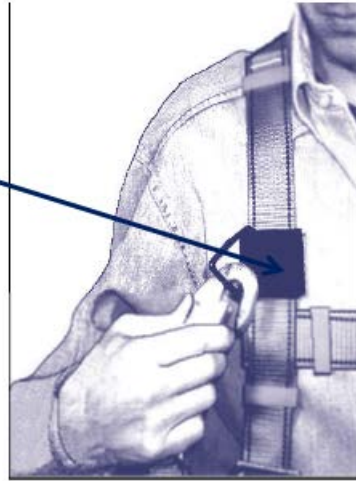

- Do not allow the legs of the lanyard to pass under arms, between the legs, or around the neck of the end-user.
- Do not connect the energy absorber of the “Y” lanyard to the anchorage; connect only to the dorsal D-ring.
- Do not use a 6-foot FF energy-absorbing “Y” lanyard if the free-fall (FF) distance is greater than 6 feet.
- When traversing, do not connect to anchorages that are farther apart than the lanyard length,

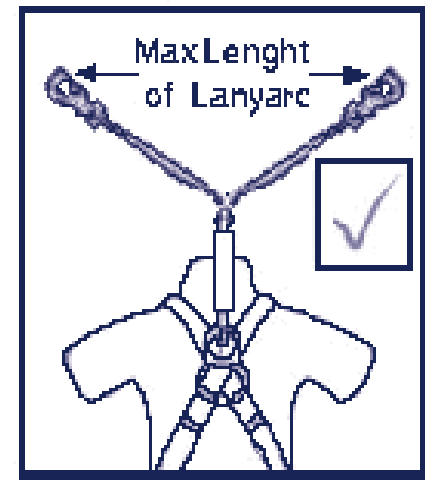

**(b) Snaphooks and Carabiners:**

- (1) Shall have a minimum strength of 5,000 pounds.

July 2017

(2) The gate must withstand a minimum force of 3,600 pounds when applied in any direction, and shall meet the requirement of ANSI Z359.12 standard. Few snap-hooks or carabiners have gate strength of 5,000 pounds (end-users shall be trained to recognize this type of equipment).

(3) The requirements for snaphooks and carabiners prescribed in ANSI Z359.12 supersede the corresponding requirements prescribed in ANSI Z359.1 (2007)

**Snaphooks and carabiners having side loading gate strength of 350 pounds, (Manufactured per ANSI Z359.1 (1992, R1999)) shall not be used.**

(3) Snaphooks and carabiners shall be sized to be compatible with the connectors to which they are connected to. Compatible connections will prevent unintentional disengagement.

(4) Snaphooks and carabiners shall be self-closing and self-locking, capable of being opened by at least two consecutive deliberate actions. The non-locking types are prohibited.

**Compliant snaphooks and carabiners shall be engraved with the words “3,600 pounds”, denoting the gate strength.**



**Locking Snaphooks**



**Carabiner**



**Correct Connection**



**Wrong Connection**



**Wrong Connection**

### **(b.1) Hardware Compatibility**

- Hardware compatibility is the relationship between components (i.e. snaphook and D-ring). The snaphook shall be sized so that the gate is protected and should not be opened by the D-ring itself.
- Using locking snaphook or carabiner does not assure compatibility
- Compatibility is achieved when dimension “A” is less than “B” below. The snap hook will self-correct in the event of a fall.

July 2017

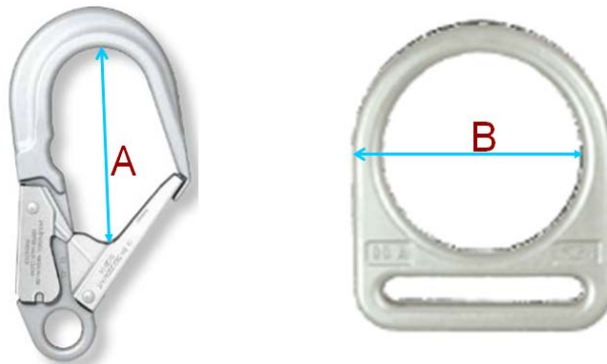

### (b.2) Swing Fall Hazards

Swing fall is what occurs when a person wearing a PFAS that is not anchored directly overhead. If a fall should occur, the person will swing, like a pendulum, back toward the anchor point. In the process, the person could strike – with great force – the structure he or she is working on or another nearby structure. Swing falls can be extremely dangerous. Unfortunately, many people, when working at heights, fail to take swing into consideration.

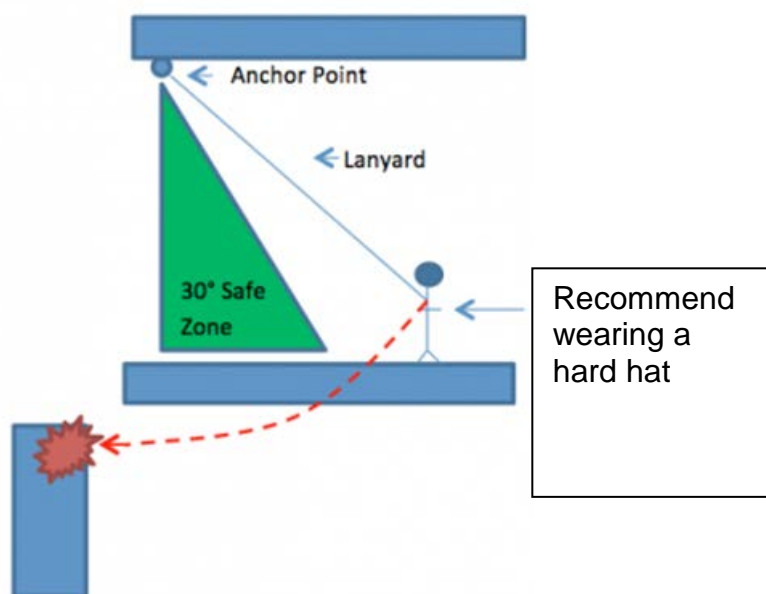

The above diagram depicts just one scenario. The person certainly could be working in an area where there is no other structure to strike. Even if this is the case, there are still hazards to working outside of that 30° safe zone. If the working level is 12 feet off the ground, during work the person wanders 20 feet away from the anchor point – well outside the safe zone, if a fall occurs in this situation the person may not hit another structure, but WILL hit the ground below. Self-retracting devices or lanyards do not recoil during a fall, they just lock. The entire 20 feet of lanyard will remain played-out and the person will strike the ground.

July 2017

This is a very real problem. Most people don their harness and lanyard and give little thought to their fall protection. They pay-out the lanyard as far as they can in any direction they need to go, completely unaware of the swing hazard until it is too late.

### Preventing Swing Fall Hazards:

The only way to prevent swing fall is to stay within a certain distance of the anchorage. The tie-off point should be located above the dorsal D-ring. Swing falls can be prevented by staying within a 30° of the anchorage. The further the person moves away from the anchorage, the further the swing and the harder the strike at structure.

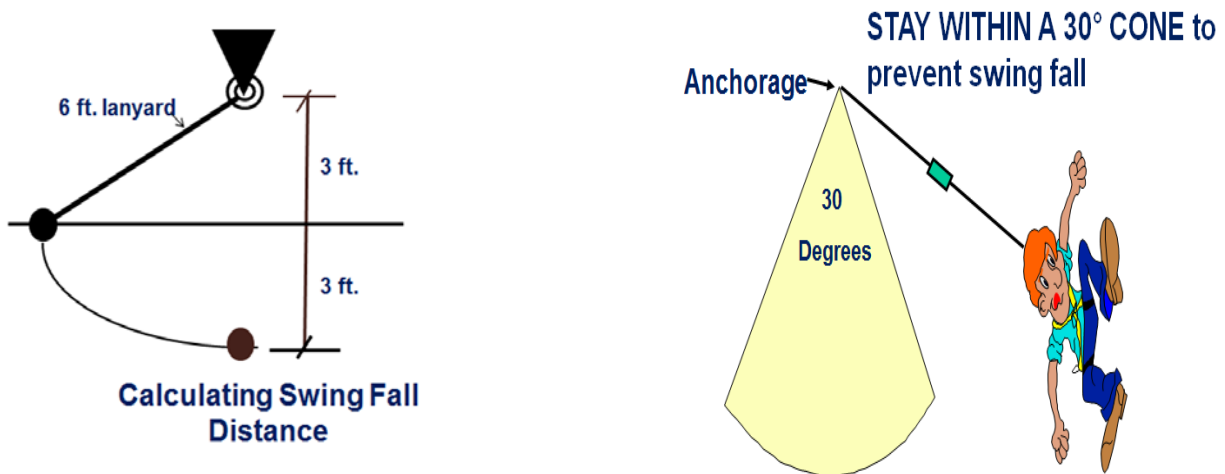

### (c) Self-retracting Devices (SRDs)

SRDs are deceleration devices made of synthetic rope, webbing or wire rope.

- (1) There are four types of SRDs: Self-retracting Lanyard (SRL);
- (2) Self-retracting lanyard with Leading Edge Capability (SRL-LE);
- (3) Self-retracting Lanyard with Rescue Capability (SRL-R)
- (4) A hybrid combination of any two of the above.

**Note: Newly purchased Self-retracting Devices shall be equipped with a visual indicator, which shall be readily visible.**

### SRD Classifications:

SRDs are classified according to dynamic performance.

July 2017

Class A: Maximum Arrest Distance -- 24 inches

Class B: Maximum Arrest Distance -- 54 inches

**(c.1) Self-Retracting Lanyards (SRL):**

The self-retracting lanyard (SRL), also known as a self-retracting lifeline, refers to a wide variety of commercially available devices. An SRL is a device containing a drum-wound line or strap. This line can be slowly extracted from, or retracted onto the drum under slight tension during normal employee movement. After onset of a fall, the line automatically locks the drum and arrests the fall. The SRL is attached to a suitable overhead structural member. A locking snap hook at the end of the webbing or wire rope is attached to the dorsal "D" ring. The mechanism works in a manner similar to a retractable automobile seatbelt. The SRL comes in lengths from a few feet to an excess of a hundred feet in length. SRL advantages include a self-tending lifeline and reduced free fall distance. Disadvantages include high cost, weight of the equipment, requirement for specialized inspections, and the possibility of swinging into an obstruction during a fall if the SRL is extended too far horizontally.

**Requirements:**

(1) The maximum arrest distance shall be as follows:

- Class A – 2 ft.
- Class B – 54 inches

(2) Average arrest force on the body shall not exceed:

- Class A -- 1,350 lbs.
- Class B – 900 lbs.

(3) The maximum peak force shall not exceed 1,800 pounds.

(4) The SRL is typically used in a vertical mode unless permitted by the manufacturer for horizontal application,



July 2017



### Self-Retracting Lanyard

- (6) The SRLs shall meet the requirements of ANSI Z359.14 Standard.
- (7) Used when the tie off point is located below the dorsal D-ring.
- (8) SRL shall be equipped with deployment indicator.

#### Note:

The requirements for self-retracting lanyards prescribed in ANSI Z359.14 Standard supersede the corresponding requirements prescribed in ANSI Z359.1 (2007) Standard.



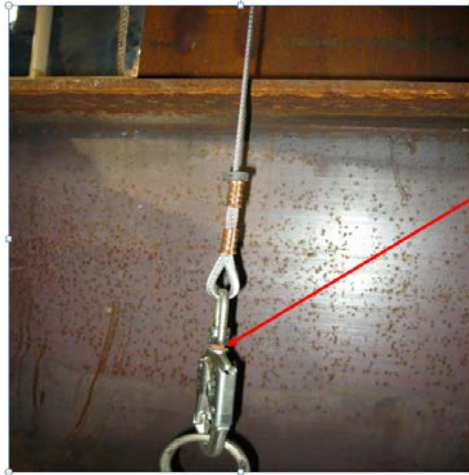

• Red ring is a fall indicator – SRL has been impacted by a fall and must be removed from service

### (c.2) Self-Retracting Lanyards with Leading Edge Capability (SRL-LE)

A SRL-LE is suitable for applications where during use the device is not necessarily mounted or anchored overhead. The device may be at foot level and where the possible free fall is up to 5 feet that includes an integral energy absorber adjacent to the end of the which connects to the FBH to withstand impact loading of the line constituent with a sharp or abrasive edge during fall arrest and for controlling fall arrest forces on the end user. The SRL-LE can be used in horizontal or vertical applications. The line constituent of SRL-LE is made either of synthetic rope, webbing or wire rope. SRL-LE shall meet the requirements of ANSI Z359.14 Standard.

#### Requirements:

- (1) FF distance is 5 ft.,
- (2) The Arrest distance limit do not apply to SRL-LE
  - Class A, Average arrest force = 1,575 lbs.
  - Class B, Ave arrest force – 1,125 lbs.
- (3) SRL-LEs do not necessarily need to be Class A or B but Class B is more common.

These are designed and manufactured for steel erection and it is dangerous for use on other surfaces (i.e. concrete) curved knife. Many manufacturers are having issues with SRL-LE. Using SRL-LE should be the last method selected and used. Even a HLL system is safer than SRL-LE. Additionally, the Fall Arrest distance for class B,

SRL-EL can be more or less than 54 inches the manufacturers will determine the arrest distance from testing the device. Based on this, actually there are more than two classifications of SRL-LEs.

- (4) Equipped with energy absorber which is a pouch made of stitched fabric
- (5) Used in vertical and horizontal applications (may be used in fall-arrest and restraint systems).

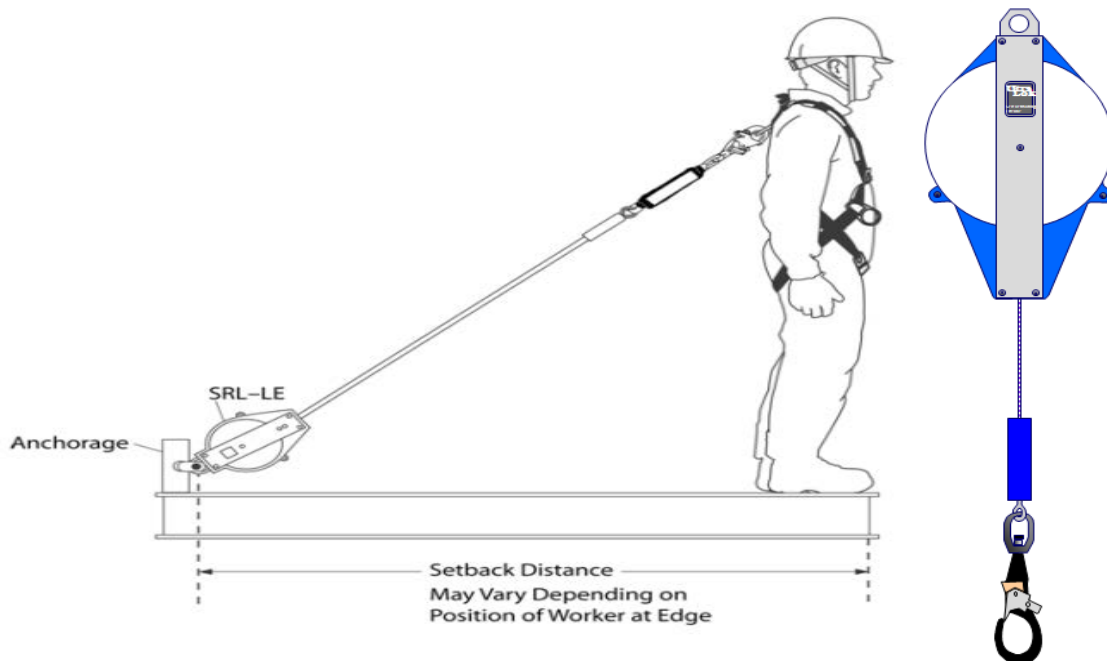

**Self-Retracting Lanyard W/Leading Edge Capability**

### **(c.3) Self-retracting Lanyards with Rescue Capability (SRL-R)**

An SRL that includes an integral means for assisted rescue via raising or lowering the rescue subject. SRL-R must be capable of raising or lowering the load to affect rescue. The device can be made as part of a SRL or SRL-LE as a hybrid component.

- (1) Minimum static strength of 3000 pounds
- (2) Minimum mechanical advantage of 3:1



**(c.4) Hybrid Self-retracting Devices:**

- (1) Combination of two types of the above Self-retracting Devices.

**(c.5) Line Characteristics of Self-retracting Lanyards:**

- (1) Synthetic Rope or Webbing: shall have a minimum breaking strength of 4,500 pounds (20kN)
- (2) Wire Rope: shall have a minimum breaking strength of 3,400 pounds (15 kN).
- (3) Minimum diameter of the line constituent shall be 3/16 inches.



**Personal SRL for 100% tie-off  
Used like a "Y" lanyard**

**(d) Fall-Arrestors (FA):**

A fall arrestor is a device that travels on a rope or cable and automatically engages the line and locks to arrest the fall of a worker. The fall arrestor is a very useful component of a

PFAS when vertical mobility is required. When the rope grab is designed to manually lock, it may be used in a horizontal mode as part of a fall restraint system which is called rope adjuster. Fall arrestor is also used to attach a worker to a climbing ladder fall arrest system using a short connector.

A fall-arrestor is a device that travels on a lifeline and will automatically engage the rope or cable and designed to lock off by inertia to arrest a fall. The device is also called rope or cable grab. Automatic Fall-arrestors shall be used on single anchor vertical lifeline and climbing -ladder fall arrest systems.

- (1) Automatic Rope Grab is best for hands free operation, used only in vertical climbing and descending. The device uses inertia locking mechanisms which rely on the rate of acceleration to lock (simply follows the workers as they climb or descend without holding on the device).** The fall arrestor is a very useful component of a PFAS when vertical mobility is required

#### Note

Requirements for Automatic Fall-arrestor are included in paragraph 8.2.4.3.

- (2) When the rope grab is designed to manually lock, it may be used in a horizontal mode as part of a fall restraint and positioning system which is called rope adjuster.**

Manual



Rope Adjuster

Automatic



Fall Arrestors

#### (e) Body Support (Full-Body Harness):

Straps connected together to contain the torso and distribute the arresting fall forces over the upper thighs, waist, shoulders, chest and pelvis. Full Body harness (FBH) is a fundamental component of every PFAS. All full body harnesses shall permanently incorporate a dorsal attachment element (D-ring) and may contain any combination of other elements and must permanently include a load bearing sub-pelvic strap. All shoulder straps must come together at the dorsal location and either cross or be connected by webbing or attached with a connector. The FBH must permanently incorporate either a waist belt or back strap, or other means of controlling the separation of the shoulder straps on the back of the FBH. The harnesses are either equipped with a chest strap that horizontally connects two vertical shoulder straps or shoulder straps that cross at the chest (X-Style). Full body harnesses used in fall arrest may also be integrally designed into coveralls or vests. An extender element no longer 24 inches may also be used as attachment to the dorsal D –ring. Fundamentally, full body harnesses meeting the requirements of ANSI Z359.11 have the following common characteristics:

## Types of Harnesses

- **Vest Style Harnesses (three Types):**



(1) Equipped with Chest Strap, Sub-Pelvic Strap and Back Strap



(2) Equipped with Chest Strap, Sub-Pelvic Strap and without Back Strap

July 2017



(3) Equipped with Chest Strap, Sub-Pelvic Strap and Waist Belt

- **Cross Over Style Harness (X Harness):**



Equipped with Sub-Pelvic Strap

- **Y-Style Harness (Used for Rope Access):**



Equipped with both Frontal and Sternal D-rings, with Integral Waist Belt and Leg loop suspension straps attached to waist belt (2 at the front and 2 at the back) and without Pelvic Strap

### **Full Body Harness Selection**

Consideration must be given to the following items when selecting the appropriate full body harness:

1. Expected duration that personnel will be wearing the body harness.
2. Body stature and size of personnel assigned (one size does not fit all).
3. Gender of personnel expected to wear the harness.
4. Type of work being performed.

### **Full Body Harness Requirements:**

- (1) Maximum arresting force on the body shall not exceed 1,800 pounds
- (2) Shall be equipped with a dorsal D-ring integrally attached at the upper back between the shoulder blades, or a D-strap incorporated into the full-body harness
- (3) Shall have permanently attached labels stating the manufacturer's name, serial number or lot number, date of manufacture, capacity, annual Competent Person inspection, and that it meets OSHA & ANSI Z359 FP Code/Product Standards requirements.
- (4) The capacity range, including weight of the user, clothing, and tools, shall be from 130 to 310 pounds.
- (5) All Straps must be connected together properly. Load bearing straps shall be minimum 1 5/8 inch wide.
- (6) Conduct a buddy check to make sure the harness is properly donned and connected.
- (7) All newly purchased harnesses shall be equipped with fall-arrest indicator for the Dorsal D-ring and at least one lanyard parking attachment element having a disengagement load of not more than 120 pounds (Required for attaching the unused leg of the "Y" lanyard to the harness) and may include a back strap.

### **(8) Harness Test Weight:**

Manufacturers used to test the harness with a rigid weight of 220 pounds. This was based on the conversion factor of rigid weight to the human body is 1.4. A 220-pound rigid weight is equivalent to 310 pounds of human body weight.

**Latest studies indicated that the conversion factor is closer to 1.1, not 1.4. The new conversion factor of 1.1 was accepted by the ANSI Z359 Accredited Standards Committee. Converting 310 pounds using the new conversion factor is equivalent to 282 pounds of rigid mass. Exceeding the 310-pound weight becomes more critical with a 1.1 conversion factor. All harnesses shall be tested to 282 pounds.**



July 2017

**Note:**

The requirements for full body harnesses prescribed in ANSI Z359.11 Standard supersede the corresponding requirements prescribed in ANSI Z359.1 (2007) Standard.

**Note:**

All newly purchased harnesses shall be equipped with Fall Arrest Indicator located at the Dorsal D-ring and at least one Lanyard Parking Location (Required for attaching the unused leg of the "Y" lanyard to the harness).

**(9) Lineman's Equipment:**

(Use electrically rated harnesses meeting ASTM F887 and ANSI Z359 FP Code/Standards). The full-body harness used around high voltage equipment or structures shall be an industry-designed "lineman's FP harness" that will resist arc flashing and either shall have straps or plastic coated D-Rings and positioning side-rings in lieu of exposed metal D-Rings and exposed metal positioning side-rings. All other exposed metal parts of the linemen's harnesses shall also be plastic coated (e.g., buckles and adjusters). There shall be no metal above the waist or equipped with insulated metal components.



**(Utility harness) Arc Flash Harness**  
**(There is no metal above the waist)**  
**or equipped with insulated Metal Components**

**(10) Criteria for donning of the full-body harness:**

- It is very important and critical the harness shall snugly fit the body;
- The user shall be able to reach the Dorsal D-ring with his or her thumb;
- There shall be a maximum four flat fingers of slack between the legs and the leg-straps;
- Ensure that the chest strap is across the chest/breast bone.

**(11) D-rings and Connectors**

## Requirements:

- (a) Shall have a minimum tensile strength of 5,000 pounds.
- (b) Shall be drop forged, pressed, or formed steel.
- (c) Connectors and D-rings shall have corrosion resistant finish.
- (d) Connectors, adjusters and any buckles used as adjusters shall be capable of withstanding a minimum load of 3,372 lbs. (15 kN) and shall be made of drop forged, pressed or formed steel, or made of equivalent materials.

**(12) D-ring locations on the full body harness and uses:**

- (a) Dorsal “D” ring located at the upper back between the shoulder blades. (Note: In addition to fall arrest, the dorsal attachment may also be used in travel restraint or rescue.)
- (b) A frontal “D”- ring located at the waist for use with climbing ladder fall arrest system (ladder climbing system), work positioning, travel restraint and rescue where there is no chance of a fall other than the feet first.
- (c) Hip D- rings attachment element, located at the side near the hip region, must be used in pairs and must be used solely for work positioning or travel restraint (Note: The hip D- ring attachments are not to be used for fall arrest.)
- (d) Shoulder D- ring attachment elements must be used as a pair, and are acceptable attachment for rescue and entry/retrieval. These “D” rings are located at the top of each shoulder strap and are usually smaller in size than the dorsal “D” ring. (Note: The shoulder attachment elements must not be used for fall arrest.)
- (e) Sternal D- ring. The sternal attachment is located at the sternum and is used as an alternative fall arrest attachment in applications where the dorsal attachment is determined to be inappropriate by the competent person for fall protection and where there is no chance to fall in a direction other than the feet first. The sternal attachment should be used only when the likely fall distance is not greater than 2 ft. (Note: The sternal attachment may also be used for travel restraint or rescue in addition to climbing ladder fall arrest system.)
- (f) Waist, Rear. The waist, rear attachment shall only be subjected to minimal loading through the waist of the user and shall not be used to support the full weight of the user. (Note: the waist rear shall only be used for travel restraint).

- (g) Saddle (pairs). Used with suspension seat and shall be used only for work positioning.

**Other Accessories:**

- (a) Waist belts, depending upon the design, may be integral to the full body harness and necessary for proper use; or simply a convenience for attaching tools, carrying pouches, or providing lower back support.
- (b) Shoulder pads (used in pairs), leg padding, integral elastic webbing, and a wide variety of other features that add commercial viability to products.



- (13) Integrated Equipment Used with the Harness:** include Vest, Suspension Seat, Extender, Dorsal or other specialized attachment elements.

July 2017

**Extenders:**

- Extender is short extension designed to be attached to the dorsal D-Ring of harness (No longer than 24 inches).
- Makes it easier for end user to grab extension and snap on retractable.

**(f) Ropes:****Requirements**

- (1) Synthetic rope lifelines: minimum strength of 5,600 pounds.
- (2) Wire rope lifeline: minimum strength of 6,000 pounds.
- (3) Vertical lifelines: minimum strength of 5,000 pounds.

**8.2.3 OTHER ACTIVE FALL PROTECTION SYSTEMS****8.2.3.1 FLEXIBLE HORIZONTAL LIFELINE (HLL) SYSTEM**

A horizontal lifeline (also called catenary line or static line) is a fall-arrest system, consists of a flexible rope, wire, or synthetic cable that is installed on a horizontal plane (or minimally sloped up to 5%) between two end anchorages and used for attachment of a worker's lanyard or lifeline device which moves horizontally on the horizontal lifeline. A horizontal lifeline is used to control dangerous pendulum-like swing falls. **A Qualified Person for Fall Protection** must design the system. The Competent Person for Fall Protection may supervise the assembly, disassembly, use and inspection of the HLL systems, under the direction of the QP.

The HLL shall be designed, installed, certified, and used under the supervision of a Qualified Person for Fall Protection, as part of a complete fall-arrest system, which maintains a safety factor of 2. Horizontal lifelines can be either permanent or temporary systems.

**DESIGN CONSIDERATIONS FOR FLEXIBLE HORIZONTAL LIFELINES:**

**a. Certain parameters should be taken into consideration when designing horizontal lifelines, such as:**

- (1) Initial and maximum deflection or sag of the line.
- (2) Clear span between supports or anchorages.
- (3) Design of anchor points and anchorage connectors.
- (4) Number of workers attached to the system.
- (5) Free-fall distance and total fall distance.
- (6) Minimum clearance below horizontal lifeline system.
- (7) Unit weight of the cable and the line.
- (8) Total weight of all workers attached to horizontal lifeline.



**HLL**

**b. The components of typical Horizontal lifeline sub-system may include the following:**

- (1) Anchorages and anchorage connectors.
- (2) Lifeline tensioner.
- (3) Cable or rope.
- (4) In-line energy absorber
- (5) Mobile attachment device



**Mobile Attachment Device**  
for moving between  
intermediate anchorages



**HLL components**



**Shock absorber**



**Tensioner**

**c. There are two types of HLL systems:**

- **Type 1: Flexible HLL system is designed by the manufacturer of the system and installed and used by the purchaser (or purchaser's representatives) in accordance with manufacturer's requirements.**
- **Type 2: Flexible HLL system is designed and installed by the manufacturer and used by the purchaser of the system (or their representatives) in accordance with manufacturer's requirements.**

**d. ANSI is developing a new horizontal lifeline standard. Verification testing requirements may include the following tests:**

- (1) Line fittings static test
- (2) Corrosion Inspection

**Unfortunately, with a factor of safety of two, many tests have the potential to activate the lifeline system. Careful consideration is required in determining testing requirements.**

**e. Additional Requirements**

- (1) Locally manufactured HLLs are not acceptable unless they are custom designed for limited or site-specific applications by a registered professional engineer who is also qualified in designing HLL systems.
- (2) Commercially manufactured HLLs shall be designed, installed, certified and used under the supervision of QP for FP only, as part of a complete fall-arrest



July 2017

system. The CP for FP may (if deemed appropriate by QP for FP), supervise the assembly, disassembly, use and inspection of the HLL systems, under the direction of the QP for FP.

(3) The design of the HLL shall include drawings, required clearance, instructions on proper installation, and use procedures, proof testing reports and inspection requirements.

**(4) All HLL anchorages shall be designed by a Registered Professional Engineer who is also qualified in designing HLL systems.**

(5) The factors that should be taken into consideration for calculating the minimum required clearance for HLL systems include free-fall distance, initial sag of the line, maximum dynamic deflection, length of the lanyard or lifeline, activation distance, of self-retracting lanyards, deployment of energy absorbing lanyards, harness stretch and a safety margin.

**Note:** Depending on the angle of sag and the line's elasticity, the forces generated by a fall are greatly amplified at the anchorages.

### Angle of Sag

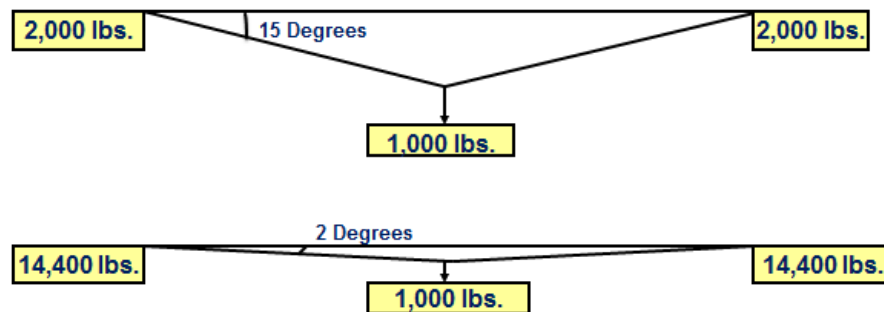

- **Minimizing angle of sag of the HLL will amplify or increase the impact of fall forces at the anchorages**

### 8.2.3.2 RIGID HORIZONTAL RAIL SYSTEM (RHRS)

RHRS is a fall protection system that utilizes one or more mobile attachment devices on a horizontal track system and can be either single or multi span supported at intermediate points along the length.

- Pre-engineered and manufactured System;
- Shall only be designed under the supervision of a QP;
- Installation, use and inspection of RHRL may be performed by CP under QP supervision;



- Examples of the RHRs included monorails, bridge and runways swing arms, and folding monorails supported by existing roofs, ceilings, walls, columns, building facades or freestanding, movable free standing or ballasted free standing;
- The system may consist of horizontal track system, anchorage connectors, intermediate anchorages and mobile attachments.
- The mobile attachment device may also travel on the outside or the rail such as an I-beam or other structural shaped slotted tube.
- **Two type of RHRs:**
  - **Type 1: System is designed by the manufacturer of the system and installed and used by the purchaser (or purchaser’s representatives) in accordance with manufacturer’s instructions and requirements.**
  - **Type 2: System is designed and installed by the manufacturer and used by the purchaser of the system (or their representatives) in accordance with manufacturer’s instructions and requirements.**



Rigid Horizontal Rail Systems

### 8.2.3.3 SINGLE ANCHOR VERTICAL LIFELINE SYSTEM

- A single anchor vertical lifeline is a vertically suspended line attached to a fixed overhead anchorage independent of the walking/working surface to which a lanyard or device is attached. When single anchor vertical lifelines are used, each employee shall be attached to a separate lifeline. There shall not be

July 2017

more than one worker attached to a vertical lifeline. Each worker requires his/her independent vertical lifeline.

- Single Anchor Vertical Lifelines shall be protected from sharp edges, and against being cut or abraded by using chafing material.
- The system consists of a fall-arrester attached to a lanyard which is connected to a harness, and designed to move up or down a lifeline (synthetic or wire rope).
- **Single anchor vertical lifeline can be used in vertical, sloped or horizontal applications.**



**Single Anchor VLL**

#### **System Requirements:**

- (1) Shall have a minimum breaking strength of 5,000 pounds
- (2) Connected to an overhead anchorage that can withstand a force of 5,000 pounds.

#### **Types of Ropes used in Single Anchor Vertical Lifeline Systems:**

- **Synthetic Rope:**
  - Made of Polyester, Polypropylene or Nylon;
  - Man-made yarns, fibers or filaments
  - Minimum breaking strength of 5,600 pounds
- **Wire Rope:**
  - Drawn wires forming strands laid helically over a core or axis;
  - Minimum breaking strength of 6,000 pounds;
  - Minimum diameter of 5/16 inch.

#### **Automatic Fall Arrestors used in Single Anchor VLL and Descending Applications:**

A fall arrestor is a device that travels on a rope or cable and automatically engages the line and locks to arrest the fall of a worker. The fall arrestor is a very useful component of a PFAS when vertical mobility is required. When the rope grab is designed to manually lock, it may be used in a horizontal mode as part of a fall restraint system which is called rope adjuster. Fall arrestor is also used to attach a worker to a climbing ladder fall arrest system using a short connector.

### **Requirements:**

- **Average arrest force on the body shall not be greater than 900 pounds;**
- **Maximum arrest force shall not exceed 1,800 pounds;**
- **Maximum arrest distance shall not exceed 54 inches;**
- **Shall be automatic in their locking;**
- **The total fall distance shall not be greater than 11 feet;**
- **The FA shall not creep more than 4 inches on the rope during a fall.**

### **Proper Usage:**

- **If the FA has directional arrow on it, make sure it is pointing along the lifeline to the anchorage. The gravity feed latches prevent the worker from accidentally placing the FA incorrectly on the lifeline.**
- **After mounting on the lifeline, check to ensure the fall arrestor is working properly by pulling down sharply.**
- **During a fall, the user may grab on the FA and inadvertently hold it open, the new fall arrestors will be equipped with panic grab; even when the user holds the FA open, it will self-lock and arrest the person automatically.**
- **Fall arrestors are designed to work with certain types and diameter of ropes or cable.**
- **Use only automatic travel fall arrestors in vertical or descending applications.**
- **Fall arrestor and the rope/cable must be compatible.**
- **Make sure the appropriate size and type of lifeline is used. The required size is marked on the fall arrestor.**

## **8.2.3.4 CLIMBING-LADDER FALL ARREST SYSTEM (LADDER CLIMBING DEVICE SYSTEM)**

A vertically oriented system consists of assembly of components whose function is to arrest the fall of a user. The system includes a flexible or rigid carrier, and its

associated mounting brackets, and the carrier sleeve. The carrier is securely attached to the climbing ladder or to the immediately adjacent structure. The system must permit the employee wearing a full body harness to ascend or descend without continually having to hold, push or pull the carrier sleeve, leaving both hands free for climbing or descending. The specifics on climbing ladder fall arrest system can be found in references 13-1 thru 13-5.

Climbing Ladder FA system is installed on fixed ladders over 20 feet in length. The 20 feet is the length of the climb (does not include side rail extension of 3 1/2 ft.).

The carrier is made of rigid rail, cable, or rope;

- (1) Anchorage strength requirement is 3,000 pounds;
- (2) Free-fall distance shall not exceed 2 feet;
- (3) The connector from the frontal D-ring to the tie-off point on the ladder (rope or cable grab) shall be 9 inches long;
- (4) Do not attach or install climbing-ladder fall arrest system to off-the-shelf ladders. Per OSHA standard, fixed industrial ladders (off the shelf) having  $\frac{3}{4}$  inch rungs are designed to withstand a static load of 500 pounds (Weight of 2 persons). Make sure the ladder is adequate for attaching the Climbing-ladder fall arrest system to it due to the high forces generated by a fall. If a fall occurs, the  $\frac{3}{4}$  inch rungs will not sustain the forces imposed on the ladder; specifically when a cable is used as part of the climbing system;
- (5) Attachment point to the body harness shall be either to the sternal (frontal) D-rings. Consult the manufacturer for the proper connection point;
- (6) There shall be 100% transition at the top of the ladder.



### 8.2.3.5 RESTRAINT SYSTEM

Restraint system can be used on horizontal, or mildly sloped, surfaces between 0 and 18.4 degrees (Up to 4 vertical into 12 horizontal).

The system consists of

- (a) A safety harness (full-body harness) attached to securely rigged restraint lines;
- (b) **According to OSHA, anchorages used for restraint shall withstand a minimum force of 3,000 pounds unless engineered. According to ANSI Z359.2, the selected restraint anchorages shall be capable of sustaining a 1,000-pounds static load (non-certified anchorages), twice the foreseeable force for certified anchorages or as determined in accordance with ANSI Z359.6 standard. Keep in mind that OSHA is the law.**
- (c) The restraint system shall be rigged to allow the movement of employees only so far as the sides and edges of the walking/working surfaces. The person shall not be exposed to a fall hazard;
- (d) Fall-arresters and self-retracting lanyards are prohibited for use as part of a restraint system, or in horizontal applications unless permitted for such use by the manufacturer (using self-retracting lanyard with leading edge capability).
- (e) Lanyard with energy absorbers may be used in a restraint system provided the engineer who is a Qualified Person, has determined whether or not the restraint force could cause the personal energy absorber to deploy, and if so, that such deployment will not permit the worker to reach the Fall-Hazard.
- (f) When using flexible anchorage system such as a horizontal lifeline system as part of a restraint system, pay special attention on how short the lanyard or lifeline needs to be in order that the worker will not reach a Fall-Hazard condition.
- (g) The lanyard length used in restraint system can be longer than 6 feet.
- (h) There are two types of restraint lanyards:
  - Type A - Non Adjustable;
  - Type B – Adjustable.

Note 1:

The terms: *Restraint System, Travel Restraint, Fall Restraint, Work Restraint* and *Travel Restriction*, used and referenced in the ANSI Z359 Fall Protection Code/Standards are the same.

Note 2:

It is highly recommended to design or select anchorages for the restraint system as if they were fall-arrest anchorages. It is also recommended that energy-absorbing lanyard be considered and used as part of the restraint



system. These precautions would provide some level of protection, in the case of system misuse.



### Restraint System

## 8.2.4 OTHER FALL PROTECTION SYSTEMS

### 8.2.4.1 POSITIONING SYSTEM

The system consists of body harness and a short lanyard attached to a vertical work surface. **Although allowed by OSHA**, ANSI Z359 FP Code/Standards and this guide do not permit the use of a body belts by itself; at a minimum, the body belt shall be incorporated in a harness. Positioning system also referred to as personal fall protection system.

#### System Requirements:

- (1) The system consists of anchorage, one or two short lanyards, and body support, usually a full-body harness and another system as backup.
- (2) The system shall be rigged so that a person cannot free-fall more than 2 feet.
- (3) The system shall be attached to an anchorage capable of supporting 3,000 pounds, or twice the potential impact load of the worker, whichever is greater.
- (4) Lanyards used positioning lanyards can be either fixed or adjustable.

July 2017

**Note:**

The positioning system (if used alone) is not considered Fall Protection. A positioning system shall not be used as a primary Fall Protection system. A positioning system will require an additional, separate system used as back-up to protect the person from falling.

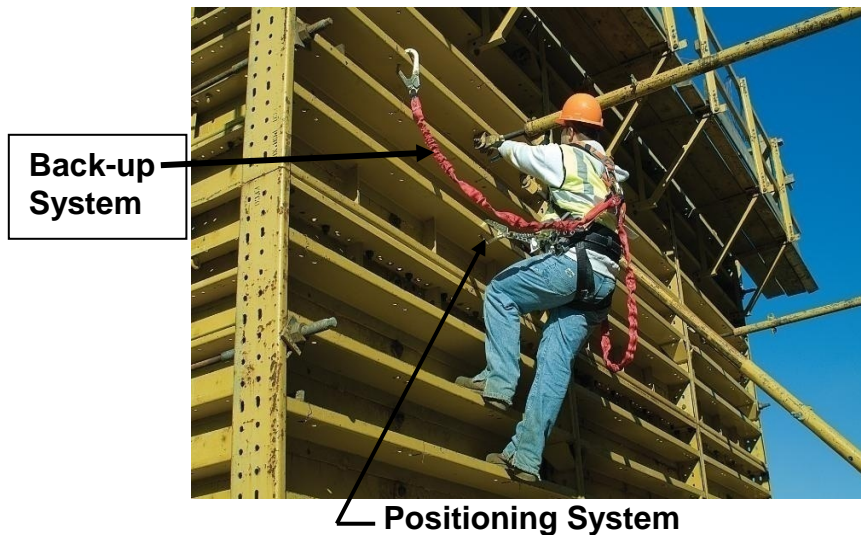

#### 8.2.4.2 WARNING LINE SYSTEM

A warning-line system used during construction work is a barrier erected on a walking and working surface or a low-pitched roof having a slope less than or equal to 4 in 12 (vertical to horizontal), or less than 18.4 degrees, to warn workers that they are approaching a Fall-Hazard.

A warning line system must be erected around all sides of the work area during construction work. Where mechanical equipment is not being used, the warning line shall be erected not less than six (6) feet from the edge of the roof. When mechanical equipment is being used, the warning line shall be erected not less than six feet from the roof edge which is parallel to the direction of mechanical equipment operation. The warning line shall be not less than 10 feet from the roof edge perpendicular to the direction of mechanical equipment operation. OSHA considers the use of a warning line system a *De-Minimis* violation of the guardrail criteria.

Warning lines shall have the appropriate OSHA compliant flag attached to them.





Warning Line System

**(a) For roofing work:**

- (1) The line is installed six to ten feet away from a leading **edge**, and flagged every 6 feet; provide signage stating “warning line.”
- (2) Shall consist of a rope, wire, or chain, and supporting stanchions.
- (3) A safety person, whose sole job is observation and ensuring a safe working environment, shall be present;
- (4) On minimum sloped surfaces, the line shall be erected 15 feet from the unprotected roof edge.

**(b) For other construction trades working on roofs:**

The line shall be installed 15 feet away from the edge of the roof. Other requirements for warning line system are the same as for roofing work.

### **8.2.4.2.1 WARNING LINE SYSTEM REQUIREMENTS**

- (a) The line consists of rope, wires or chains, 34 to 39 inches high, flagged every 6 feet.
- (b) Supporting stanchions shall be capable of resisting a 16-pound force applied horizontally 30 inches high from the base of the stanchion.
- (c) The wire, rope or chain shall have a minimum tensile stress of 500 pounds.

### **8.2.4.3 DESIGNATED AREA**

Designated area is a system used during general industry work on flat or minimum sloped roofs for conducting work, of mechanical equipment (other than roof

inspections), or conducting other general industry work (e.g., HVAC repairs). **The requirements for Designated Area are identical to the warning line system prescribed in paragraph 8.2.4.8.1 above.** In addition to the requirements of the warning line system, a 100% transition is also required from the access point to the designated area. The minimum breaking strength of the line is 200 lbs.

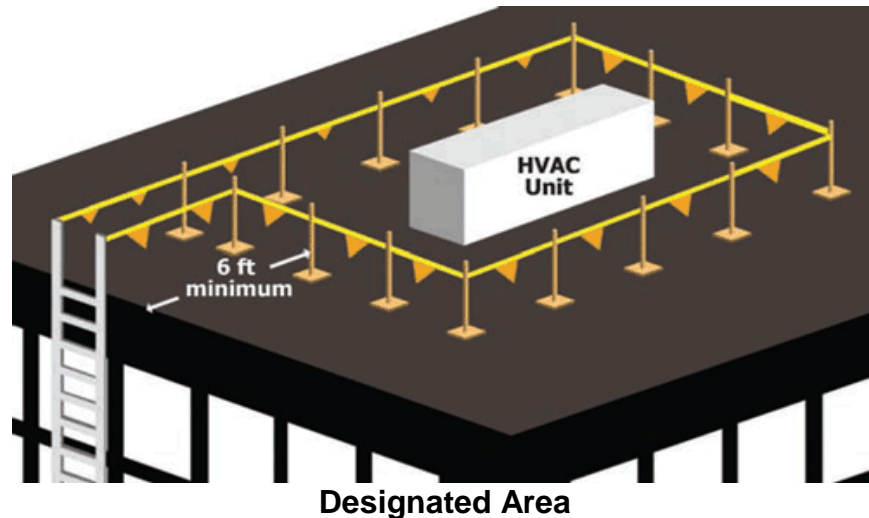
**Note**

Designated area is used for maintenance evolutions (General Industry Work), see Paragraph 9.1.

**8.2.4.4 OTHER ENGINEERED FALL PROTECTION SYSTEMS**

Commercially available engineered/integrated systems are recognized as effective Fall Protection and may be used. These are systems that are not addressed in this chapter. These commercially available engineered systems shall be designed, installed, certified and used under the supervision of a QP for FP only. They shall be used per manufacturer's instructions and recommendations. The CP for FP may (if deemed appropriate by the QP for FP), supervise the assembly, disassembly, use, and inspection of the engineered system, under the direction of the QP for FP. The design shall include drawings, required clearance, and instructions on proper installation, use, and inspection requirements.



Sky Web

#### 8.2.4.5 SUSPENDED ROPE ACCESS

**Requirements:**

- (1) Two independent anchorages.
- (2) Two lifelines or ropes attached to the anchorages, a working line, and a back-up safety line. Each one is to be independently anchored.
- (3) Ropes should be of low-stretch kern mantle and arranged so that any abrasion will be avoided.
- (4) Use full-body or Y-Style harness.



### **8.2.4.6 LADDER CAGES**

Ladder cages may be required per varying standards and regulations, but it must be clearly understood that the installation and or use of cages does not provide adequate protection or mitigation of Fall-Hazard.

**Note: Although presently allowed by OSHA, Ladder cages or “wells” do not provide safe Fall Protection. They cannot stop a fall. The purpose of the ladder cage is to afford the worker the ability to lean back and support himself or her-self if necessary to rest during climbing.**



**Note**

**For additional requirements on phasing out of ladder cage usage, see Paragraph 9.11.1.2**

## **8.2.5 PROHIBITED FALL PROTECTION SYSTEMS**

### **8.2.5.1 SAFETY MONITORING SYSTEM (COMPETENT PERSON)**

The safety monitoring system shall not be used as a Fall Protection method. “Unified Facilities Guide Specification UFGS 01 35 26 titled Governmental Safety Requirements” and USACE EM 385-1-1 latest edition prohibits the use of the safety monitor as a Fall Protection method.

July 2017

### **8.2.6.2 CONTROLLED ACCESS ZONE**

- **Controlled access zone shall not be used as a Fall Protection system.**

**End of Section**

## 9.0 FALL PROTECTION GUIDELINES FOR SPECIFIC WORK APPLICATIONS

### Note:

For additional discussion, examples, problems, solutions and applications to specific Fall-Hazards, see Appendix C

### 9.1 REQUIREMENTS FOR ROOF WORK

#### 9.1.1 General Industry Work, Final Rule

##### **Work on Flat or Low-Sloped Roofs Less than 4/12 slope**

- When work is performed less than **6 feet** from the unprotected roof edge, ensure each employee is protected from falling by the use of conventional fall protection system (guardrail system, safety net system, travel restraint system, or personal fall arrest system). **Designated area** is not permitted.
- When work is performed at least **6 feet but less than 15 feet** from the unprotected roof edge, ensure each employee is protected from falling by using a guardrail system, safety net system, travel restraint system, or personal fall arrest system. The use of **designated area** is also acceptable when performing work that is both **infrequent and temporary**. For lengthy or routine jobs involving exposure to fall hazards, only conventional fall protection systems are permitted
- When work is performed 15 feet or more from the roof edge:
  - Each employee shall be protect from falling by the use of guardrail system, safety net system, travel restraint system, or personal fall arrest system or a designated area. Fall protection is not required, provided the work performed is both **infrequent and temporary**; for lengthy or routine work, use conventional fall protection systems or designated area.
  - Implement and enforce a work rule prohibiting employees from going within 15 feet of the roof edge without using fall protection system.

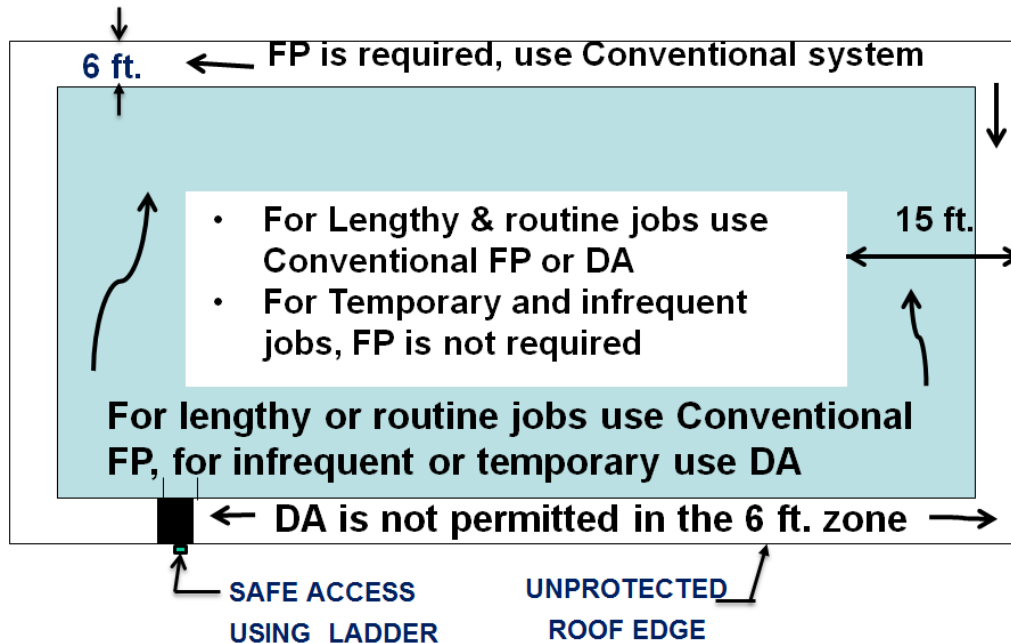
**Note:**

For definitions of Infrequent and Temporary work see Chapter 2.

- For steep roofs fall protection is required, use only conventional fall protection systems (guardrail or personal fall protection systems).

### 9.1.2 CONSTRUCTION WORK

#### Working within six feet of unguarded roof edge having a slope less than 4/12

During performance of construction work on low-pitched roofs with a potential Fall-Hazard greater than 4 feet, ensure that employees engaged in such work shall be protected from falling from all unprotected edges of the roof as follows:

- Use restraint or fall-arrest systems, or
- Use warning-line system for personnel working more than six feet away from the unprotected edge.
- Mechanical equipment shall be used or stored only in areas where employees are protected by a warning-line system, restraint, or fall-arrest systems.
- On flat roofs with no parapet or guardrails: When working 6 feet from the edge, use a full-body harness and lanyard for restraint system. Establish a warning line system or designated area six to ten feet away from the unprotected edge



or temporary guardrails for roofing work without fall-arrest system. Personnel working within the warning line system do not require Fall Protection. For other trades (i.e. mechanical work) the warning the line shall be installed 15 feet away from the edge.

- **Steep roof (greater than a 4/12 pitch):**

A fall-arrest or guardrail system shall be used when working on steep roofs. Warning line and safety monitor system are prohibited on surfaces exceeding a 4 in 12 pitch, and on any surface whose dimensions are less than 45 inches in all directions. Use a full-body harness, self-retracting device, roof brackets/anchors for anchorage points (single or multiple connections designed for 5000 pounds per person). Also use slide guards.

**Note:**

**For fall protection requirements for accessing and conducting inspection, investigation or assessment work on roofs for the purpose of roof replacement, see Chapter 16 and Appendix C, Paragraph C.6.**

## **9.2 INSPECTION, INVESTIGATION AND ASSESSMENT WORK (FOR GENERAL INDUSTRY)**

### **Fall Protection Requirements when Performing Inspection, Investigation and Assessment of Workplace Conditions for General Industry Work (i.e. Mechanical equipment) conducted on flat or Low sloped roofs (Final Rule Exemption)**

- When inspection and investigation work of workplace conditions (i.e. mechanical equipment) is performed prior to start of work or after work has been completed, **fall protection is not required, except:**
- When FP systems or equipment have been installed and are available for workers to use for pre-work and post-work inspections, investigations or assessments, the above exemption does not apply.
- When inspection, investigation or assessment work is performed within 6 ft. of unprotected roof edge, conventional fall protection system is required which includes, guardrail, safety nets or personal fall protection system. **(DON Requirement)**

- When inspection, investigation work of mechanical equipment is performed on steep roofs (more than 4/12 slope), conventional fall protection systems is required.
- When **mobile mechanical equipment** is used to perform work that is both infrequent and temporary in the designated area, the warning line shall be erected from the unprotected roof edge:
  - No less than 6 ft. that is parallel to the direction in which mechanical equipment is operated, and
  - Not less than 10 ft. that is perpendicular to the direction in which mechanical equipment is operated

### For Infrequent and Temporary work

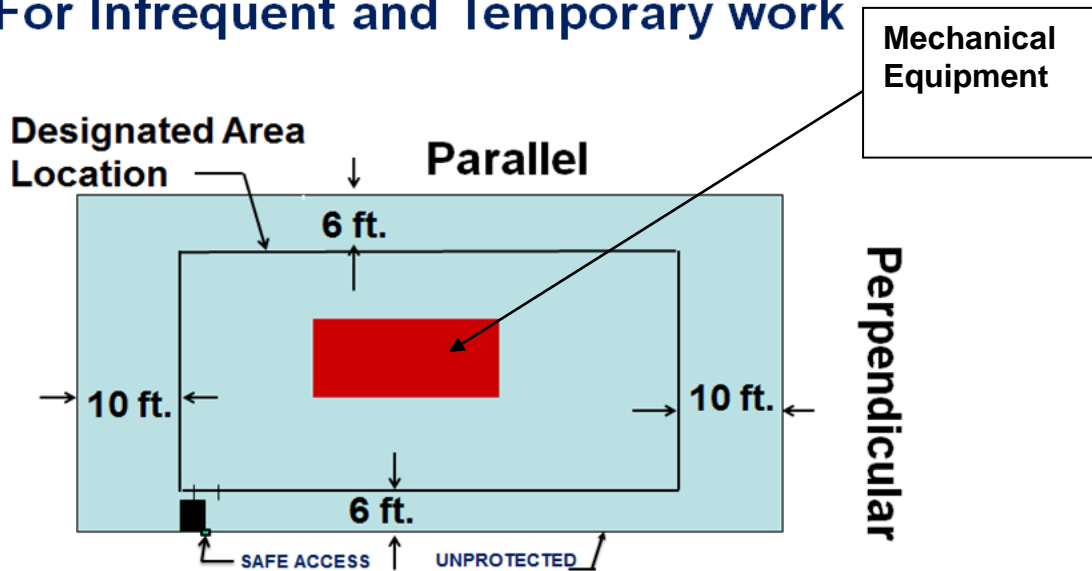

#### Note:

For additional information regarding General Industry Workplace Conditions, see Chapter 16 and Appendix C, Paragraph C.6

## 9.3 COMMUNICATION TOWERS

### MAINTENANCE WORK

- The preferred method for access to existing towers for the performance of maintenance work is by the use of fixed ladders with attached climbing devices

because it provides conventional Fall Protection during ascent and descent of the structure.

- To secure permanent anchorage on the tower, the first worker to ascend is the one who installs the self-retracting lanyard for the next worker's use. Work on the tower requires a portable anchor, full-body harness, use of a self-retracting lanyard (SRL), ladder-climbing device, or fall arrestor;
- After permanent anchorage is secured in place, workers who follow the first person up shall require full-body harness, a SRL, single anchor vertical lifeline, climbing fall arrest system, and/or rope grab;
- When working on towers, workers are required to wear fall-arrest equipment at all times.
- All climbing facilities shall be visually inspected daily for rust, corrosion, deterioration, or other hazards on the climbing facilities that could lead to death or injury of an employee in the performance of their duties, at the base of the structure by a Competent Person. Additionally, the climbing facilities shall be visually inspected for these items by the employees as they ascend to the elevation point where work is being performed. If any such hazard is identified during inspection, employees shall not use the climbing facility until such hazards are abated.

## 9.4 TOWER ERECTION

### Personnel Lifting

Before an employee may perform any job related to the hoisting of personnel aloft for work, the employees shall receive training on safe access. The operator of the hoist shall have thorough understanding and comply with sub-rules (1) through (7) of hoisting personnel on hoist lines, as well as following all applicable requirements of P307, USACE EM 385-1-1 and 29 CFR 1926.

(1) An anti-two-block device shall be used on all hoist lines, except where ambient radiation frequency (RF) precludes that use. In such case, a site-specific site rigging site plan shall be established and maintained on site to ensure that two-blocking cannot occur, and that effective communication between the hoist operator and personnel being lifted is maintained at all times.

(2) A trial lift of the maximum intended personnel load shall be made from ground level to the location to which personnel are to be hoisted.

(3) A pre-lift meeting shall be held before the trial lift at each location and each time a new employee is assigned to the operation.

(4) The Safety Office shall ensure that all trial lifts, inspections, and proof tests shall be performed and documented, and the documentation shall remain on site during the entire length of the project or task.

July 2017

(5) Employees shall be hoisted to their work stations by using a personnel platform, boatswains chair and/or boatswains seat type and full-body harness.

(6) Employees being hoisted shall remain in continuous sight of, and/or in direct communication with, the operator or signal person.

(7) Employees shall not be hoisted during adverse weather conditions (high winds, electrical storms, snow, ice or sleet) or other impending danger, except in the case of emergency employee rescue.

## **9.5 LEADING EDGE WORK**

- Use horizontal lifelines with full-body harness, and lanyard/self-retracting device, roof anchors, temporary guardrail system, or a restraint system.

## **9.6 SCAFFOLD WORK**

- Use guardrails, cross bracing or full-body harness, and lifelines. During erection and dismantling operations it is highly recommended to have a Fall Protection system. During erection and dismantling of scaffolds an evaluation shall be conducted by the Competent Person to determine the feasibility and safety of providing Fall Protection.
- On supported scaffolds over 20 feet high, use stairs instead of ladders to access the scaffold.

## **9.7 SUSPENDED SCAFFOLDS INCLUDING SINGLE AND TWO POINT SUSPENDED SCAFFOLDS**

- In addition to railing, use an independent single anchor vertical lifeline connected to a full-body harness for every worker in suspended scaffolds.
- Full-body harness is to be connected to the fall-arrester (rope grab) on the single vertical lifeline with a lanyard no longer than 3 feet;
- The rope of the vertical lifeline shall be of the material and diameter compatible with requirements as marked on the fall-arrester;
- The suspended scaffold shall be maintained in accordance with manufacturer's instructions and specifications.



Single Point Scaffold

Two Point Scaffold

## 9.8 WORK-STANDS, STATIONARY WORK PLATFORMS AND CATWALKS

- Work-stands, stationary work platforms, and catwalks shall be equipped with guardrails or other Fall Protection system(s). For safer work-stands, provide a swing gate at the platform level near the stairs to prevent a worker from unintentionally moving backward and falling down the stairs.



Work Stand

## 9.9 AERIAL WORK PLATFORMS

### APPLICABLE EQUIPMENT:

1. Vehicle mounted Rotating and Elevating Aerial Devices -ANSI A92.2 (Figure – 1)
2. Manually Propelled Elevating Work Platforms - ANSI A92.3 – (Figure – 2)
3. Boom Supported elevating Work Platforms - ANSI A92.5 (Figure - 3)
4. Self-Supported Elevating Work Platforms/Scissor Lifts - ANSI A 92.6 (Figure – 4)

**Note: Platform means a portion of aerial work platform (AWP) such as bucket, basket, stand or equivalent that is designed to be occupied by personnel.**

### 9.9.1 AERIAL LIFT EQUIPMENT

- Aerial Lifting Equipment including Vehicle mounted Rotating and Elevating Aerial Devices (**ANSI A92.2 equipment**) and Boom Supported elevating Work Platforms (**ANSI A92.5 equipment**) usually have either a platform surrounded by guardrails (e.g., JLG) or a basket (i.e., “cherry picker”) used to raise and lower employees.

Aerial lifting equipment that has a boom (articulating or non-articulating) sometimes is subjected to “hanging up” on a protruding object while being raised, and jolting the man-platform or basket when releasing from the caught projection. This upward jolt can propel (eject) an employee from the man-platform or man-basket. Employees in an aerial lift must be connected with a restraint system. Occupants always shall stand firmly on the floor of the basket, and shall not sit or climb on the edge of the basket or use planks, ladders, or other devices for a work positioning.

- Occupants in aerial lifts shall always be tied off using a restraint system to protect an employee from being ejected from the man-platform or man-basket. It is important that the restraint system keep the employee from being ejected over the guardrail or out of the basket. If an employee were to be ejected over the guardrail, the resulting momentum force could be sufficient to tip over the aerial lift, if the boom were raised high enough and the resulting momentum forces great enough. The best connecting device option is an adjustable energy absorbing lanyard.
- Always use a full-body harness in a restraint system. Aerial lifts often have designed anchorages at the platform level, knee level, or waist level. Depending on the level of the anchorage point and the tie-off point on the full-body harness (at the dorsal D-ring), the lanyard selected must be short enough to prevent ejection from the man-platform or man-basket. For example, if an employee were wearing a full-body harness with a six-foot lanyard connected to the dorsal D-ring, the lanyard necessarily would be connected at the foot level in order to prevent ejection over the guardrail or out of the basket. Exception: A six-foot lanyard could be used connected to an anchorage higher than foot level, if it were a tie-back or adjustable style in which the lanyard could be shortened. A lanyard with a shock-absorber can be used in a “restraint system” since the employee will not experience forces great enough to deploy the shock-absorber.
- Before elevating the work platform of a boom-supported articulating lift, the operator shall verify that all occupants’ full-body harnesses are on, and donned properly.
- The use of self-retracting devices is not permitted in aerial lifts.



## 9.9.2 SCISSOR LIFTS

- **Self-Supported Elevating Work Platforms/Scissor Lifts (ANSI A92.6 Equipment)** four feet or higher shall be equipped with standard guardrails. In addition to the guardrail provided, the equipment shall be equipped with anchorages meeting ANSI Z359, Fall Protection Code/Standards.
- A restraint system shall be used in addition to guardrails. Lanyards used with the restraint system shall be sufficiently short to prohibit workers from climbing out of, or being ejected from, the platform. It is highly recommended to use adjustable energy absorbing lanyards. Scissor lifts equipped with anchorages that do not meet ANSI Z359, Fall Protection Code/standards shall not be used or shall be removed from service. Should the worker's feet leave the floor of platform of the elevated scissor lift, or the worker is required to exit the lift at height, continuous Fall Protection must be provided. The worker must be connected to an anchorage point outside of the scissor lift or mobile scaffold before opening the swing gate and stepping out of the work-platform. The worker must not be simultaneously connected to the work-platform and to an anchorage point located outside the work-platform, in case the scissor lifts were to travel.

## 9.9.3 MOBILE SCAFFOLDS

- **Manually Propelled Elevating Work Platforms (per ANSI/SIA A92.3).** The platform of the mobile scaffolds shall be equipped with standard guardrail. In addition to the guardrail provided, if the platform is equipped with a manufactured anchorages meeting ANSI Z359 Fall Protection Code, a restraint system shall be used in addition to the guardrails. Lanyards used with the restraint system shall be sufficiently short to prohibit workers from climbing out of, or being ejected from the platform. Lanyards with built-in shock absorbers are acceptable. The use of a self-retracting device is not acceptable.
- The platform shall not be occupied when moved and at no time will workers be allowed to climb on or over the guardrails. In case the wheels of mobile scaffold are chocked and brakes locked; then the workers should be connected to a "restraint system". The purpose of a restraint system is to prevent the worker from being ejected over the guardrail if the mobile scaffold was to hit a pot-hole or other sudden change in elevation while moving.

## 9.9.4 SAFETY OPERATING PROCEDURES FOR PREVENTING AERIAL WORK PLATFORMS FROM TIPPING OVER AND CAUSING FALL MISHAPS

### 9.9.4.1 Safe Use:



- There are hazards associated with using AWP's that can be minimized if the work is accomplished using the appropriate equipment for the specific task and job site.
- The equipment should only be used for the intended application. Never attempt to use the equipment as a crane and never load the platform beyond its maximum rated capacity.
- Operators should park the equipment on level and stable ground and operate it within the design specifications and instruction of the manufacturer.
- Before the equipment is used and during use, the operator should check the work area for possible hazards such as, but not limited to:
  - Trenches, holes or openings, including those concealed by water, ice, mud, etc.
  - Sloping or uneven ground or floor
  - Debris, bump and floor obstructions
  - Wind and weather conditions
  - Inadequate surface and support to withstand all load forces imposed by the machine in all directions
  - Overhead obstructions and electrical conductors
  - Presence of personnel below or in the immediate vicinity
  - Hazardous location and atmospheres

**During use, the operator should maintain:**

- Clear view of the path of travel
- Safe distance from trenches, obstacles, debris, drop-offs, holes, and depressions, ramps, and other hazards to ensure safe travel
- Safe distance from overhead obstacles
- Never move the AWP with occupants in and elevated platform, basket or bucket
- Manually propelled platforms shall not be occupied when moved

Prior to elevating the platform, the operator should verify the access gate or opening is closed per manufacturer's instructions.

Tying off to an adjacent structure or pole is not permitted unless a safe device for 100% tie-off is used for the transfer.

### **9.9.5 Types of Aerial Work Platforms**

July 2017

**Figure 1**  
**Vehicle-Mounted Elevating Work Platform**

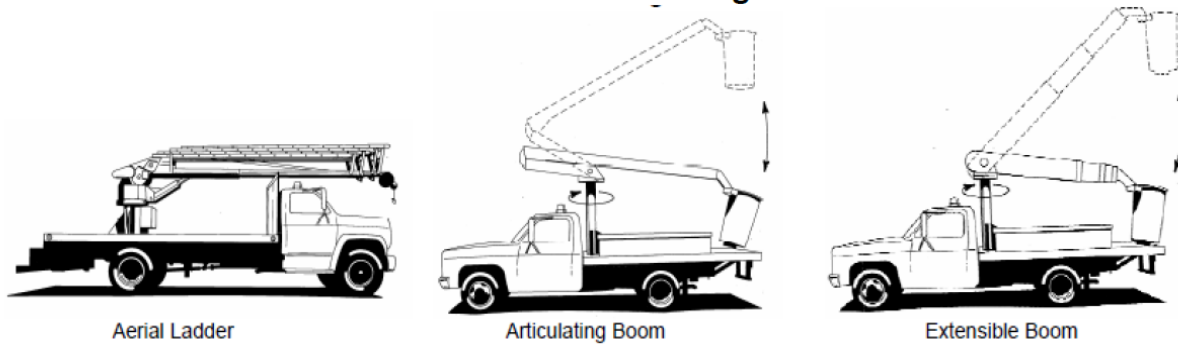

**Figure 2**  
**Manually Propelled Elevating Work Platform**

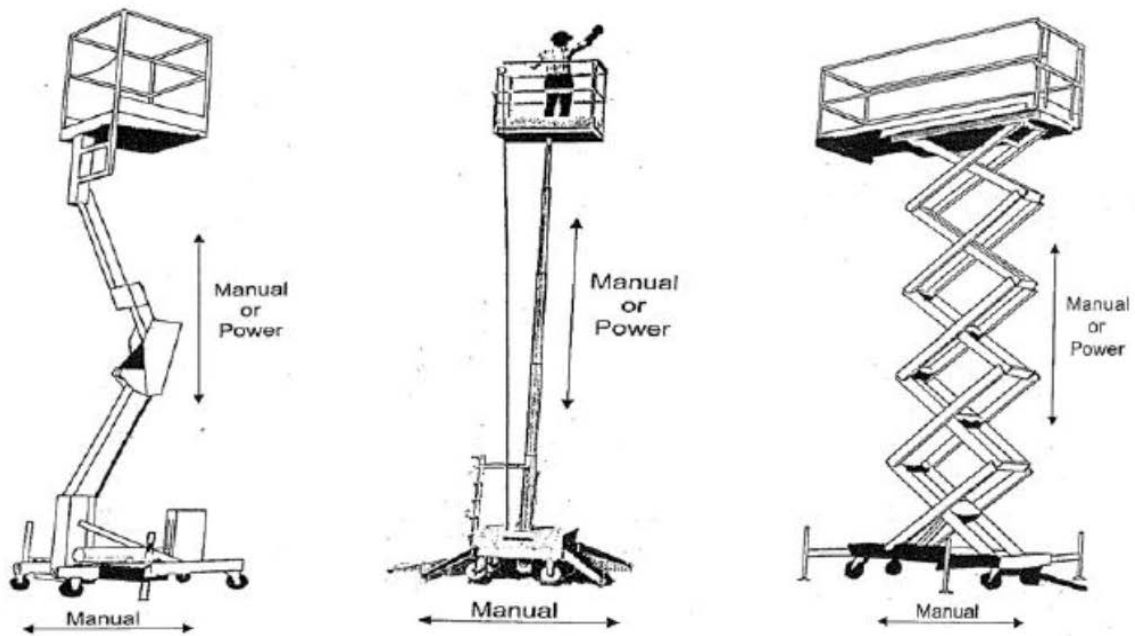

**Figure 3**  
**Boom-Supported Elevating Work Platform**

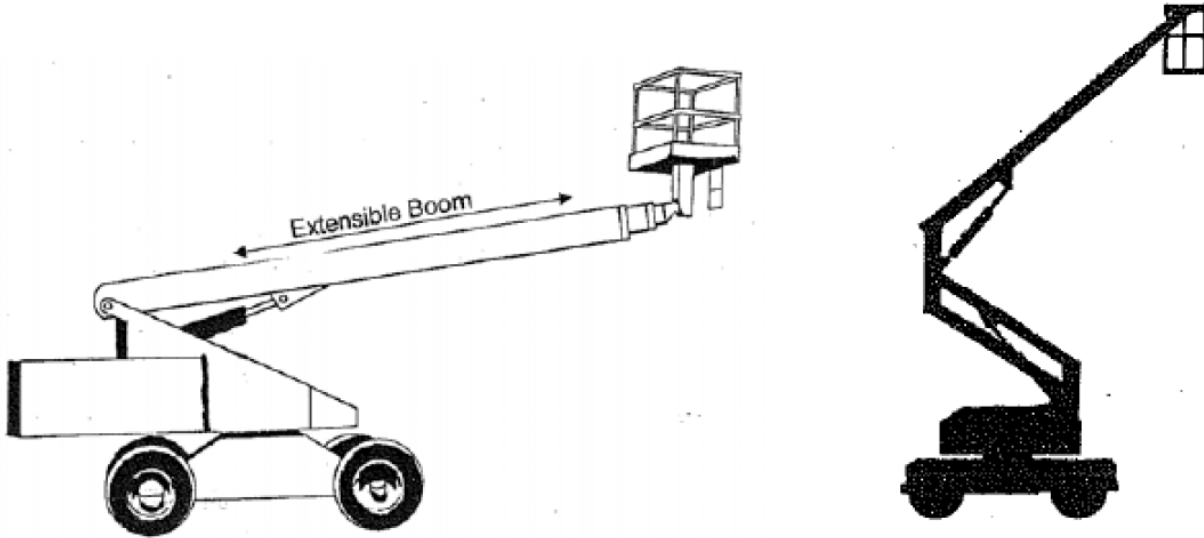

**Figure 4**  
**Self Propelled Elevating Work Platform**

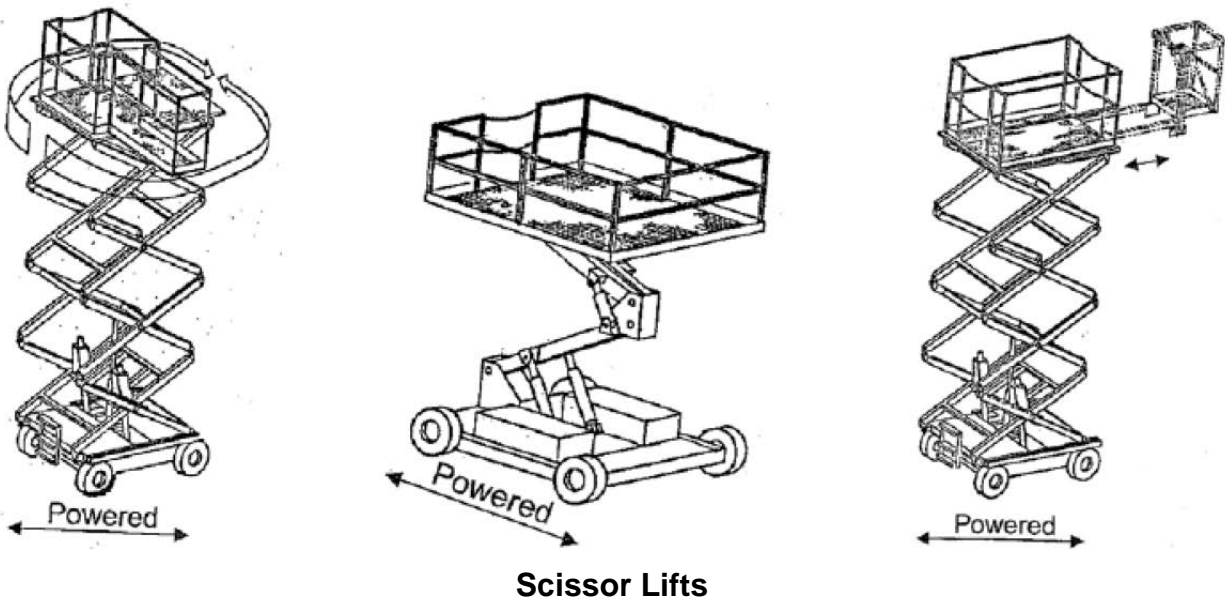

## 9.10 CONFINED SPACE ENTRY

In a confined space, if there should be a hazard of exposure to vertical fall, before entering such a space the person entering shall be tied to a lifeline, SRL, and rescue and retrieval equipment. A co-worker, who is able to retrieve the victim by utilizing the retrieval mechanism from outside the confined space without difficulty, must be present.



**Tripod used for safe entry**

## 9.11 EXCAVATED TRENCHES OR HOLES DEEPER THAN SIX FEET

- Provide temporary guardrails on both sides of the trench, or around holes, or establish a warning line system. Any person crossing this line or guardrails is required to have Fall Protection.
- When persons for the purpose of inspection/testing will be around an excavation that is between 6 feet and 20 feet deep, that has vertical face leading edge fall hazard exposure (sides of the of excavation have not been laid back), or that contains hazards (e.g. impalement hazards, hazardous substances), they shall be protected from falling by the use of a fall protection method.

**Exception:** The designated competent person for excavation may exempt the use of fall protection for inspectors/supervisors provided those individuals are not exposed to fall hazards within 24 inches from the edges, the excavation contains no hazards and the individual(s) stay a minimum of 24 inches from the excavation edge.

## 9.12 SAFE WORK PRACTICES ON LADDERS AND STAIRWAYS

### 9.12.1 Portable and Fixed Ladders

**(a) Application.** Ensure that each ladder used meets the requirements of this section. This section covers all ladders, except when the ladder is:

- (1) Used in emergency operations such as firefighting, rescue, and tactical law enforcement operations, or training for these operations; or
- (2) Designed into or is an integral part of machines or equipment.

**(b) General Requirements for All Ladders.** Ensure the following:

- (1) Ladder rungs, steps, and cleats are parallel, level, and uniformly spaced when the ladder is in position for use;
- (2) Ladder rungs, steps, and cleats are spaced not less than 10 inches and not more than 14 inches apart, as measured between the centerlines of the rungs, cleats, and steps, except that:
  - (i) Ladder rungs and steps in elevator shafts must be spaced not less than 6 inches apart and not more than 16.5 inches apart, as measured along the ladder side rails; and
  - (ii) Fixed ladder rungs and steps on telecommunication towers must be spaced not more than 18 inches apart, measured between the centerlines of the rungs or steps;
- (3) Steps on stepstools are spaced not less than 8 inches apart and not more than 12 inches apart, as measured between the centerlines of the steps;
- (4) Ladder rungs, steps, and cleats have a minimum clear width of 11.5 inches on portable ladders and 16 inches (measured before installation of climbing ladder fall arrest system(ladder safety systems) for fixed ladders, except that:
  - (i) The minimum clear width does not apply to ladders with narrow rungs that are not designed to be stepped on, such as those located on the tapered end of orchard ladders and similar ladders;
  - (ii) Rungs and steps of manhole entry ladders that are supported by the manhole opening must have a minimum clear width of 9 inches;
  - (iii) Rungs and steps on rolling ladders used in telecommunication centers must have a minimum clear width of 8 inches; and
  - (iv) Step-stools have a minimum clear width of 10.5 inches;
- (5) Wooden ladders are not coated with any material that may obscure structural defects;
- (6) Metal ladders are made with corrosion-resistant material or protected against corrosion;
- (7) Ladder surfaces are free of puncture and laceration hazards;
- (8) Ladders are used only for the purposes for which they were designed;
- (9) Ladders are inspected before initial use in each work shift, and more frequently as necessary, to identify any visible defects that could cause employee injury;

July 2017

- (10) Any ladder with structural or other defects is immediately tagged “Dangerous: Do Not Use” and removed from service until repaired or replaced;
- (11) Each employee faces the ladder when climbing up or down it;
- (12) Each employee uses at least one hand to grasp the ladder when climbing up and down it; and
- (13) No employee carries any object or load that could cause the employee to lose balance and fall while climbing up or down the ladder.

**(c) Portable Ladders. (Non Self Supporting). The command shall ensure:**

- (1) Rungs and steps of portable metal ladders are corrugated, knurled, dimpled, coated with skid-resistant material, or otherwise treated to minimize the possibility of slipping;
- (2) Each stepladder or combination ladder used in a stepladder mode is equipped with a metal spreader or locking device that securely holds the front and back sections in an open position while the ladder is in use;
- (3) Ladders are not loaded beyond the maximum intended load; the maximum intended load, includes the total load (weight and force) of the employee and all tools, equipment, and materials being carried.
- (4) Ladders are used only on stable and level surfaces unless they are secured or stabilized to prevent accidental displacement;
- (5) No portable single rail ladders are used;
- (6) No ladder is moved, shifted, or extended while an employee is on it;
- (7) Ladders placed in locations such as passageways, doorways, or driveways where they can be displaced by other activities or traffic:
  - (i) Are secured to prevent accidental displacement; or
  - (ii) Are guarded by a temporary barricade, such as a row of traffic cones or caution tape, to keep the activities or traffic away from the ladder;
- (8) The cap (if equipped) and top step of a stepladder are not used as steps;
- (9) Portable ladders used on slippery surfaces are secured and stabilized;
- (10) The top of a non-self-supporting ladder is placed so that both side rails are supported, unless the ladder is equipped with a single support attachment;
- (11) Portable ladders used to gain access to an upper landing surface have side rails that extend at least 3 feet above the upper landing surface
- (12) Ladders and ladder sections are not tied or fastened together to provide added length unless they are specifically designed for such use;
- (13) Ladders are not placed on boxes, barrels, or other unstable bases to obtain additional height.

July 2017

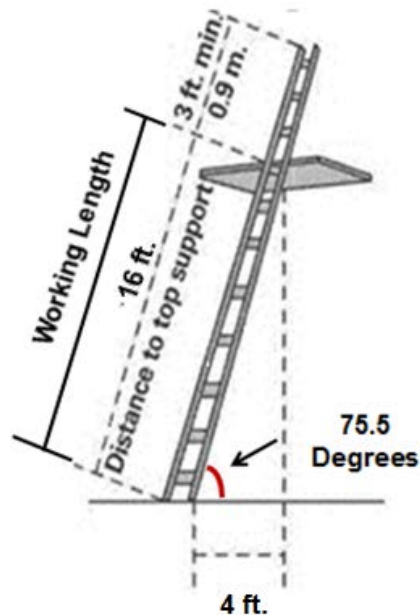

**Correct way of setting Portable ladder**

**(d) Fixed Ladders.** The command shall ensure:

- (1) Fixed ladders are capable of supporting their maximum intended load;
- (2) The minimum perpendicular distance from the centerline of the steps or rungs, or grab bars, or both, to the nearest permanent object in back of the ladder is 7 inches, except for elevator pit ladders, which have a minimum perpendicular distance of 4.5 inches;
- (3) Grab bars do not protrude on the climbing side beyond the rungs of the ladder that they serve;
- (4) The side rails of through or side-step ladders extend 42 inches above the top of the access level or landing platform served by the ladder. For parapet ladders, the access level is:
  - (i) The roof, if the parapet is cut to permit passage through the parapet; or
  - (ii) The top of the parapet, if the parapet is continuous;
- (5) For through ladders, the steps or rungs are omitted from the extensions, and the side rails are flared to provide not less than 24 inches and not more than 30 inches of clearance. When a climbing ladder fall arrest system (ladder safety system) is provided, the maximum clearance between side rails of the extension must not exceed 36 inches;
- (6) For side-step ladders, the side rails, rungs, and steps must be continuous in the extension;
- (7) Grab bars extend 42 inches above the access level or landing platforms served by the ladder;



- (8) The minimum size (cross-section) of grab bars is the same size as the rungs of the ladder.
- (9) When a fixed ladder terminates at a hatch, the hatch cover:
  - (i) Opens with sufficient clearance to provide easy access to or from the ladder; and
  - (ii) Opens at least 70 degrees from horizontal if the hatch is counterbalanced;
- (10) Individual-rung ladders are constructed to prevent the employee's feet from sliding off the ends of the rungs;
- (11) Fixed ladders having a pitch greater than 90 degrees from the horizontal are not used;
- (12) The step-across distance from the centerline of the rungs or steps is:
  - (i) For through ladders, not less than 7 inches and not more than 12 inches to the nearest edge of the structure, building, or equipment accessed from the ladders;
  - (ii) For side-step ladders, not less than 15 inches (38 cm) and not more than 20 inches to the access points of the platform edge;
- (13) Fixed ladders that do not have cages or wells have:
  - (i) A clear width of at least 15 inches on each side of the ladder centerline to the nearest permanent object; and
  - (ii) A minimum perpendicular distance of 30 inches from the centerline of the steps or rungs to the nearest object on the climbing side. When unavoidable obstructions are encountered, the minimum clearance at the obstruction may be reduced to 24 inches, provided deflector plates are installed.
- (14) The entrance of the ladder way to the top level or platform shall be protected by the use of self-closing gate or an offset.
- (15) An employee shall not perform work from a fixed ladder unless he/she is wearing Fall Protection; such as a full-body harness attached to a climbing-ladder fall-arrest system or self-retracting Device which in turn is attached to a properly designed and installed anchorage. If light work is performed from a ladder, use one hand for gripping stability on a rung and the other hand for performing light duty work and by maintaining three points contact at all times (two feet, one hand, or two hands and one foot). When climbing the ladder maintain a three point control by holding on the horizontal rungs with both hands instead of holding on the vertical side rails

July 2017

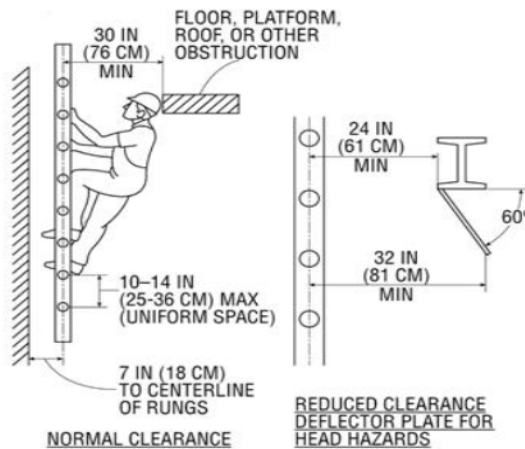

### (e) Requirements for Fixed Ladders Over 20 ft. in Length (Final Rule Changes)

Fixed ladders that extend more than 20 feet above a lower level, the Command shall ensure:

- (1) **Existing fixed ladders.** Each fixed ladder installed before 19 November, 2018 is equipped with a personal fall arrest system, ladder safety system, cage, or well;
- (2) **New fixed ladders.** Each fixed ladder installed on and after 19 November 2018, is equipped with a personal fall arrest system or climbing ladder fall arrest system (ladder safety system);
- (3) **Fixed Ladder Replacement.** When a fixed ladder, cage, or well, or any portion of a section thereof, is replaced, a personal fall arrest system or ladder safety system is installed in at least that section of the fixed ladder, cage, or well where the replacement is located; and
- (4) **Final deadline.** On and after November 18, 2036, all fixed ladders are equipped with a personal fall arrest system or a ladder safety system.

#### Note:

For fixed ladder inspection checklist including requirements, see Appendix H.

## 9.12.2 PORTABLE LADDERS – SELF-SUPPORTING

### (STEP-LADDERS)

- Neither the top of a step-ladder nor the step below the top of the ladder (top step) shall be used as a step, nor used to stand on while performing work.

- Do not use a closed step-ladder as a straight ladder – it may slip out.
- Stepladders shall not exceed 20 feet in length.
- The steps of a step-ladder must be corrugated, knurled, dimpled, coated with skid-resistant material, or treated to minimize slipping.

### 9.12.3 STAIRWAYS

- Stairways having four or more risers, or rising more than 30 inches in height, must have at least one handrail; however, where stairs serve as means of egress, they shall have two handrails. A stair-rail also must be installed along each unprotected side or edge. The top rail of a stair-rail is required to be 42 inches above the walking surface; and stair handrails must be no more than 38 inches or less than 34 inches from the upper surface of the stair-rail to the surface of the tread. The reason for the maximum height of 38 inches is that it is found that people of average height don't grasp handrails higher than 38 inches, because it is not comfortable on their shoulders. **The international Building Code (IBC), the International Fire Code (IFC), and the National Fire Protection Association (NFPA 101) Life Safety Code require the height of new permanent handrails to be 34-38 inches, and 42 inches for permanent stair-rails. Existing handrails may be no less than 30 inches above the nose of stair treads.** The final Rule Requirements for stair rails are identical to IBC and IFC.

• **Permanent Stair Rail: 42 inches high**

• **Permanent Hand Rail: 34-38 inches high**

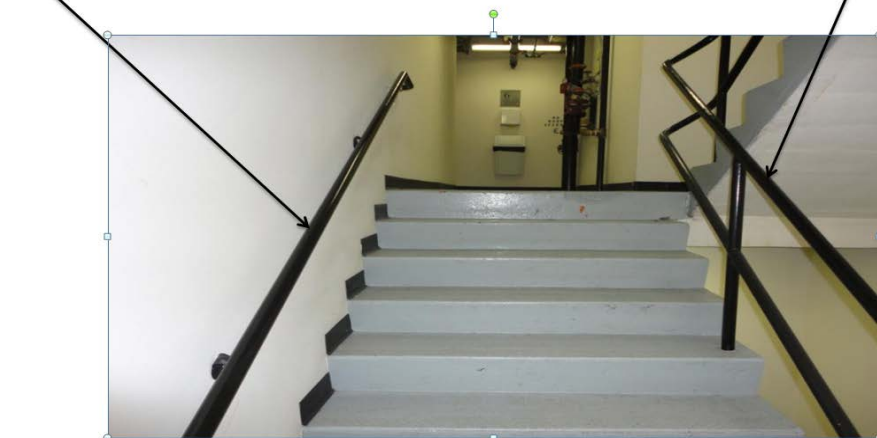

**Industrial Stairs**

- Mid-rails, screens, mesh, or intermediate horizontal members must be provided between the handrail and stairway nosing. In these applications, Intermediate horizontal members, when used, must not be more than 19 inches apart.

- Unprotected sides and edges of stairway landings must be provided with a top-rail 42-inches in height (+/- 3 inches) and horizontal midrail or mid-rails spaced no more than 19 inches apart. . .

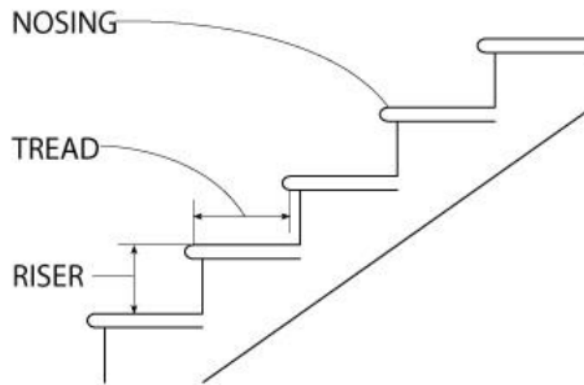

MINIMUM TREAD WIDTH 22 IN (56 CM)  
MINIMUM TREAD DEPTH 9.5 IN (24 CM)  
MAXIMUM RISER HEIGHT 9.5 IN (24 CM)

#### **Standard Stair Dimensions**

### **9.13 WORKING NEAR WALL OPENINGS**

- Wall opening: An opening at least 30 inches high and 18 inches wide, in any wall or partition, through which persons may fall.
- Any time work is performed near a wall or window opening where there *is a Fall-Hazard to a lower level*; Fall Protection must be provided (e.g., guardrail or fall arrest system).

### **9.14 CLIMBING AND WORKING ON WOOD POLES**

- According to OSHA and ASTM F887 standards the requirement for climbing and working on wood poles is to use a body-belt with Wood Pole Fall Restricting Device (WPFRD) which is basically a belt that wraps around the pole. The WPFRD is attached to the two side D-rings of the body belt to facilitate climbing and working on the pole as a positioning system. This is not in compliance with ANSI Z359 FP Code or this Guide because of the use of body belt only and without using a back-up system when working on top of the pole.

- Use a full body harness to facilitate rescue equipped with multiple D-rings (two side D-rings, sternal and dorsal) and a body belt. The two side D-rings are used for attaching the WPFRD to climb the pole.
- When transitioning over the cross arm during climbing and working on the pole, the person can use an adjustable work positioning lanyard for 100% tie off.
- If it is feasible, utilize aerial Work Platforms.
- Personnel shall be trained on rescue



Wood Pole Fall Restriction



Body Belts equipped with either 2 or 4 Side D-rings



Adjustable Rope Lanyard



Adjustable lanyard



FBH with Body Belt

## Wood Pole Climbing Equipment

## 9.14.1 Methods of Inspecting and Testing of Wood Poles

### I. Introduction

When personnel are to perform work on a wood pole, it is important to determine the condition of the pole before employees climb it. The weight of the employee, the weight of equipment to be installed, and other working stresses (such as the removal or re-tensioning of conductors) can lead to the failure of a defective pole or a pole that is not designed to handle the additional stresses. For these reasons, it is essential that, before an employee climbs a wood pole, the employer ascertain that the pole is capable of sustaining the stresses of the work. The determination that the pole is capable of sustaining these stresses includes an inspection of the condition of the pole.

If the pole is determined to be unsafe to climb or to work from, it must be secured so that it does not fail while a worker is on it. The pole can be secured by a line truck boom, by ropes or guys, or by lashing a new pole alongside it. If a new one is lashed alongside the defective pole, employees should work from the new one.

### II. Inspecting Wood Poles

A qualified worker should inspect wood poles for the following conditions:

- A. *General condition.* Buckling at the ground line or an unusual angle with respect to the ground may indicate that the pole has rotted or is broken.
- B. *Cracks.* Horizontal cracks perpendicular to the grain of the wood may weaken the pole. Vertical cracks, although not normally considered to be a sign of a defective pole, can pose a hazard to the climber, and the employee should keep his or her gaffs away from them while climbing.
- C. *Holes.* Hollow spots and woodpecker holes can reduce the strength of a wood pole.
- D. *Shell rot and decay.* Rotting and decay are cutout hazards and possible indications of the age and internal condition of the pole.
- E. *Knots.* One large knot or several smaller ones at the same height on the pole may be evidence of a weak point on the pole.
- F. *Depth of setting.* Evidence of the existence of a former ground line substantially above the existing ground level may be an indication that the pole is no longer buried to a sufficient depth.
- G. *Soil conditions.* Soft, wet, or loose soil around the base of the pole may indicate that the pole will not support any change in stress.
- H. *Burn marks.* Burning from transformer failures or conductor faults could damage the pole so that it cannot withstand changes in mechanical stress.

### III. Testing Wood Poles

The following tests, which are from 1910.268(n)(3), are acceptable methods of testing wood poles:

A. *Hammer test.* Rap the pole sharply with a hammer weighing about 1.4 kg (3 pounds), starting near the ground line and continuing upwards circumferentially around the pole to a height of approximately 1.8 meters (6 feet). The hammer will produce a clear sound and rebound sharply when striking sound wood. Decay pockets will be indicated by a dull sound or a less pronounced hammer rebound. Also, prod the pole as near the ground line as possible using a pole prod or a screwdriver with a blade at least 127 millimeters (5 inches) long. If substantial decay is present, the pole is unsafe.

B. *Rocking test.* Apply a horizontal force to the pole and attempt to rock it back and forth in a direction perpendicular to the line. Exercise caution to avoid causing power lines to swing together. Apply the force to the pole either by pushing it with a pike pole or pulling the pole with a rope. If the pole cracks during the test, it is unsafe.

A properly guyed pole in good condition should, at a minimum, be able to handle the weight of an employee climbing it.

The presence of any of these conditions is an indication that the pole may not be safe to climb or to work from. The employee performing the inspection must be qualified to make a determination as to whether it is safe to perform the work without taking additional precautions.

## 9.15 WORKING OVER WATER

- Employees working 4 feet or more above the water or liquids must be protected from falling by providing Fall Protection (e.g. guardrails, fall-arrest equipment, etc.). Additionally, employees working over or near water, where the danger of drowning exists, also shall wear U.S. Coast Guard-approved lifejackets or buoyant work vests. At least one lifesaving skiff with an available operator shall be present at locations where employees are working over, near, or adjacent to, water that they might fall into. Ring-buoys and a skiff must be provided, irrespective of the Fall Protection provided. Ring-buoys and skiffs address the hazard of falls that may occur in the event of a lapse in use of fall-arrest equipment. Where work over water is performed, a “Man Overboard” plan shall be prepared and used:

### **Additional Requirements:**



July 2017

- When continuous Fall Protection is used without exception to prevent personnel from falling into the water, in this situation, the risk of drowning has been effectively removed and PFDs are not required.
- Where water directly abuts the structure and the distance from walking/working surface to the water is 25 feet or more, personnel shall be protected from falling by the use of Fall Protection system, and PFDs are not required.
- Where the distance from the walking /working surface to the water surface is less than 25 feet and the water depth is less than 10 feet, or hazards from machinery, barges, camels, or other structures fastened to and directly abutting piers, quay walls or wharves, FP is required. Where fall-arrest equipment is used, anchorages must be identified;
- Working from/in machinery (aerial lift equipment, cranes, or other mechanically operated equipment) directly over water, and the depth of water is at least 10 feet, Fall Protection is not required, however, personal floatation devices are required – do not use FP equipment.
- Where certain locations or situations make FP infeasible or impractical, this does not justify such exceptions as the norm throughout.
- If utilizing both PFD and full body harness, the full body harness shall be worn under the PFD. The type of PFD used shall not interfere with proper use of the full body harness and lanyard.

The following is a flow chart explaining when PFD or fall protection is required:

## Flow Chart --FP Requirements for Working Over or Near Water

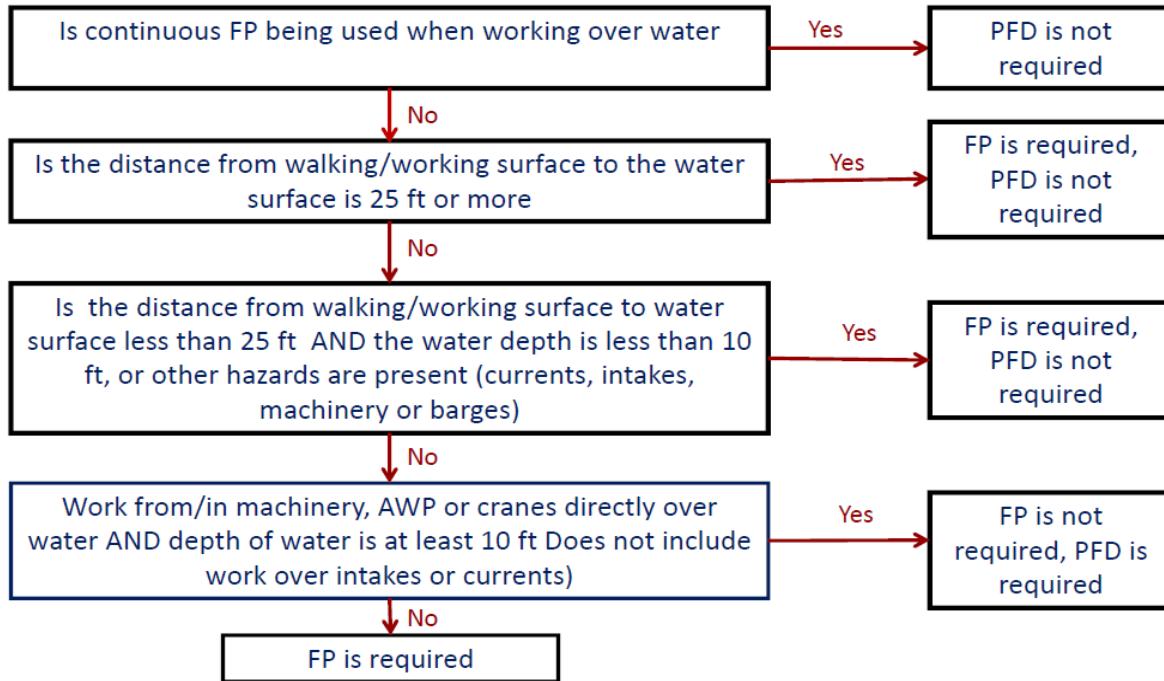

**Note:**

(For Sample Man Overboard Plan, see Appendix D).

### 9.16 AIRCRAFT MAINTENANCE WORK

(SEE CHAPTER 15)

### 9.17 ELEVATED WORK AREA NEAR GUARDRAILS

Wherever an employee climbs above the flooring (e.g., climbs a step ladder placed on a platform) of a lift, catwalk, platform, scaffold, elevated work platform, or stairway above 4 feet (5 feet in shipyard operations and 6 feet performing construction) or working on stilts, thereby reducing the height of the top rail in relation to the employee to less than 42 inches (plus or minus 3 inches), the height of the guardrail must be raised accordingly to maintain a protective height of 42" above the stilt or raised platform/work-stand height. If this is not possible, use another Fall Protection system.

End of Section

## **10.0 GUIDANCE FOR FALL RESCUE PROCEDURES**

### **10.1 INTRODUCTION**

A person is working at heights, using Fall Protection equipment, may require rescue if that person falls and is suspended in a harness. Prompt rescue is very important. Studies show that a person suspended in a harness may have blood circulation problems within a few minutes. Accordingly, a written site-specific “Rescue Plan” must be prepared and maintained for all instances where personnel work at heights and are exposed to Fall-Hazards. The “Rescue Plan” shall contain detailed procedures on the methods of rescue; methods of self-rescue; equipment used; training requirements; specialized training for rescuer(s); procedures for requesting rescue; and available medical assistance. Where the rescue may not be, or cannot be, solely performed by a jurisdictional public (e.g., city fire department) and/or government-emergency response agency (e.g., government fire department), then the “Rescue Plan” must contain detailed procedures for planned rescue methods.

The “Rescue Plan” is a part of the written “Fall Protection and Prevention Plan” and contains provisions for potential self-rescue or assisted rescue of an end-user of Fall Protection. The “Fall Protection and Prevention Plan” covers every Fall-Hazard to which end users are exposed to.

Another important document is the “Pre-Incident Plan”. A “Pre-Incident Plan” is a formal written plan, prepared jointly by the host Navy or Marine Corps activity and the fire emergency responders, containing factors to be evaluated when assessing the potential situations (e.g., fuel storage tanks, energized power cables, hazardous material, Fall-Hazards) that could affect a facility during emergency conditions. The “Pre-Incident Plan” is prepared, reviewed, updated, and approved by a Competent Person for Fall Protection. The Fall Protection Program Manager from the activity reviews and concurs with that portion of the “Pre-Incident Plan” which addresses rescue of a person who has fallen and is suspended in a harness, and incorporates this information into the “Rescue Plan”.

### **10.2 BACKGROUND**

Following a fall from a height, the end-user of Fall Protection who is wearing a full body harness properly secured to an anchorage may be suspended in the harness for a length of time if self-rescue or assisted rescue by co-workers cannot be performed quickly. Sustained immobility in a full body harness may lead to suspension trauma also known as harness-induced pathology as described in reference (a). Suspension trauma resulting from the accumulation of blood in the veins is commonly called venous pooling. The symptoms (known as orthostatic intolerance) of suspension trauma include light-headedness, dizziness, weakness, and occasionally, fainting.

Normally, when an individual faints and collapses onto a flat surface, the pooled blood now no longer is being held down by gravity, and returns to the heart, where it is once again distributed to the body. Assuming no injuries are caused during the collapse, the individual will quickly regain consciousness, and recovery is likely to be rapid.

When an individual hangs in a harness in a vertical or near-vertical position without leg motion, the same thing can happen; however, in this case when consciousness is lost, the person remains vertically suspended. An accumulation of blood in the legs reduces the amount of blood in circulation. After an initial speeding up of the heart-beat, the heart rate then slows, and blood pressure will diminish in the arteries. The reduction in quantity and/or quality (oxygen content) of blood flowing to the brain leads to unconsciousness and harmful effects on other vital organs. If these conditions continue, they potentially may be fatal.

The importance of a timely rescue of a worker suspended in a harness, or who has become incapacitated due to an injury and/or heart attack, mandates the need for a written rescue plan.

### **10.3 GENERAL REQUIREMENTS**

Before an end-user of Fall Protection is exposed to a Fall-Hazard, and before starting work activities, the Competent Person for Fall Protection and the end-user shall ensure that there are pre-incident plans and rescue plans in place that address the rescue of a person who has fallen and becomes suspended in a harness. If a pre-incident plan is not available, the Competent Person for Fall Protection may work with the base safety office/officer, to obtain information from the jurisdictional public/Government-emergency response agency, including emergency contact phone numbers and rescue capability. They then shall include this information in the rescue plan, along with alternative/supplemental rescue methods required to perform a timely rescue of an end-user suspended in a body harness, or one who is incapacitated at heights for other reasons. End-users of Fall Protection shall be trained in the methods for minimizing the effect or delaying suspension trauma if an end-user is suspended in a body harness and unable to perform a self-rescue and needs to wait to be rescued (e.g., keep legs moving and raise knees to the body, to help prevent the pooling of blood in the legs).

Suspension straps attached to the harness can be used to minimize the effect of suspension trauma while the user is waiting for rescue. A strap for each leg is recommended. All end-users should be trained in the safe use of the straps.

### **10.4 INITIATION OF RESCUE**

End-user using Fall Protection equipment shall have an assigned safety person (spotter), also known as the “buddy system”, who is within visual and aural range of the end-user. The duty of the assigned safety person is to check periodically (at least every 5 minutes) to assure that the end-user has not fallen and become suspended in the harness. The assigned safety person shall have the capability to make quick contact with the jurisdictional public- or

government-emergency response agency; or the end-user (or the team leader of a group of end-users) shall have this capability, in the case of the end-user or team visiting another Navy or Marine Corps activity.

## 10.5 FALL-ARREST RESCUE PLAN AND PROCEDURES

A site-specific rescue plan (for an employee suspended in a full body harness after a fall) shall be prepared in writing by the Navy or Marine Corps activity's Competent Person for Fall Protection. In the case of the end-user or team visiting another Navy or Marine Corps activity, the rescue plan shall include the following:

**a. Pre-incident Planning.** Per reference (c) (the *NFPA 101 Life Safety Code*), a written pre-incident plan is prepared by the jurisdictional public (e.g., city fire department) and/or government-emergency response agency (e.g., government fire department). As per reference (c): *"Pre-incident planning is ensuring that responding emergency personnel know as much as they can about a facility's construction, occupancy, and fire protection systems before an incident occurs. With this knowledge, the fire department can compare a potential incident at the facility with its available resources and plan the department's response accordingly. Pre-incident planning is not restricted to building components. It includes other factors and conditions that may be relevant to an emergency at a particular site."* The end-user (or team leader of a group of end-users, in the case of the end-user or team visiting from another activity) in consultation and coordination with the competent Person for Fall Protection shall verify that rescue procedures are in place for any workplace where the authorized rescuer will perform a rescue. The types of Fall Protection systems being used and the work environment shall be reviewed with the jurisdictional public and Government-emergency response agency. The pre-incident plan shall be reviewed and updated by the Navy or Marine Corps activity's Competent Person for Fall Protection annually, or whenever there is a change to the job-site that will affect items in the plan.

### **b. Methods of Rescue.**

(1) Jurisdictional Public Emergency-Response Agency.

(2) Government Emergency-Response Agency.

(3) Assisted Rescue: The written rescue plan shall include instructions for contacting rescue personnel, plus a description and verified location of all equipment to be used by the rescue team (e.g., scissor lift or aerial lift), and complete instructions and procedures for performing rescue safely and promptly.

(4) Self-rescue. An end-user who has fallen and is suspended in a fully body harness and not incapacitated (e.g. an injury, stroke or heart attack), can usually perform a self-rescue, where the following conditions exist:

- (a) The end-user can reach an adjoining structure, and has the strength and mobility to pull up and onto the structure.
- (b) The end-user has a self-deploying or manual-deploying coiled webbing rescue ladder attached to lanyard anchorage, which after a fall allows climbing up to the anchorage point (or at least simply standing on the ladder, allowing the necessary circulation of blood to the entire body while an assisted rescue is being commenced).
- (c) An “automatic or manual controlled descent device” can be used as a self-rescue device if it is attached to a separate anchorage point (minimum 3,000 -pounds strength) and a vertical tag-line is attached to the controlled descent device’s safety snaphook which can be reached by the employee suspended in the full-body harness. The tag-line is pulled, bringing down the self-retracting lanyard from the controlled descent device, and the descent device safety snap is attached either to the back “D” ring or front rescue “D” ring of the fully body harness, and the deployed shock absorber lanyard detached (this method is only viable if there is a “quick release” device which will allow the disconnecting of the shock absorber lanyard under tension). Once the deployed energy absorbing lanyard is disconnected from the fully body harness, the controlled descent device will allow the end-user to descend at a controlled rate to a lower level. This method requires “hands-on” training.

## 10.6 RESCUE EQUIPMENT INSPECTION

Inspection of equipment used by the jurisdictional public- and government-emergency response agencies is the responsibility of these agencies. Prior to use, the end-user shall inspect the self-rescue and assisted-rescue equipment to ensure that it is in safe working condition, and has been protected against damage from the weather (e.g., UV, water) and from workplace conditions (e.g., chemical, physical). Annually, a Competent Person for Fall Protection shall verify that the rescue equipment markings and instructions are consistent with ANSI and OSHA Standards, and that the rescue equipment has been maintained in accordance with manufacturer’s instructions.

## 10.7 TRAINING REQUIREMENTS FOR RESCUE

Training is required for self-rescue techniques. All personnel who will work at height utilizing fall protection equipment shall be trained in self-rescue techniques. They shall be trained in these techniques before utilizing Fall Protection equipment and every two years thereafter.

**(a) Specialized Training for the Rescuers.** Training of rescue personnel at jurisdictional public- and government-emergency response agencies are the responsibility of those agencies. For assisted-rescue the authorized rescuers shall be properly trained and shall be proficient at performing a rescue of a person suspended in a harness or who has become incapacitated at heights. The authorized rescuer shall be knowledgeable in the selection, use, storage, and care of all equipment necessary to perform rescue on end-users from all types of Fall Protection equipment. Carefully evaluate hazards associated with rescue

and determine whether or not it is safe to perform rescue. The authorized rescuer shall conduct a site-visit to the work location prior to writing a post-fall-arrest rescue plan. The authorized rescuer shall assign and delineate various responsibilities in the rescue and evacuation of an employee who has become incapacitated at heights and/or who is suspended in a body harness after a fall. Authorized rescuer training shall be conducted once every two years and evaluated at least annually by a Competent rescuer and shall include the following:

- (1) Fall-Hazard recognition, elimination, prevention and control methods.
- (2) Applicable Fall Protection and rescue regulations and standards.
- (3) Understanding and using the “Fall Protection and Prevention Plan”, and the “Rescue Plan”.
- (4) Inspection and maintenance of the equipment including manufacturers’ instructions.
- (5) Proper uses of various rescue equipment.
- (6) Practical applications and drilling scenarios for rescue (Hands-on Training).

## **10.8 PROCEDURES FOR REQUESTING RESCUE AND MEDICAL ASSISTANCE**

The telephone number for jurisdictional public- and government-emergency response agencies is usually 911, or 9-911, depending upon the Navy or Marine Corps activity. If the emergency response number is different, it must be posted and publicized throughout the Navy or Marine Corps activity.

## **10.9 TRANSPORTATION ROUTES TO A MEDICAL FACILITY**

A sketch indicating the route to the nearest medical facility/hospital (a good practice is to highlight the route with a yellow marker) should be included in the fall-arrest rescue plan) and should be posted at the job-site.

## **10.10 ANCHORAGES USED FOR RESCUE**

a. Anchorages selected for rescue systems including control descent devices shall be capable of sustaining static loads applied in the direction permitted by the rescue system of at least 3,000 pounds when designed as a rescue system only. If the anchorage for fall-arrest system is selected as a rescue anchorage, it shall be capable of sustaining 5 times the foreseeable loads (certified rescue anchorages), applied in the directions permitted by the personnel fall-arrest system per attached person.



b. Anchorage connectors used for rescue shall not be attached to anchorages where such attachment would reduce the allowable capacity of the anchorage itself.

c. Anchorage connections shall be stabilized to prevent unwanted movement or disengagement of the rescue systems from the anchorage. The rescue system shall be load-tested before a live load is placed on the system.

d. The anchorage should be located at a point above the rescuer to prevent swing fall.

## 10.11 SELECTIVE RESCUE EQUIPMENT AND SYSTEMS

The following are some of the selective equipment that activities can use to rescue a person incapacitated at heights or has fallen and is suspended in a harness, or can be used to permit a person suspended in a harness to stand and allow the necessary circulation of blood while an assisted rescue is being commenced:

### Self-Rescue and Assisted-Rescue Equipment:

- a. **Evacuation Harness.** Evacuation harness is used only for rescue and shall be designed to fit properly and securely to hold the rescue subject during rescue. The harness shall, at a minimum, provide support for the body around the shoulders and thighs.



- b. **Rescue Lanyard and Rescue Anchorage Connector Components** shall meet ANSI /ASSE Z359.4 Standard.

July 2017



- c. **Self-Retracting Device with Integral Rescue Capability.** Self-retracting devices with integral rescue capability shall meet the requirements of ANSI Z359.4 and ANSI Z359.14, and shall be capable of engaging into the rescue mode of operation at any time. It shall not be possible to stop automatically and hold the load if the rescuer intentionally or unintentionally relinquishes control. The intent of this mode of operation is that the device will not inadvertently change to or from rescue mode. The minimum mechanical advantage offered by the equipment in rescue mode shall be 3:1, neglecting frictional losses.



Self Retracting Lanyards w/Rescue Capability

Self Retracting Lanyard w/Winches for Rescue

- d. **Synthetic Rope Tackle Block.** The rope tackle block shall have a minimum theoretical mechanical advantage of 3:1; and shall have a secondary means to prevent uncontrolled lowering of the worker. The rope used shall be made of synthetic material and shall have strength aging and abrasion resistance characteristics equivalent to or superior to polyamides.

July 2017



e. **Descent Devices.** Descent devices designed for single use shall have a minimum descent energy rating of 30,000 foot-pounds. Descent devices designed for repeated or multiple uses shall have a descent energy rating of not less than 300 foot-pounds. The descent speed for automatic descent control devices shall be not greater than 6.6 feet/second or less than 1.6 feet/second. For manual control devices and or hand operated the descent speed shall not exceed 6.6 feet/second.

f. **Other Rescue Equipment.**



**Rescue Davit System**



**Rescue Y lanyard**



**Rescue lanyard**

## **10.12 REFERENCES RELATED TO RESCUE**

- (a) OSHA Safety and Health Information Bulletin, SHIB 03-24-2004, updated 2011
- (b) OPNAVINST 5100.23 Series, Section 1312, Rescue Procedures
- (c) NFPA 1670 Standard on Operations and Training for Technical Search and Rescue Incidents, 2009 Edition
- (d) ANSI Z359: Fall Protection Code/Standards
- (e) NAVMC DIR 5100.8, Marine Corps Occupational Safety and Health Program Manual

## **10.13 FALL-ARREST RESCUE PLANS**

**The Fall-arrest Rescue Plan should include the following Information as part of the Fall Protection and Prevention Plan:**

- a. Provide a detailed location of the work site, with any information that will help find the location, building number, floor number; etc. Post written directions that can be read over the telephone to an ambulance driver/police/fire department, or their dispatchers, on how to get to the site from the main gate of a facility. Give complete, accurate information to the rescue responder. Post a map at the job-site, and highlight with a yellow marker, the route one should take from the site to the nearest hospital where someone with minor injuries can be treated expeditiously.
- b. Indicate the location of the lift or other equipment that will be used in case of emergency, and the location of the key.
- c. Provide the detailed location of the closest first aid kit. To assure that no time be lost looking for first aid kits during an emergency, post a site map marking the location of the first aid kits.
- d. List emergency telephone numbers. If an emergency rescue is required, call the telephone numbers in the order listed; i.e., 1st, 2nd, and 3rd. Post written directions that can be read over the telephone to an ambulance driver/police/fire department or their dispatchers on how to get to the site from the main gate of the facility. Give complete, accurate information to the rescue responder.
- e. Send an escort to meet the fire department upon arrival at the scene, and help them or the rescuer find the location of the accident.

July 2017

- f. Give the name of the person (the escort designated to meet the fire department upon arrival at the scene) and the back-up person (in case the designated person is injured) responsible to make the phone call in case of emergency.
- g. Indicate names of personnel that may require rescue during the course of performing their jobs.
- h. If self-rescue is used, indicate the type of self-rescue equipment available at the job-site, or which will be utilized during rescue operations.
- i. Indicate the training the rescuer should receive in order to become a qualified rescuer.
- j. Initiate a buddy system when personnel are working at heights and may require rescue. If the buddy system is not feasible, contact the activity to set up a visual or aural contact with the person exposed to Fall-Hazards every 15 minutes.

**End of section**

## 10.14 SAMPLE FALL-ARREST RESCUE PLAN FORM FOR FALL-HAZARD CONTROL

**(Note: Local commands should use the following form format, making sure that they adhere to appropriate local regulations which may apply)**

**Date:**

**Site & Location Identification:**

**Detailed Location:**

**Primary Emergency Phone Number:**

**Type of Phone/Location:**

**Local Phone Line/Outside Line:**

**Secondary Emergency Phone Number:**

**Backup Rescue Lift is Available/Located at:**

**First Aid kit Location(s):**

**Fire Extinguishers locations(s):**

**Nearest Hospital Route and Location:**

**Procedure for requesting rescue and medical assistance:**

---

**Describe Rescue Operation and method:**

---

---

---

---

---

**Type of equipment used (PPE, Ladder, Hoist, etc.)**

**Training requirements:**

**Specialized Training for the rescuers:**

July 2017

**Name of Personnel Requiring Rescue:**

**Self-Rescue Method and Equipment used:**

**For a person climbing alone, the name of the other person at the activity who will make visual or verbal contact with the end-user at least once every 15 minutes to assure that the user has not fallen.**

**Anchorage for rescue:**

**Pre-incident planning with jurisdictional public and Government emergency response agency:**

---

---

---

**Where work over water is planned, prepare a “Man Overboard” plan and attach as part of the rescue plan. (See Appendix D for a Sample Man Overboard Plan).**

**Additional Comments and Requirements:**

---

---

---

**Prepared by:** \_\_\_\_\_

**Approved by:** \_\_\_\_\_

**End of Section**



July 2017

## 10.15 Site-Specific Fall-arrest Rescue Plan (Checklist)

<i>GENERAL INFORMATION</i>			
<b>Activity/Command:</b>		<b>Date:</b>	
<b>Building/Facility #:</b>		<b>Primary and secondary Phone Numbers:</b>	
<b>Detailed Location:</b>		<b>Ladder/Lift Location:</b>	
<b>First Aid Kit Location(s)</b>	1.	<b>Fire Extinguisher Locations:</b>	1.
	2.		2.
	3.		3.
<b>Nearest Medical Facility and Directions:</b>			
<b>Applicable Local Regulations or Requirements</b>			
<b>Procedure for Requesting Rescue</b>	1.		
	2.		
	3.		
	4.		
<b>Describe Rescue Operation and Method:</b>			
<b>Types of Equipment Used (Ladder, Hoist, Aerial Lift, etc.):</b>			
<b>If Self-Rescue or Assisted Rescue is Planned, Describe Equipment to be used</b>			
<b>Specialized Training for the Rescue Team:</b>			
<b>Describe if Additional Anchorages for Rescue are Required:</b>			
<b>Has Rescue Plan Been developed in coordination with Local Emergency Services (essential if relying on them to provide rescue)?</b>			
<b>Is a pre-Incident Plan prepared when the planned Method of Rescue is the Fire Department</b>			
<b>Additional Comments:</b>			
<b>Prepared By:</b>			
<b>Approved By (FPPM):</b>			

**End of Section**

## **11.0 INSPECTION, STORAGE, MAINTENANCE AND CARE PROCEDURES FOR PERSONAL FALL PROTECTION EQUIPMENT**

As stated in 29 CFR 1910 Final Rule, personal fall arrest systems must be regularly inspected. **Any component of the system with significant defects must be removed from service immediately and shall be tagged or marked as unusable or destroyed.** All Fall Protection equipment shall be inspected before each use by the user in accordance with manufacturer's instructions or 3M card whichever is more stringent. Prior to each use inspection means that the fall protection equipment shall be inspected by the end user at least once at the beginning of each eight hour shift in which it is used to verify that it has not sustained any wear or damage that would require its removal from service. The Competent Person shall inspect the equipment at intervals of no more than one year or as prescribed by the manufacturer of the equipment. **Most manufacturers recommend inspection of the equipment to be conducted twice annually by the Competent Person.** Inspection of the equipment by the Competent Person shall be documented and the tag on the equipment shall be checked and dated by the Competent Person on the date of inspection. All components and sub-components of the selected fall-arrest, positioning, and restraint systems shall be compatible.

**As a general rule, always consult equipment manufacturers' instructions and recommendations for use, inspection, care and maintenance procedures.**

**Inspect personal FP equipment for the following defects:**

- (1) **Webbing and ropes (Harnesses, Lanyards, straps, etc.):**
  - **Look for cuts, wear, tears, damaged threads, broken fibers, undue stretching, torn or pulled stitches, frayed edges, mold, alterations, or additions which will affect its efficiency, damage due to deterioration, chemical damage (contact with fire, acids, or corrosives), abrasions, ultraviolet deterioration and missing markings and labels, and any wearing or internal deterioration of the ropes.**
  
- (2) **Hardware (Snap-hooks, Carabiners, Connectors and D-rings):**
  - **Look for distorted hooks or faulty springs, tongues unfitted to the shoulder buckles, loose or damaged mountings, nonfunctional parts; check for signs of excessive wear, crack, corrosion and deformation.**

**Note**

**For Fall Protection Equipment Inspection Checklist see Paragraph 11.3.**

**11.1 SPECIFIC EQUIPMENT INSPECTION****11.1.1 ANCHORAGE SYSTEMS (anchorages and anchorage connectors):**

- a. Inspect each system component or subsystem according to associated manufacturer's instructions.
- b. Observe any abrasions, wear points, damaged threads, or sags in the sling material before use. Inspect cable slings for excessive damage to the steel fibers. Refer to the tags to determine when the sling should be retired.
- c. For synthetic slings and anchor straps inspect all sewing and loops for wear, chemical damage, burn damage, and/or ultraviolet deterioration.
- d. Inspect anchorage connectors for integrity and attachment to solid surfaces.
- e. Inspect the anchorage connector hardware, including, wire rope, D-rings, and O-rings. These items must not be damaged, broken, distorted nor have any sharp edges, burrs, cracks, worn parts, or corrosion.
- f. Inspect the anchorage connector webbing and stitching. The webbing must be free of frayed, cut or broken fibers. Check for tears, abrasions, mold, or discoloration. The webbing must be free of knots, excessive soiling, heavy paint build-up, and rust staining. Check for chemical or heat damage, indicated by brown, discolored, or brittle areas. Check for ultraviolet degradation, indicated by discoloration and the presence of splinters or slivers on the webbing surface. Check for pulled or cut stitches. Broken stitches may be an indication that the anchorage connector has been impact loaded and must be removed from service. All the above factors are known to reduce the strength of the anchorage connector. Damaged or questionable anchorage connectors must be removed from service.
- g. On wire rope models, inspect cable for cuts, kinks, broken wires, bird-caging, corrosion, welding splatter, chemical contact areas, or severely abraded areas. Inspect ferrules for cracks or damage and inspect wire rope for corrosion and broken wires. Damaged or questionable anchorage connectors must be removed from service.
- h. Record the inspection date and results in the inspection log in section 9.0.
- i. If inspection reveals an unsafe or defective condition, remove anchorage connector from service and destroy

**11.1.2 SNAPHOOKS AND CARABINERS**

- a. Inspect on a regular basis and before each use.
- b. Inspect snaphooks and carabiners for any hook, locks and eye distortion.
- c. Verify that there are no cracks, pitted surfaces and eye distortions.
- d. The keeper latch must not be bent, distorted, or obstructed.
- e. Verify that the keeper latch seats into the nose without binding.
- f. Verify that the keeper spring securely closes the keeper latch.
- g. Test the locking mechanism to verify that the keeper latch locks properly.

- h. Verify that the points where the lanyard attaches to the snaphooks are free of defects
- i. Retire snaphooks, carabiners, and all integral components if any discoloration, deformation, cracks, or abrasions are detected.
- j. Retire immediately if the item has sustained any fall, or if the spring is broken and gate is bent, or if the gatekeeper no longer engages the slot cleanly.
- k. Damaged snaphook and carabiners shall be tagged and removed from service and from the inventory list.
- l. Dirty snaphooks and carabiners shall be cleaned with kerosene, WD-40 (or equivalent), or similar solvents, and immersed in boiling water for 30 seconds to remove the cleaning agent. Dry with a soft cloth to ensure that the gate and gatekeeper operate properly.
- m. Ensure that only double-locking-type gates are used.
- n. Snaphooks and Carbiners bearing the markings of ANSI A10.14, ANSI Z359.1 (1992, R199) or ANSI Z359.1 (2007) are not acceptable and they shall be taken out of service.

### 11.1.3 LANYARDS AND ENERGY ABSORBERS

- a. Inspect lanyards put under a slight tension on a regular basis.
- b. Check all components for abrasion, cuts, discoloration, cracks, burns, knots, torn stitching and excessive wear.
- c. Visually inspect the energy absorber for any signs of damage, paying close attention to where the energy absorber attaches to the lanyard.
- d. Wash lanyards and energy absorbers on a regular basis to remove dirt and grit, which can abrade the fibers.
- e. Lanyards and energy absorbers shall have a permanently attached labels indicating the manufacturer's name, serial number or lot number, date of manufacture, maximum elongation (deployment distance), maximum and average arresting force, maximum free-fall distance (6 or 12 foot free fall), and capacity. The lanyards and energy absorbers must also have permanently attached labels that indicate they meet OSHA & ANSI Z359.13 Standard and requirements. Lanyards bearing the markings of ANSI A10.14, ANSI Z359.1 (1992, R199) or ANSI Z359.1 (2007) are not acceptable and they shall be taken out of service.
- f. Use and review manufacturer's logbook provided with the equipment to determine the age of the lanyard and energy absorber.
- g. Lanyards and energy absorbers shall be inspected by the user prior to each use and by a Competent Person other than the user at least once a year.
- h. Check for missing marking and labels.
- i. Maximum usage of a lanyard shall not be more than 5 years, unless the Competent Person for Fall Protection carefully inspects it, review its history of use and storage, and recommends its continued use, once put in service (assuming the new unused lanyard is stored in a climate-controlled location, [i.e., in a plastic bag not exposed to fumes, and in a cool location out of direct sunlight]).

#### **Retire the lanyard:**

- (1) After a hard fall.

- (2) When the shock absorber (even if slightly) is impacted or deployed.
- (3) If the lanyard has been used for any other purpose other than Fall Protection.
- (4) If the equipment show excessive wear, chemical damage, burn damage, and/or ultraviolet deterioration.

#### **11.1.4 FALL-ARRESTOR (ROPE GRAB)**

- a. Inspect regularly.
- b. Check for signs of wear, corrosion, rust, and other anomalies.
- c. If any sign of wear or malfunction is observed, remove the device from service immediately.

#### **11.1.5 SELF-RETRACTING DEVICES**

- a. Inspect before each use for any physical damage.
- b. Inspection by a Competent Person shall be in accordance with the manufacturer's instructions and recommendations. Inspection shall be documented. c. If the Self-retracting Device housing becomes yellow, gathers condensation, or the indicator has been engaged, remove it from service immediately, and return it to the manufacturer for repair and re-certification.
- c. SRDs shall have permanently attached labels indicating that they meet ANSI Z359.14 and OSHA Standards and requirements.
- d. Make sure that all back nuts or rivets are tight
- e. Make sure that the entire length of the nylon strap is free of any cuts, burns, abrasions, kinks, knots, broken stitches, and excessive wear, and retracts freely.
- f. Test the unit by pulling sharply on the lanyard to verify that the locking mechanism is operating correctly.
- g. Self-retracting devices bearing the markings of ANSI A10.14, ANSI Z359.1 (1992, R199) or ANSI Z359.1 (2007) are not acceptable and they shall be taken out of service.

### **ADDITIONAL DISCUSSION**

SRDs should be briefly inspected prior to each use, and more thoroughly inspected by a CP regularly. With specialized training it is possible that a CP can become certified to conduct re-certification and general services. Usually, SRDs are returned to the manufacturer for service and recertification. Any equipment with many movable mechanical components or parts requires specialized inspection. Usually the CP does not have the tools, equipment and/or qualification to conduct such inspection.

In order to determine if the SRD is in good and safe working condition, specialized testing and inspection must be conducted on the SRD. This includes opening the casing, inspecting the inner components of the SRL and the drum containing excess spooled line, inspecting the locking mechanism, spring, connecting means, and fall indicator, and corrosion inspection in special environments. This is the why only the manufacturer can inspect and certify the SRD.

July 2017

**SRDs are designated as Repairable or Non-repairable:**

**Repairable Self-retracting Devices shall be returned to the manufacturer for servicing and re-certification (Factory authorized inspection) depending on the type, usage and the environment, in accordance with the following Inspection Requirements table:**

TYPE OF USE	APPLICATION EXAMPLES	CONDITION OF USE	INSPECTION FREQUENCY BY COMPETENT PERSON	FACTORY AUTHORIZED INSPECTION
Infrequent to light use	Used in rescue, confined space, industrial (factory) maintenance	Good Storage conditions, indoor or infrequent outdoor use, room temperature, clean environments	Annually	At least every 2-5 years, but no longer than interval required by the manufacturer
Moderate to Heavy Use	Transportation Facilities, Residential/wood Construction, Utilities and Warehouses/Hangars	Fair storage Conditions, indoor and extended outdoor use, all temperature, clean or dusty environments	Semi Annually To annually	At least every 1-2 years, but no longer than interval required by the manufacturer
Severe conditions Continuous usage to	Commercial, Construction and industrial use, Shipyard environment	Harsh storage conditions, prolonged or continuous outdoor use, all temperatures, dirty environment	Quarterly to semi annually	At least annually, but no longer than intervals required by the manufacturer

**All Factory Authorized Inspections of all Self-retracting Devices shall not be longer than the intervals required by the manufacturer.**

**SRDS can either be repaired by the manufacturer or cannot be repaired. For repairable SRDs, not requiring factory authorized inspections by a manufacturer would be considered a non-compliant with ANSI Z359 standards.**

**Non Repairable SRDs are designed and designated as Non-Repairable (not designed for disassembly). They are very basic in design and limited in length and use, made of synthetic webbing. Complete internal inspection is not possible without destroying or damaging the device. The competent person for fall protection shall work with written manufacturer's inspection requirements to determine whether the device can be used or not. If the inspection is not possible, the device shall be taken out of service. The contrast of the device being used inside or outside would affect the term of its use dramatically.**

#### **11.1.6 BODY SUPPORT (FULL-BODY HARNESS)**

- a. Inspect daily or before each use.
- b. Inspect thoroughly and verify that there are no torn, frayed, broken fibers, pulled stitches, or frayed edges, anywhere on the harness
- c. Closely examine all of the nylon webbing to ensure there are no burn marks from welding or heat sources, which could weaken the material
- d. Examine D-ring for excessive wear, deterioration, or cracks.
- e. Verify that buckles are not deformed, cracked, and will operate correctly.
- f. Check to see that all grommets (if present) are secure and not deformed from abuse or a fall.
- g. Check tongue/straps for excessive wear from repeated buckling.
- h. All rivets must be tight, not deformed.
- i. Inspect for missing markings and labels.
- j. Ensure that harnesses are not painted or marked.
- k. Examine the harness for discoloration, abrasions and ultraviolet deterioration.
- l. Store harnesses in a cool, dry, and safe environment; ideally in a locked storage area
- m. A Competent Person other than the user shall inspect the harness periodically, or at least once a year.
- n. Wash the harness in a mild soap and rinse multiple times to remove any soap residue, and hang to dry out of direct sunlight in a cool, dry environment.
- o. Maintain a logbook indicating the date of entry into service, the nature of the work performed, washing of the harness, or other relevant details.
- p. Retire harnesses from service after five years from the date put into service (assuming the new unused harness is stored in a climate-controlled environment [i.e., in a plastic bag not exposed to fumes, and in a cool location out of direct sunlight]) unless the Competent Person for Fall Protection carefully inspects it, reviews its history of use and storage, and recommends its continued use.
- q. The body support harness shall have a permanently attached label indicating manufacturer's name, serial number or lot number, date of manufacture, capacity, and that it meets OSHA & ANSI Z359 Fall Protection Code/Standards requirements.
- r. full body harnesses bearing the markings of ANSI A10.14, ANSI Z359.1 (1992, R199) or ANSI Z359.1 (2007) are not acceptable and they shall be taken out of service.



**11.1.7 ROPES (SYNTHETIC FIBERS)**

- a. Inspect rope periodically for broken fibers, severely worn areas, or change in the consistency of the core; inspect under slight tension and check for soft areas, bulges, or excessive stiffness.
- b. Avoid exposing rope to hazardous chemicals, moisture, acids, or oils.
- c. Do not use the rope after it is impacted or damaged.
- d. Wash the rope on a regular basis with lukewarm water and mild detergent to remove dirt or grit, rinse several times to remove soap residue, and hang in a dry, cool, dark area.
- e. Store rope in a strong weatherproof bag. Rope always must be dry before being placed in storage.
- f. Rope shall have a permanently attached label indicating manufacturer's name, serial number or lot number, date of manufacture, capacity, and that it meets OSHA & ANSI Z359 Fall Protection Code/Standards requirements.
- g. Retire rope after five years of service unless the Competent Person for Fall Protection carefully inspects it, reviews its history of use and storage, and recommends its continued use. If it is damaged, impacted, or exposed to chemicals, remove from service immediately.
- h. Avoid the use of Kern-mantle ropes.

**11.1.8 SINGLE ANCHOR VERTICAL LIFELINES (FLEXIBLE)**

Refer to section 11.1.7 above and manufacturer's recommendations regarding inspection, care, and maintenance of ropes.

**11.1.9 CLIMBING LADDER FALL ARREST SYSTEM**

- a. Inspect on a regular basis per equipment manufacturer's requirements.
- b. The sleeve must run freely without hand operations or guidance.
- c. Check cable and rails for abrasions, wear, looseness, and cracks.
- d. Before climbing, check integrity of cable, system, and ground level.

**11.1.10 RAISING/LOWERING DEVICES (RESCUE)**

- a. Inspect before each use.
- b. Check for wear and corrosion.

**11.1.11 HORIZONTAL LIFELINE**

- a. Inspect the system including anchorages, anchorage connectors, cable and other hardware for defects or loose components similar to inspection of other fall-arrest system components.

The end-user shall inspect the components of the system prior to each use. **Type 1 HLL system**, the Competent Person for Fall Protection shall inspect the system at an interval of no more than one year under the direction of a Qualified Person for Fall Protection. **Type 2 HLL System** shall be inspected once a year by the Competent

July 2017

Person for Fall Protection who is trained by the manufacturer of the system to perform such inspections and under the direction of the Qualified Person for Fall Protection.

## **11.2 ADDITIONAL INSTRUCTIONS FOR ASSEMBLY, DISASSEMBLY, STORAGE, INSPECTION, CARE AND MAINTENANCE**

(a) Protect against cuts and abrasions:

All safety lines and lanyards shall be protected against cuts or abrasions. Padding must be used wherever sharp edges exist.

(b) All safety lines and lanyards shall be stored in an approved location, as follows:

All Personal Fall Protection equipment shall be stored in a weatherproof container or locker when not in use. Equipment should not be allowed to lie in water or direct sunlight, since this will affect equipment strength. Never store personal fall-arrest equipment in the bottom of a tool box, on the ground, or outside exposed to the elements (i.e., sun, rain, snow, etc.).

(c) The fall-arrest system components shall be compatible, as follows:

Contact the qualified or Competent Persons for Fall Protection or manufacturer's representative for assistance. In the use of fall-arrest systems, all components shall be designed for use with each other, or approval must be obtained from the manufacturer or Qualified Person to use the configuration that uses different components. All system components shall be compatible.

(d) Follow the manufacturers and the Qualified Person's instructions for installation, assembly/disassembly, and use, as follows:

All systems must be installed, assembled, and disassembled per the manufacturer's direction. Failure to follow these instructions could lead to the possible failure of a system.

(e) In the event of a fall, secure all equipment involved and contact the Safety Officer for disposition. Do not reuse safety equipment that has experienced a fall:

In the event of a fall, the first response is to ensure the safety of the employees. After rescue and, if required, medical aid is provided, all equipment involved must be removed from service. The Navy or Marine Corps activity Safety Office must be contacted.

For Fall Protection equipment inspection check list and system check list, see Paragraph 11.3.

July 2017

(f) During inspection of the equipment by the competent person for fall protection, only mark on the labels. Some manufacturers permit marking on straps using certain types of permanent markers which are water resistant and quick-drying such as Sanford Sharpie Permanent Markers. Always consult the manufacturer for marking on the equipment

(g) Care and Maintenance of the Equipment:

**Snaphooks and Carabiners:** Clean dirty gates of snaphooks and carabiners by applying WD-40 (or equivalent), other solvents, oil, or kerosene, until the gates work smoothly, then immerse in boiling water for 20-30 seconds to remove cleaning agent; dry with a soft cloth to ensure that the gate and gatekeeper operate properly.

**Harnesses, Lanyards and Ropes:** Wash on regular basis with mild soap and rinse multiple times to remove the soap residue, store in a cool dry and safe environment to dry. Ensure harnesses and lanyards are not painted or marked. Mark only on labels.

**Note**

**Always consult manufacturer's instructions and recommendations for care and maintenance of the equipment.**

**End of Section**

**11.3 FALL PROTECTION EQUIPMENT INSPECTION CHECKLIST**

<b>Activity/Command:</b>								<b>Page 1</b>		
<b>Inspected by:</b> _____ (Competent Person's Name)						<b>Date:</b>				
<b>Work Area:</b>						<b>Department/Code:</b>				
<ol style="list-style-type: none"> <li><b>1. Instructions:</b></li> <li><b>2. All parts of the Fall Protection system and components are to be checked for excessive wear and damage.</b></li> <li><b>3. Use the symbol "Y" for yes or OK.</b></li> <li><b>4. Use the symbol "N" for no or replace.</b></li> <li><b>5. All equipment must be inspected visually before each use by the end-user and by the Competent Person at least annually with documentation.</b></li> </ol>										
Name or Equip #	Self-Retracting Devices		Lanyards		Full-Body Harnesses			Horizontal Lifeline System		
	Cable	Mechanism	Webbing	Energy Absorber	Webbing	"D" Rings and Connectors	Labeling	Anchorage Connection/ Stanchions	Cable	Hardware

### 11.3 FALL PROTECTION EQUIPMENT INSPECTION CHECKLIST (continued)

<b>Activity/Command:</b>						<b>Page 2</b>				
<b>Inspected by:</b> _____ <b>(Competent Person's Name)</b>						<b>Date:</b>				
<b>Work Area:</b>						<b>Department:</b>				
Name or Equip. #	Single Anchor Vertical Lifelines		Anchorages/ Anchorage Connectors		Climbing Ladder Fall Arrest Systems			Snaphooks/Carabiners		
	Rope/cable	Rope Grabs	Structural Integrity	Anchor Strap, Beam Wall and Roof Anchors	Cable/ Rope/ Rail	Rope Grab	Connections	Gate Locking Mechanism	Any Cracks	Deformation

**End of section**

## 11.4 FALL-ARREST SYSTEM AND EQUIPMENT CHECKLIST

(Must answer yes to all applicable questions)

This checklist shall be completed either by the Competent Person or a person trained and designated by the Competent Person for Fall Protection as fall protection equipment inspector.

### 11.4.1 ANCHORAGES

1. Do workers know appropriate anchorage points for each task that requires a fall-arrest/positioning or restraint system? \_\_\_\_\_
2. Are all anchorage points stable, substantial, and have sufficient strength to withstand twice the potential impact energy of the free-fall? \_\_\_\_\_
3. Is the "D" ring of the full-body harness located at the upper back between the shoulder blades? \_\_\_\_\_
4. Are anchorage points for self-retracting lanyards located overhead? \_\_\_\_\_
5. Can the employee move from one station to another or climb up and down without exposure to a fall? \_\_\_\_\_
6. If the lifeline, lanyard, or self-retracting device is not permanently attached to an anchorage point at the elevated work area, is the first worker up or the last worker down protected while climbing and traversing? \_\_\_\_\_

### 11.4.2 LANYARDS

1. Is the lanyard length used in fall arrest as short as necessary and in no case greater than 6 ft.?
2. Are manually adjustable lanyards used when it is desirable to be able to take slack out of the lanyard? \_\_\_\_\_
3. Does the lanyard used in fall arrest have a shock-absorbing feature to limit the arresting forces? \_\_\_\_\_
4. If the lanyard has a shock absorber, is it obvious to the user that the shock absorber has been deployed? (Is there a warning label, broken pouch, deployment indicator, etc.)  
\_\_\_\_\_

5. Are knots from the lanyard to the lifeline clearly prohibited? (Mechanical rope grabs or fall-arresters must be used) \_\_\_\_\_

### **11.4.3 SELF-RETRACTING DEVICES (SRDs)**

1. Are employees properly trained to the use of SRD? \_\_\_\_\_
2. Is the SRD under a regular maintenance and inspection program? \_\_\_\_\_
3. Is the end of the cable properly spliced \_\_\_\_\_ (Thimble eye, Flemish eye-spliced, and swaged fitting/ferrule)?

### **11.4.4 SNAPHOOKS**

1. Have double-locking snaphooks been used? \_\_\_\_\_
2. Is the snaphook attached to the D-ring, designed for the applications, or other hardware in a manner approved by the manufacturer of the snaphook? \_\_\_\_\_
3. Are snaphooks inspected regularly for stress, wear, distortion, and spring failure? \_\_\_\_\_
4. Are snaphooks arranged so they are never connected to each other? \_\_\_\_\_ (They should NOT be connected to each other).
5. Is the strength of the snaphook's gate stamped with the number 3,600 lbs.?

### **11.4.5 FULL-BODY HARNESSSES**

1. Are full-body harnesses selected for a particular job equipped with all necessary attachment points? (For harnesses used in fall-arrest, positioning, restraint, descent control, rescue, or climbing ladder fall-protection systems) \_\_\_\_\_
2. Are full body harnesses inspected regularly for wear, abrasion, broken stitching, and missing hardware? \_\_\_\_\_
3. Is the Velcro type of closure prohibited from all load-bearing connections? \_\_\_\_\_
4. Have workers been instructed in the use and care of full body harnesses? \_\_\_\_\_



5. Is the full body harness equipped with at least one lanyard parking location for attaching the unused leg of the “Y” lanyard? \_\_\_\_\_
6. Is the harness used equipped with fall arrest indicator at the dorsal D-ring?

#### **11.4.6 FALL-ARRESTERS**

1. Is the fall-arrester compatible with the lifeline on which it is to be installed or operated?  
\_\_\_\_\_
2. Is the fall-arrester in operational condition? \_\_\_\_\_
3. Is the fall-arrester equipped with a changeover lever that allows it to become a stationary anchor on the lifeline? \_\_\_\_\_
4. Is the fall-arrester equipped with a locking mechanism that prevents unintentional opening of the device and subsequent disengagement from the lifeline? \_\_\_\_\_
5. Is the fall-arrester’s “up” direction marked properly so that the equipment can be attached to the line correctly? \_\_\_\_\_
6. Is the fall arrester used with single anchor vertical lifeline or climbing ladder fall arrest system the automatic type? \_\_\_\_\_
7. Is the fall arrester used in positioning or restraint system the manual type (Rope adjuster)?  
\_\_\_\_\_

#### **11.4.7 SINGLE ANCHOR VERTICAL LIFELINES**

1. Does the lifeline have a minimum breaking strength of 5,000 pounds? \_\_\_\_\_
2. Is the lifeline protected from abrasive or cutting edges by using chaffing material?  
\_\_\_\_\_
3. Does the system provide Fall Protection as the worker connects to and releases from the lifeline? \_\_\_\_\_
4. Is the lifeline arranged so workers never have to hold it for balance? (A lifeline should never be used for balance) \_\_\_\_\_
5. Is the vertical segment integrated with the horizontal segment to provide continuous Fall Protection? \_\_\_\_\_

6. Is the fall arrestor used with single anchor vertical lifeline equipped with energy absorber and lanyard? \_\_\_\_\_
7. Is the fall arrestor used with single anchor lifeline automatic? \_\_\_\_\_

### **11.4.8 HORIZONTAL LIFELINES**

1. Has the entire horizontal lifeline system been designed, approved and certified by a Qualified Person for Fall Protection? \_\_\_\_\_
2. Have the anchorages to which the lifeline is attached been designed by a professional engineer and evaluated specifically for a horizontal lifeline system? \_\_\_\_\_
3. Has the designer of the system approved the number of employees who will be using it? \_\_\_\_\_
4. Is the rope or cable free from signs of wear or abrasion? \_\_\_\_\_
5. Does the rope or cable have the required initial sag? \_\_\_\_\_
6. Have the workers been warned about potential falls? \_\_\_\_\_  
Have the clearances been checked? \_\_\_\_\_
7. Is the hardware riding on the horizontal lifeline made of steel? (Aluminum is not permitted because it wears excessively) \_\_\_\_\_
8. Is the energy absorber, tensioner, turnbuckles and mobile attachment Device included in a regular maintenance and inspection program? \_\_\_\_\_

### **11.4.9 OTHER CONSIDERATIONS**

1. Has the free-fall distance been considered, so that a worker will not strike a lower surface or object before the fall is arrested? \_\_\_\_\_
2. Have pendulum-swing Fall-Hazards been eliminated or minimized? \_\_\_\_\_
3. Have safe methods to retrieve fallen workers been planned? \_\_\_\_\_
4. Is all fall-arrest equipment free of potential damage from welding, chemical corrosion, or sandblasts? \_\_\_\_\_
5. Are all components of the system compatible according to the manufacture's instruction? \_\_\_\_\_
6. Have employees been properly trained in the following issues?

July 2017

- Manufacturer's recommendations, restrictions, instructions, and warnings \_\_\_\_\_,
  - Location of appropriate anchorage points and attachment techniques \_\_\_\_\_
  - Are there any problems associated with elongation, deceleration distance, and method of use, inspection, and storage? \_\_\_\_\_
7. Are all regular inspections performed by trained inspectors? \_\_\_\_\_
8. Are the written fall protection and prevention plans and rescue plans maintained and updated? \_\_\_\_\_
9. Has the total fall distance and required clearance been considered? \_\_\_\_\_
10. Has rescue of the worker been considered? \_\_\_\_\_

**End of section**

## **12.0 TIE-OFF CONSIDERATIONS AND SELECTION OF SAFE ANCHORAGES**

**12.1** One of the most important aspects of personal fall-arrest is fully planning the system before it is put in use. Probably the most overlooked component of the fall-arrest system is planning for suitable anchorages. Such planning should ideally be done during the design stage and before a structure or a building is constructed so that anchorages can be incorporated and identified during construction for maximum use later during maintenance work. If needed, properly planned and designed anchorages used during construction work may also be used afterward during maintenance, provided they are installed and properly located for performing the maintenance task.

**12.1.1** The strength of a personal fall-arrest system depends on its subsystems and components, as well as the anchorages and how strongly such a system is attached to the anchorage. Such attachment shall not significantly reduce the strength of the system, including the structural members (e.g., the beams or columns to which it is attached). If a method of attachment is used that will reduce the strength of the system, such component (e.g., beam or column) shall be replaced with a stronger one in order to maintain the appropriate maximum characteristics in compliance with IBC and design criteria documents.

**12.1.2** Lanyards shall not be connected to themselves or to other lanyards unless permitted by the manufacturer.

**12.1.3** Knots shall not be tied in lanyards, lifelines, or anchorage connectors (i.e., anchor straps). Tie-off using a knot in a lanyard, lifelines, or anchorage connectors can reduce the strength by 50% or more.

**12.1.4** Tying a rope lanyard or lifeline around rough or sharp edges such as beams, columns or other surfaces may reduce the strength of the line due to cutting action of the sharp edge. If a line is cut or damaged, it will drastically affect the design reaction of the system during a fall. Such tie-off should be avoided or alternate rigging method should be used. As an alternate, use beam clamp, wire rope, effective padding, or abrasion-resistance strap (chaffing protection) around or over the sharp or rough surfaces.

**12.1.5** The anchorage location should be as high as possible to minimize the free-fall distance and prevent any contact with an obstruction or the ground below if a worker falls. Free-fall distance shall not exceed six feet unless a specially designed lanyard is used that will allow the 12 foot free-fall provided the maximum arresting force does not exceed 1,800 pounds. The anchorage point height shall reflect this restriction.

**12.1.6** Tie-off point(s) shall be located in such a way to minimize the swinging of the worker (pendulum-like motion) that can occur during a fall. The farther away in a horizontal direction a worker moves from a fixed anchorage (tie-off point), the greater the swing angle if a fall occurs. If any obstruction exists in the path of the swing fall, the force generated can be significant. The maximum angle of swing away from the tie-off point should not be more than 15 degrees in either direction.

**12.1.7** The strength of an eyebolt is rated along the axis of the bolt and its strength is greatly reduced if the force is applied at an angle to this axis (out-of- the-plane of the eye). Also, the diameter of the eyebolt should be compatible to snaphook or carabiner attachment. Non-rotating rings should be avoided, since falls rarely occur directly along the axis of the eyebolt. Where possible, rotating rings (swivel rings) with full motion in the three axes should be used to increase the angle with the axis to more than 45 degrees. The ring will then be able to automatically align along the direction of force. Swivel rings used as anchorages in a fall arrest system shall be properly sized. The eyebolt used in the fall protection system shall be forged steel. Effort shall be made to minimize the angle between the axis of the eyebolt and the direction of the pull.

**12.1.8** Attaching two snaphooks to the same anchorage:

- a. Where two employees are planning to use the same anchorage simultaneously by using two snaphooks, the anchorage must be certified and rated for use by two people. Connecting both snaphooks to the anchorage will require the use of additional connector.

**12.1.9** Horizontal lifelines, depending on their geometry and angle of sag, may be subjected to greater loads than the impact load imposed by an attached component. When the angle of sag for the horizontal lifeline is less than 30 degrees, the impact force generated is greatly amplified. For example, with a sag angle of 15 degrees, the force amplification is about 2:1 and at 5 degrees sag, it is about 6:1. Depending on the angle of sag, and the line's elasticity, the strength of the horizontal lifeline and the anchorages to which it is attached should be increased a number of times over that of the lanyard. Extreme care should be taken in considering a horizontal lifeline for multiple tie-off. The reason for this is that in a multiple tie-off to a horizontal lifeline, if one employee falls, the movement of the falling worker may cause other employees to also fall. Horizontal lifeline and anchorage strength should be calculated for each additional employee to be tied-off. For these and other reasons, horizontal lifelines shall only be designed, selected, and certified by Qualified Person for fall protections. Inspection of installed horizontal lifelines and anchors before use is recommended.

The following are some considerations when evaluating horizontal lifeline systems:

- a. Review the design calculations of the system;
- b. Review manufacturer's test data of similar systems

**12.1.10** The anchorage and anchorage connector shall be compatible.

**12.1.11** When tying off to a beam or column, do not attach the anchorage connection to a hole in the beam unless evaluated by a Qualified Person for Fall Protection, because the forces generated by a fall will weaken the beam structure. Do not drill a hole for tying off. This attachment will weaken the beam. The most favorable way to tie-off is to use an anchorage connection to wrap around the beam or column, such as an anchor strap, or use a designed beam clamp.

**12.1.12** Do not tie a knot in the anchorage connection.

**12.1.13** The most favorable location to tie-off to a beam is in the center of the span. This action will distribute the forces evenly at the supports. The closer the tie-off point is to the beam support, the shear-force of a fall on the structure will increase accordingly. However, when tying-off to the beam always consider the hazard of swing fall effect.

**12.1.14** Take into consideration the impact of shear forces at the supports and the bending moment distribution of forces beyond the supports into other structural members.

**12.1.15** In the selection of a point of anchor in a column, take into consideration the effect of all forces due to axial loading and bending stresses.

**12.1.16** Refrain from welding the anchorage connection to the anchorage, unless the welding is performed and certificated annually by a certified welder.

**12.1.17** Where nails are used to install roof anchors, the number, type, and size of nails used to attach the component to a wood structure shall be in accordance with the building code requirements. Verify that the roof anchors are attached to structural members, rather than decking only.

**12.1.18** Always specify the number of end-users that are allowed to attach to a specific anchorage.

**12.1.19** In selection of anchorage location, take into consideration the accessibility and ease of securing or attaching to it (ease of tying off).

**12.1.20** When attaching of the fall-arrest system to a concrete slab, make sure the concrete is strong and thick enough to sustain the static and dynamic loads of the fall forces. The bottom steel reinforcement in the concrete slab is usually under tension. Concrete alone is very weak under tension.

## **12.2 Fall-Arrest System Considerations:**

July 2017

- Prior to selecting a fall arrest system, the following information should be verified and considered:
  - Movement of the worker;
  - Existing obstructions in the worker's path;
  - Location and availability of safe anchorages;
  - Total fall distance, free fall distance and available clearance;
  - Possibility of swing fall hazards;
  - Compatibility of all components of the system;
  - Impact forces;
  - Availability of rescue/self-rescue.

**End of Section**



## **13.0 RESPONSIBILITY FOR DESIGN, INSPECTION, CERTIFICATION, and RE-CERTIFICATION of ANCHORAGES and RE-CERTIFICATION OF ACTIVE FALL PROTECTION SYSTEMS**

Anchorage can be either engineered or improvised. An anchorage system is a combination of anchorage point and anchorage connector(s). Improvised fall-arrest anchorages and anchorage connectors shall withstand a force of 5,000 pounds for every person attached to the system. Positioning anchorages shall withstand a force of 3,000 pounds and restraint anchorages shall withstand a force of 1,000 pounds (Per ANSI Z359.2 standard). Anchorage connectors are usually designed and prefabricated by a manufacturer under the supervision of a Qualified Person, and meet OSHA and ANSI standards. The certification and re-certification of anchorage connectors can be performed by the manufacturer or Qualified Person.

### **13.1 RESPONSIBILITY OF ANCHORAGE IDENTIFICATION, DESIGN, AND CERTIFICATION AND RE-CERTIFICATION OF ACTIVE FP SYSTEM**

- a. Certified anchorages should be designed before use by a registered professional engineer with experience in designing fall-protection systems, and installed by a competent person; or another Qualified Person with appropriate education and experience. If an anchor point from existing structures such as beams, or hoist ring designed for construction applications, is needed, a Qualified Person for Fall Protection should be used to evaluate these anchorages.**
- b. Required fall-arrest system anchorages shall be capable of supporting 5,000 pounds per employee attached; or the required anchorages shall be designed for twice the maximum arrest force as part of a complete fall-arrest system, installed, and used under the supervision of a Qualified Person for Fall Protection.**
- c. A Qualified Person for Fall Protection should be able to calculate the forces generated by arresting a fall; total loading; impact on the structural members the line is attached to; and determine the optimal and safe location where and how to tie-off. The Qualified Person should have the knowledge and be capable of designing, certifying, supervising, approving, and rating the required anchorage and tie-off points.**

**Contact a Qualified Person for Fall Protection for anchorages loading, selection and approval:**

Due to the variability in the structural strength of different materials, before using an anchorage point, a Qualified Person for Fall Protection must be contacted to ensure that the anchorage meets/exceeds regulatory requirements.

**d. For recertification of Active Fall Protection systems, the Qualified Person or the engineer of record shall specify the frequency of re-certification, but not to exceed five years.**

## **13.2 INSPECTION, CERTIFICATION AND RE-CERTIFICATION OF ANCHORAGES**

**a. Inspection:** Fall-arrest, positioning, and restraint equipment shall be inspected by the end user before each use, and by a Competent Person annually, and in accordance with the manufacturer's instructions. Workers are not qualified to inspect anchor points; however, they should be trained to pay special attention to any cracks developing around the anchor points, or if the anchor points are unstable or loose. End-users shall not tie-off to unsafe anchorages and they should bring it to the attention of the Competent Person for Fall Protection if such a situation exists. The manufacturers of the Fall Protection equipment/systems shall indicate in the supplied manufacturer's instructions the methods of inspection and durations. Any components of the system not addressed by the manufacturer's inspection requirements (e.g., anchorages), shall be visually inspected in a manner and frequency specified by the design engineer.

**b. Certification and Re-Certification of Anchorages:** Anchorages should be field-verified by a Qualified Person for Fall Protection. ANSI Z359 Fall Protection Code/Standards addresses certification of anchorage connectors. It does not address certification of anchor points (rigid part of the structure). A registered professional engineer who is trained as a Qualified Person for Fall Protection can certify the structural integrity of the anchor points. Depending on the design, type, location, and the size of the structural member to which the anchorage is connected, the environment and weather conditions dictate how often such anchorages shall be inspected and re-certified by a Professional Engineer or a Qualified Person for Fall Protection.

**c. Recertification of Active Fall Protection System:** The design of FP system shall be thoroughly reviewed by a qualified person. The original design of the system should have indicated the frequency of the recertification criteria. **The period of recertification shall not exceed five years.** Recertification process shall include:

- (1) Review of the original design;
- (2) Any changes in the hazards or tasks performed;
- (3) Changes in regulations or standards;
- (4) Any other factors affecting the system.

**d. Qualification and Verification Testing of Fall Protection Equipment:** Navy or Marine Corps activities shall use personal Fall Protection equipment where manufacturers can

July 2017

**substantiate through Third Party Testing laboratories, Witnessed Testing by a Professional Engineer, or Manufacturer Self-Certification testing, and that the equipment meets the requirements addressed in ANSI Z359 Fall Protection Code/Standards.**

**To ensure conformity of the equipment with Z359 Fall Protection Code/Standards, testing laboratories performing compliance testing on fall protection equipment/products shall be accredited by an outside accreditation bodies, accredited to ISO 17011 Standard titled “General Requirements for Accreditation Bodies Accrediting Conformity Assessment Bodies, and ISO 17025 General Requirements for the Competence of Testing and Calibration Laboratories.**

**End of Section**

## **14.0 FALL PREVENTION CONSIDERATIONS DURING PLANNING AND DESIGN PHASE**

**14.1 INTRODUCTION:** When planning and designing new buildings or facilities, DON planners and designers, including owners/managers of such facilities, are responsible for providing safe design for the protection of all workers and users exposed to the hazards of fall from heights during performance of their work. DON architects and engineers or any other entity planning or designing a building, structure, or facility, including integral assemblies such as weight-handling equipment (cranes, hoists, etc.), have the general duty and responsibility to have a safe design for preventing falls throughout the facility. This duty extends to any person who may be involved in the construction, demolition, modification, renovation, maintenance, or normal work operation of the building, structure, or facility.

a. DON architects and engineers need to be aware that any part of a building, facility, structure, equipment, and integral assemblies such as weight-handling equipment (cranes, hoists, etc.), will on day require maintenance work. If such work is required, prevention and control measures should be incorporated into the design phase to eliminate and prevent the need to work at height with its subsequent exposure to Fall-Hazards.

**b. Architects, engineers, designers, construction managers, superintendents, contractors/subcontractors, and owners of buildings and facilities have a major role and are responsible for creating a safe work environment and being aware of Fall-Hazards. They shall have the proper knowledge and awareness of Fall-Hazards that will be encountered at the workplaces they are designing, constructing, occupying, and operating.**

**c. Fall prevention philosophy for designing new buildings and facilities:** Fall-Hazards should be designed out of new buildings, facilities or structures. When Fall-Hazards cannot be eliminated or prevented, designers should provide alternative remedies such as identification and installation of anchorages (hard points).

Any location or part of a building, structure, facility or equipment will one day require, either, maintenance, remodeling, modification or replacement work. Engineers and architects should design new buildings and facilities with this idea in mind.

**d. Fall Prevention during Design for Engineers and Architects**

Falls from height are a major cause of work related injuries and fatalities. Engineers, architects, designers and planners are responsible for designing safe buildings, facilities, structures and equipment. They should strive to eliminate, minimize or

prevent the hazards of falling at work places. During construction, potential hazards should be identified and preventive measures should be incorporated in the design to assist contractors building the project in a safe manner. Post construction, the facility should protect personnel during normal work operations and help maintenance personnel conduct their work safely and without exposing them to Fall-Hazards.

**e. Applicability of Fall Protection Requirements to Architects and Engineers:**

OPNAVINST 5100.23 Series, Paragraph 1311.b states:” Fall-arrest anchorages in new facilities, buildings and structures. During the design of new facilities, buildings, and structures, Fall-Hazards should be considered and eliminated whenever possible. When elimination of Fall-Hazards is not feasible, the design should include certified and labeled anchorages”. Additionally, the ANSI Z359.2 Standard titled Minimum Requirements for a Comprehensive Managed Fall Protection Program require architects and engineers to include Fall Protection systems in the design of new facilities.

**f. Training:**

Architects and engineers are required to be trained in fall prevention in accordance with OPNAVINST 5100.23 Series, Appendix 13-A, and Section 6.2 of this guide.

**14.2 PLANNING AND DESIGN CONSIDERATIONS:** It is very important at the design and planning phase to give consideration to the prevention of falls, not only during construction, but subsequent use, or maintenance of the building, structure, or facility. Consideration during various phases includes the following:

**a. Construction Phase:**

- (1) Reducing the risk when working at heights (e.g., installation of guardrails to the perimeter structural members prior to erection).
- (2) Reducing the need to work at heights as much as possible by prefabricating modules on the ground before lifting them into position.
- (3) The placement and condition of the access road leading to the building or facility during construction, for example, which would enable a crane to place building material in the most appropriate and accessible location.
- (4) Preparation and/or clearing debris on the ground or floor below the work area. The ground should be compacted and leveled in order to prevent tilting, unstable equipment (e.g., cranes or scissor lifts).
- (5) All trenches or holes at the work site shall be guarded adequately to prevent aerial work platforms or other equipment from falling into such hazards.
- (6) Provision of temporary safety mesh as much as possible to prevent objects from falling down to lower levels.

**b. Maintenance and Occupancy Phase:**

- (1) Safe access to or egress from any work area.
- (2) Provision of permanent guardrails or edge protection such as parapets.
- (3) Selection of material that can withstand a harsh environment. (e.g., special wood planks such as particleboard can weaken due to moisture absorption, thereby not supporting the weight of a worker during a future roofing inspection or maintenance work).
- (4) Use of temporary work platforms whenever possible, such as scaffold, and elevating work platforms.
- (5) Identification and location of services (e.g., location of power lines, water, etc.).
- (6) Location and operations of type of equipment selected and devices used (e.g., using adjustable light fixtures that can be lowered to the ground for replacement).
- (7) Use of fall-arrest systems and devices, including the provision of suitably located temporary or permanent anchor points and field identification of all required anchorage points.
- (8) Provision of safety nets, when required.
- (9) Location of and access to equipment.
- (10) Location of amenities, such as plants, security cameras and flood lights at high locations.
- (11) First aid facilities and trained personnel.

**For complete detailed guidance regarding Design Considerations for Management of Fall-Hazards applicable to construction and maintenance phases, see Appendix “E”**

**14.3 FALL-HAZARD IDENTIFICATION:** DON planners, designers including architects, and engineers should identify any Fall-Hazards that will be encountered by an employee working at heights or using means of access to or egress from a building or facility. In order to assist in identifying Fall-Hazards, special considerations should be given to:

- a. Consultation, communication, and coordination with safety and health professionals.
- b. Knowledge of injuries arising from falls that have occurred at a workplace or at similar workplaces.
- c. Communication with various A/Es and contractors to find out if “at risk” workers are having or are likely to have problems while performing their jobs.
- d. Accidents or near-miss incidents related to falls at the workplace or similar workplaces; review safety web pages for various accidents that occurred at similar workplaces.

- e. Review of relevant fall-protection standards, instructions, regulations, and guidance documents.
- f. Communications with employees of similar facilities to determine what type of risks an employee would face during the performance of their duties.
- g. Conducting a walk through inspection of the facility or similar facilities to become familiar with various risk situations.
- h. Compiling statistical records indicating potentially unsafe work practices.

**14.4 RISK ASSESSMENT:** It is the responsibility of the planner or the designer to assess risk of injury to employees—while the employees are at the workplace during performance of their work— resulting from each hazard that involves falling.

**a. Risk in relation to any injury or harm means the probability of that injury or harm occurring is increased.** If a hazard is identified, the risks associated with such hazard can be assessed. Assessment of risks will help planners, designers, and system safety engineers determine the potential injury and thus help identify methods to reduce risks. The necessary steps in a risk assessment process may include the following:

- (1) Identify the specific hazardous/situation that might occur in a workplace.
- (2) Identify the nature of the decisions to be made about hazards and who is responsible for making these decisions.
- (3) Define and decide how such information needs to be presented to the decision makers.

**b. The required information may include the determination and assessment of the following:**

- (1) Size, height, and layout of a workplace.
- (2) Material handling methods or accessing all material or equipment at different locations of the facility.
- (3) Location and condition of all equipment and/or material used in a workplace.
- (4) The number, type of work, and movement of all employees in a workplace, planned facility, or building.

**14.5 RISK CONTROL:** Planners and designers should consider the means by which risk may be eliminated or reduced. Once risks have been assessed, measures should be taken to control the hazards of falling in accordance with the hierarchy or preferred order of control measures. These range from eliminating the worst hazards to the use of other methods that reduce risks. Specific control measures may include the following:



- a. Plans or designs of new or modifications to existing buildings, structures, or facilities should take fall prevention into consideration.
- b. Evaluate methods or the way jobs can be performed safely to eliminate or reduce the likelihood of a fall.
- c. Organize and schedule work so that employees do not interfere in safety measures taken or increase the risk of a fall for themselves or others
- d. Identify the information and knowledge required by contractors to enable them to work safely at heights.
- e. Collect, assemble, and present the information required to eliminate or reduce hazards.
- f. Identify the training or knowledge requirement to work safely if there is a risk of falling.

#### **14.6 HIERARCHY OF CONTROL MEASURES FOR PLANNING AND DESIGN PHASE**

**Elimination of Fall-Hazards is the preferred control measure. For other control measures See Chapter 7.**

#### **14.7 APPLICABILITY OF UNIFIED FACILITIES GUIDE SPECIFICATIONS (UFGS) TO FALL PROTECTION**

UFGS 01 35 26.05 20 Government Safety Requirement for Design Build, Paragraph 3.4.9 titled Fall Prevention During Design Phase requires the contractor to consider and eliminate fall hazards encountered during the operation and maintenance evolutions of the buildings or facilities. If it is not feasible to eliminate or prevent the need to work at heights with its subsequent exposure to fall hazards, control measures should be included in the design to protect personnel conducting maintenance work after completion of project.

Additionally, UFGS Section 01 33 10.5 20 "Design Submittal Procedures, Request for Proposal, Part 2, requires the contractor to submit Fall Protection Analysis Report, prior to start of the design work. The report shall identify fall hazards in the basis of design with the design development and pre-final submittals. The fall protection analysis report shall describe how fall hazards are considered, eliminated, prevented or controlled to prevent maintenance personnel from exposure to fall hazards while performing work at heights. The design analysis shall be a presentation of facts. The Architects/Engineers – If this is part of the contract, the Design Managers should

July 2017

require the contractor to submit this report for review and acceptance prior to start of the design work.

**End of Section**

## **15.0 GUIDANCE - FALL PROTECTION FOR AIRCRAFT MAINTENANCE AND INSPECTION WORK**

### **15.1 INTRODUCTION**

Falls from aircraft are potential sources of injuries and fatalities to aircraft maintenance personnel, aircrew, and inspectors. This chapter is designed to provide guidance to mitigate these risks and help to ensure the safety of all personnel who perform aviation maintenance and inspection work at the organizational, intermediate, and depot levels.

### **15.2 APPLICABILITY**

This guidance document applies to all Navy and Marine Corps Military and Civilian personnel worldwide involved in aircraft maintenance and inspection work where personnel are exposed to the hazard of falling from heights and/or there is a need for fall protection.

### **15.3 PURPOSE**

The purpose of this Chapter is to provide administrative tools, criteria, and safe work practices to mitigate fall hazards when conducting aircraft maintenance or inspections. Naval Aviation, maintenance, inspection and aircraft wash-downs are considered maintenance tasks under the Naval Aviation Maintenance Program (NAMP).

### **15.4 APPLICABLE STANDARDS, REGULATIONS, SOPS AND INSTRUCTIONS**

OPNAVINST 5100.23 (series) requires fall protection when working 4 feet or more above lower levels to be mitigated by one or more of five hierarchies of control measures. In addition, federal OSHA fall protection regulations apply to civilian personnel at all times. Federal OSHA regulations 29 CFR 1910 also apply to military personnel.

Commander Naval Air Forces Pacific and Atlantic issued coordinated naval message DTG 290027Z Sep 10, 2010 to develop fall protection program requirements and ensure program compliance as part of a Navy wide effort to achieve the DON Safety Vision for 2009 and Beyond and the Secretary of Defense's (SECDEF) 2012 mishap reduction goals. This message was further clarified with CNAF message 201800ZMAR14. The CNAF requirements for developing a fall protection program are taken directly from requirements put forth by Chapter 13 of OPNAVINST 5100.23 Series for developing a comprehensive fall protection program.

### **15.5 WRITTEN FALL PROTECTION PROGRAM**

OPNAVINST 5100.23 Series, Chapter 13, and Chapter 3 of the DON Fall Protection Guide, require all commands to develop a written Fall Protection program. For aviation units; Navy type model wings and Marine Corps air wings (with type model program office assistance)

shall establish a type model series (T/M/S) specific fall protection program, which includes identification and elimination or control of Fall Hazards. This is to be accomplished through a T/M/S specific Fall Hazard Survey and assessment and a T/M/S specific Fall Protection and Prevention Plan. Navy and Marine Corps commands/activities are responsible for: identifying site specific fall hazards relating to their environment/facilities/equipment and providing prevention and control measures for those specific hazards. Each activity is also responsible for assigning responsibilities; training of personnel; inspecting the equipment; auditing and evaluation; proper installation and use of fall protection systems; and the availability of rescue equipment with accompanying rescue procedures. An example of Site specific aspects of a unit's Fall Protection Program that may vary between units/sites.

The command policy should contain three enclosures:

- 1) Enclosure one should be the wing generated, T/M/S specific Fall Hazard Survey.
- 2) Enclosure two should be the wing generated Fall Protection Program Policy.
- 3) Enclosure three should be the site specific command or activity level survey.

The FP guide has a sample written FP program; paragraph 3.2 includes a template that the commands can tailor to their needs.

#### NOTE

The Wing level T/M/S fall hazard survey will be specific to the identified fall hazards associated with the Specific T/M/S aircraft (i.e. MH-60s). The command level fall hazard survey will expound on the Wing survey and include mitigation strategies afforded by the facility occupied by the activity (i.e. MH-60s located in Hangar 103 at MCBH Kaneohe).

## 15.6 DUTIES AND RESPONSIBILITIES

The command Fall Protection Program Manager (FPPM) shall ensure that assigned personnel have the necessary skills, knowledge, training, and expertise to manage, administer, and implement the fall protection program. At a minimum, the command shall have a designated Fall Protection Program Manager. Chapter 4 of the fall protection guide provides additional guidance for positions within the program, including the duties and responsibilities of personnel involved in the fall protection program. The following positions shall be included in the command fall protection program with their required qualifications and responsibilities:

- a) Aviation Squadron Fall Protection Program Manager (AV FPPM). A person assigned designated in writing by the Commanding Officer who is responsible for the development, management and implementation of the Fall Protection Program. The Aviation FPPM shall ensure that personnel exposed to fall hazards and other personnel involved in the program receive adequate training as outlined in 5100.23 chapter 13 and Chapter 6 of this guide. Aviation FPPMs may contact their TYPE WING Safety Offices for information on possible Aviation FPPM training options.

July 2017

NOTE

The AVFPPM responsibilities should be assigned to the Commands Aviation Safety Officer or Ground Safety Officer; however this position may be assigned to an E-6 or above.

b) Exposed Personnel. (Any person exposed to a fall hazard while performing aircraft maintenance and inspections). Exposed personnel shall receive unit level fall protection training from the Aviation FPPM. At a minimum training shall include: stands, ladders, over-wing maintenance and climbing aircraft.

c) End User for Fall Protection Equipment (Authorized Person) (as required) – Shall be trained in the use of Personal Fall Protection Equipment (harnesses and lanyards) by a Competent Persons for Fall Protection. This means any activity utilizing harness and lanyard for direct connect to aircraft, to a portable system, to a system integral to hangar or in a boom lift shall complete this training

d) Competent Person for Fall Protection (as required). A person designated in writing by the Commanding Officer to be responsible for the immediate supervision, implementation and monitoring of the fall protection program; who through training, knowledge and experience is capable of identifying, evaluating and addressing existing and potential fall hazards, and in the application and use of personal fall protection and rescue system or any component thereof, and has the authority to take prompt corrective measures to eliminate or control the hazards of falling.

NOTE

The AVFPCP responsibilities should be assigned to an E-6 or above, preferably a Quality Assurance Representative (QAR).

NOTE

A command designated Competent Person for fall protection is only required at the unit if personnel are using Personal Fall Arrest Systems (i.e. Harnesses and Lanyards)

NOTE

Installation safety offices maintain personnel trained to the Competent Person level and are available to support aviation units by request.

NOTE

With adequate education, training, and experience, the Aviation FPPM may also function as a Qualified Person and/or Competent Person

e) Qualified Person for Fall Protection (as required). A person with a recognized engineering degree or professional certificate and with extensive knowledge, training, and experience in fall protection and rescue field; who is capable of performing design, analysis, and evaluation

of fall protection systems and equipment. A Qualified person is necessary for annual inspection of horizontal lifeline systems.

Qualified personnel from Naval Facilities Engineering Command (NAVFAC) personnel can fulfill this role as required.

**NOTE**

Wings and Squadrons do not need Qualified Persons on staff as a practical matter.

f) Competent Person for Inspection of Fall Protection Equipment (optional) - A person who has been trained by the Competent Person or Qualified Person for fall protection to perform and document inspections of personal fall protection equipment. Personnel trained as Aviation Squadron Fall Protection Program Managers can also perform these inspections.

## **15.7 WORKPLACE SURVEY AND ASSESSMENT OF FALL HAZARDS**

a) Fall Hazard Survey – A Competent Person for Fall Protection or an Aviation Fall Protection Program Manager shall conduct the workplace survey. The workplace survey shall encompass the aircraft and all maintenance areas (i.e. hangars, wash racks, flight line) and different access equipment that may be available in each area. The fall hazard survey shall be validated annually for comparison purposes.

**NOTE**

A Fall Hazard Survey Report shall be site specific, but reports for a particular T/M/S may have already been completed and can serve as a template for alternate sites. Contact your Wing Safety Officer for potential templates.

b) Hazard Assessment – Once fall hazards are identified in the workplace survey, the hazards must be assessed. Mil-STD-882E, OPNAVINST 3500.39 (series), and OPNAVINST 5100.23 series chapter 12 provide matrices to assess hazards based on mishap probability and severity. Considerations such as potential environmental conditions should also be included in each hazard assessment.

c) Fall Hazard Survey Report – Identification and assessment of fall hazards in addition to comprehension of the tasks to be performed by personnel working at heights which will allow the Competent Person for Fall Protection or Program Manager to develop alternatives to mitigate fall hazards. Chapter 5, Section 5.3 of the DON Fall Protection Guide provides guidance for preparing workplace survey reports. The Workplace Survey Report should list all fall hazards (height and hazards for each elevated working platform or area), provide a list of maintenance tasks that may be executed for each elevated working area, and provide a risk assessment for each task. Tasks may be grouped for assessment purposes for each elevated working area if they pose the same risk (i.e., all

tasks associated with the port wing, starboard wing, forward fuselage, aft fuselage). Caution must be applied to grouping tasks that have different risk assessments. For example, applying torque to a main rotor head bolt may present a much greater hazard severity and probability than performing an inspection of the main rotor head despite both tasks being conducted on the same elevated working platform.

**Note:**

**For Sample Fall Hazard Survey and Assessment Report See Appendix I**

## **15.8 TRAINING**

Training of Fall Protection Program Managers, Competent Persons, End-users and Exposed Personnel – Training requirements for all personnel involved in the fall protection program, including personnel who may be exposed to fall hazards when performing aircraft maintenance or inspection work, are addressed in the OPNAVINST 5100.23 (series), Appendix 13-A and paragraph 6.2 of DON Fall Protection Guide.

**NOTE**

The training matrix and requirements in this guide are more up to date than the requirements specified in the OPNAVINST 5100.23.

Per requirement generated by CPF/CNAF the MPHA program offers the following as part of technical assist visits.

Aviation Fall Protection Program Manager Course (2 day)  
Aviation Fall Protection Competent Person/Rescue course (5 day)

The following courses are available via ESAMS:

4437 Fall Protection Program Manager Training (Part 1)  
4438 Fall Protection Program Manager Training (Part 2) and Refresher Training for the Competent and Qualified Persons for Fall Protection  
2018 Navy Fall Protection Awareness Training for End Users Working at Heights and Supervisors of End Users (This course must be combined with hands on training)

Contact your Administrative Chain of Command for possible training alternatives.

## **15.9 FALL PROTECTION SYSTEMS AND EQUIPMENT USED FOR AIRCRAFT MAINTENANCE AND INSPECTION WORK**

Fall protection methodologies, equipment and systems are pieces of the overall hazard analysis and fall protection and prevention plan for an aviation maintenance and/or inspection evolution. Location of the aircraft or potential fall exposure, nature of the task, environmental conditions, work area of the aircraft or working platform, and consideration for other potential



hazards that may be introduced with the use of fall protection methodologies, shall be considered for each task. Consideration must be given to all hazards encountered with the execution of a particular maintenance or inspection task, to determine the best and safest course of action.

The following paragraphs list types of fall protection systems that can be used for aircraft maintenance and inspection, in cases where fall hazards cannot be eliminated. They are listed in accordance with the hierarchy of controls, stated in Chapter 13 of OPNAVINST 5100.23 (series), and Chapter 7 of this guide. For more details on fall protection equipment and systems, see Chapter 8 and 9 of this guide. Navy and Marine Corps activities must determine those fall protection measures which must be taken, based on risk analysis of the work or inspection to be performed:

### **15.9.1 Mobile Work Platforms and Mobile Man Lifts (Prevention, Engineering Controls)**

Where work is performed from elevated work platforms four feet or higher, the work platforms shall be equipped with a standard guardrail and safe method of access, or other fall protection system that mitigates potential fall hazards. Mobile servicing platforms are authorized, but shall be required to provide additional fall protection equipment per the manufacturer's specifications. Work platforms shall comply with OPNAVINST 5100.23 (series), OSHA 29 CFR 1910 and COMNAVAIRFORINST 4790.2 (series).

Mobile Work Platform (MWP) and Mobile Man Lift (MML) provide powered access from self-propelled elevating platforms which are approved as Ground Support Equipment.

#### **15.9.1.1 Mobile Man Lifts (MML)**

The MML was specifically procured for support to MV-22 and E-2Ds but operating range lends itself to support several aircraft of that size.



Mobile Manlift (MML) in non-powered and is authorized a peculiar SE for MV-22 and E-2D



Mobile Manlift (MML) provides tremendous utility as platform has telescopic extension

**WARNING**

**MML is equipped with anchor points. All occupants of MML shall utilize Harness and Lanyards for restraint. Lanyards shall be attached to authorized anchor points IAW MFR instruction and/or NAVAIR Technical Manual**

**15.9.1.2 Mobile Work Platforms (MWP)**

Mobile Work Platforms (MWP) are Ground Support Equipment (GSE) that come in two configurations a diesel and an electric model. The MWP A/S-32M-2 are manufactured by Grove. A replacement MWP is planned for fleet introduction in FY18.



MWP A/S-32M-2 in use on P-3

**WARNING**

**MWP is equipped with anchor points. All occupants of MWP shall utilize Harness and Lanyard for restraint. Lanyards shall be attached to authorized anchor points IAW MFR instruction and/or NAVAIR Technical Manual**

**NOTE**

The A/S-32M-2 MWPs are scheduled to begin replacement during FY21.

**15.9.2 Ground Support Equipment (GSE) (Prevention/Engineering Control)**

GSE includes the B Series stands were designed in the 1950s to provide safe access to a variety of airframes. This includes the B-1, B-2, B-4, B-5, and B-7 stands.



**CAUTION**

**Many of the B-Series stands are not OSHA compliant and provide inadequate fall protection if guardrails are removed or if swing gate across ladder way is not installed.**

**NOTE**

PMA-260 has issued two Technical Directions (TD) for installation of self-closing swing gates on B series stands to make stands OSHA compliant.

The first TD, ISEC 5973 for B-1 stands was supported with procurement of 859 Double swing gates, were delivered to custodians from 2012-2014. The second TD, ISEC 5974, is for B-4 stands and 1401 swing gates were delivered for compliance with TD.



**CAUTION**

**Guardrails on many B-series stand may be removed to facilitate work on the aircraft. When a Guardrail is removed to facilitate work that leading edge shall be placed as close to the aircraft as possible and stand raised to reduce gap to no more than 19 inches to minimize the potential fall exposure.**

**CAUTION**

**Midrails and Top Rails of maintenance stands are not to be used as additional ladder steps**



**CAUTION**

**B-Series stands have a capacity limit clearly marked on side. Do not overload stands with tool boxes and excess personnel.**

**15.9.3 Phase Stands (Prevention, Engineering Control Measures)**

Phase Stands are specific to the T/M/S and many be referenced in maintenance manuals. After market phase stands or modified phase stands should be identified as a special tool in Fall Protection Program. Additionally, a lifecycle plan should be created that includes Maintenance Requirement Cards and Pre-Op Cards.



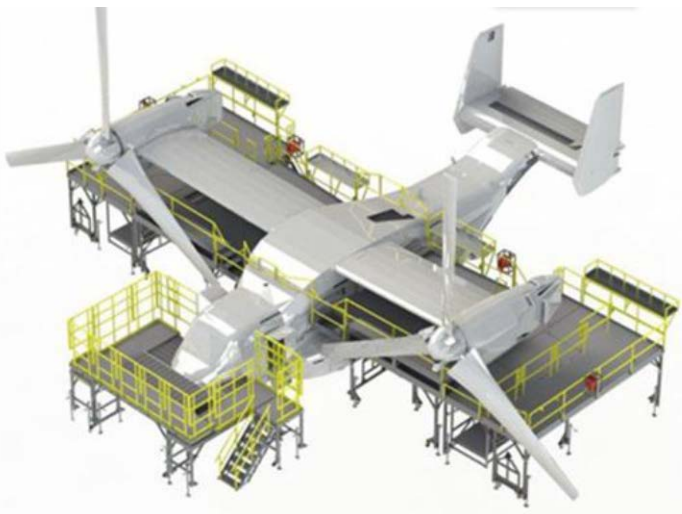

Phase Stand

#### 15.9.4 Warehouse Stands and Scaffolding (Administrative Procedures/Safe Access)

Warehouse stands and scaffolding provide means of access and some level of protection from fall. Scaffolding is more likely at Depot level maintenance facilities. If these stands are used at the Organizational level, stands should be accounted for as a special tool in Tool Control Program. Additionally, a lifecycle plan should be created that includes Maintenance Requirement Cards and Pre-Op Cards.



Warehouse Stand

#### 15.9.5 Ladders (Administrative Procedures)

Ladders - Provide means of access but no means of fall protection. There are three types of ladders that appear in aviation community.

- a. Authorized Aircraft Ladders such as the Little Giant IAA
- b. Ladders that have been authorized a Special Tools such as ones discussed earlier
- c. Unauthorized Ladders

**WARNING**

**Do Not stand on top two steps of self-supporting ladder (A Frame ladder)**



**CAUTION**

**Do not face away from the ladder. Keep ladder perpendicular to work area.**



**15.9.6 Integrated platforms (Working surface/Administrative Control)**

Some aircraft are equipped with areas that are integral to the aircraft and provide a means for maintenance personnel to have a place to work. Additional fall protection may be required. Some examples are:

- d. MV-22 nacelle doors that fold out to provide a working surface
- e. MH-60R/S clam shell doors that allow access to engines
- f. MH-53

**CAUTION**

**Integrated platforms have a capacity rating that should not be exceeded.**



**15.9.7 Integrated steps**

Integrated steps provide access but do not provide protection

**CAUTION**

**Utilize ground spotter when utilizing aircraft boarding ladders such that in the event of a fall they may be able to prevent significant head strike on deck.**



**15.9.8 Air surfaces- Improvised working surfaces**

The vast majority of the work at height that must be performed especially on flight lines is performed atop the wings, fuselage or tail section. Lines of demarcation are in many cases located between the do not step warnings and the nonskid locations.



July 2017



### 15.9.9 Restraint System. (PPE)

A system consisting of equipment and components connected together designed to restrain a person from reaching an exposed fall hazard. Restraint system is also referred to as travel restraint.

#### 15.9.9.1 Integrated Restraint Systems-

Airframes where anchorages are built directly into airframe. Some examples are the MV-22, E-2D and the H-60.

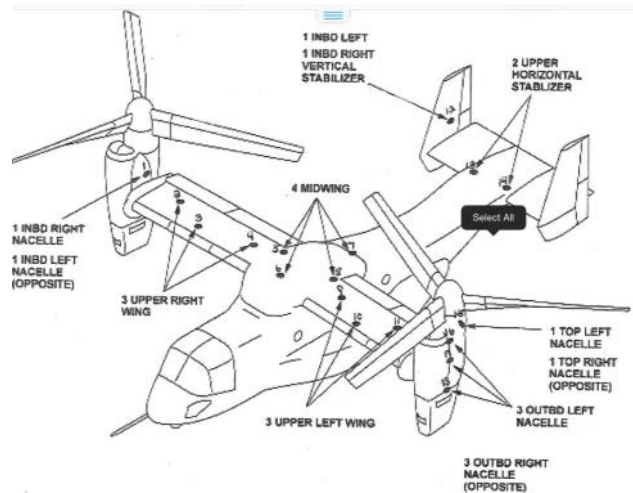

July 2017

USE ONLY THE CABLES APPROPRIATE FOR TASK, i.e. 130 ISO WOULD ATTACH ALL CABLES, WORKING AROUND ENGINES WOULD ONLY REQUIRE SET(S) RUNNING ON THE TRAILING EDGE BETWEEN ENGINES.

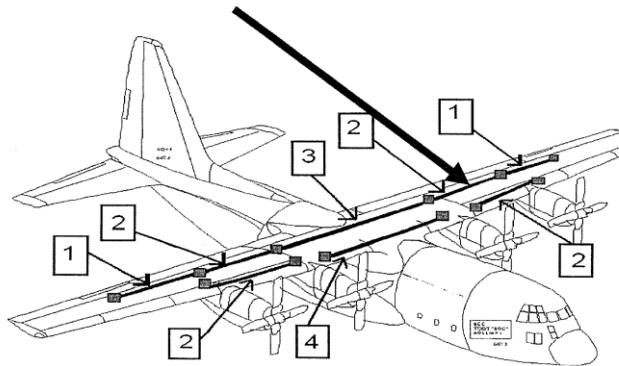

Attach appropriate cable lengths at points indicated with matching number.

Cable number	Cable lengths
1	17' 7"
2	17' 2"
3	34"
4	30"

Travel Restraint system installed on AFSOC C-130s post flight to provide protection atop of aircraft.

### 15.9.9.2 Vacuum System-

Vacuum systems make use of an anchor connector that creates a vacuum between the vacuum system and the skin of the airframe to establish an anchorage. Systems are lightweight and effective; however is designed engineered system that current ANSI standards do not cover. Therefore, documentation from the manufacturer is required that meets the requirements set forth in OPNAVINST 5100.23G, Chapter 13, paragraph 1309.

#### NOTE

MACCLOGWING in coordination with PMA-231 has gained authorization for use of system for E-2 and C-2s.



**WARNING**

**Vacuum systems may only be utilized with permission of cognizant PMA and should be done in consultation with the airframe manufacturer.**

**WARNING**

**Vacuum systems may only be utilized in a restraint configuration at present time**

**WARNING**

**Vacuum systems are designed systems. Only connectors and lanyards provided with system may be utilized.**

**15.9.10 Personal Fall-Arrest System. (PPE)**

**WARNING**

**If Personal Fall Arrest System (PFAS) is used a rescue plan must be in place.**

July 2017

A system used to arrest a person during a fall from a working level. It consists of an anchorage system, connecting means, and full body harness. The connecting means may include a lanyard, self-retracting device, lifeline, or suitable combination of these. A personal fall arrest system shall be rigged so that the user shall not contact a lower level or object. Suitable anchorages for personal fall arrest systems are also required for horizontal lifeline systems, mobile and/or fixed anchorages attached to a rigid rail or beam.

**WARNING**

**Safety Belts (body belts) shall not be used as part of personnel fall arrest system**

**WARNING**

**On MV-22 Do Not use restraint/arrest system on forward nacelle when aircraft is in stowed position. The clearance height from the deck is greatly reduced and in the event of fall injury to part of the lower leg is likely.**



#### **15.9.10.1 Mobile Fall Arrest Systems – Single Point and Rail systems**

There are numerous options available for mobile anchor points. The system design varies widely and allow for single users or multiple users depending on design limitations. These units are found extensively at depot facilities and may be available at the Organizational level.





**NOTE**

Hundreds of portable rail systems were procured by CNAF and provided primarily to Fleet Replacement Squadrons (FRS). These stands were to be identified as Special Tools and tracked

**15.9.10.2 Overhead anchor points and rails in facilities.**

These may be improvised anchor points as selected by a competent person or a designed system attached to the structure. This may include systems installed on wash rack structures



Overhead Beam Strap with Self Retracting Lanyard

**WARNING**

**Ensure the structure has the required strength if anchors are selected**

July 2017

**NOTE**

Commercially available engineered systems are recognized as effective Fall Protection and may be used. Commercially available engineered systems shall be designed, installed, certified and used under the supervision of a Qualified Person. The systems shall be used per manufacturer's instructions and recommendations. The CP for FP may (if deemed appropriate by the Qualified Person), may supervise the assembly, disassembly, use, and inspection of the engineered system, under the direction of the QP.

**NOTE**

The design shall include drawings, required clearance, and instructions on proper installation, use, and inspection requirements.

**15.9.10.3 Horizontal Lifeline Systems**



**WARNING**

**HLL Systems must be inspected IAW the stamped installation drawings or annually by a Qualified Person**

### 15.10 Administrative controls.

These are controls that reduce risks through specific administrative actions. Methods for implementing administrative controls include:

- a) Fall Hazard Awareness Training for personnel performing elevated work.
- b) Providing suitable warnings, markings, placards, signs and notices.
- c) Establishing written policies, programs, instructions, and SOPs.
- d) Conducting a deliberate RM with consideration of the following as a minimum.
  1. Maintenance or inspection work duration,
  2. Environmental factors such as wind, rain, snow, or ice,
  3. Probability of fall,
  4. Hazards of fall (obstacles, height, etc.)
  5. Slippery materials or substances on aircraft surfaces
  6. Actual requirement for work to be completed
- e) Limiting the exposure to a hazard (by reducing the number of personnel, and/or the length of time personnel are exposed).

#### 15.10.1 Fall Mitigation Adjuncts

This is equipment that is not fall protection but may reduce the possibility of fall (nonskid, booties) or may reduce the severity of injury from a fall.

#### **WARNING**

**A cranial Is Not Fall Protection. It has limited capacity to attenuate impact energy. The Advanced cranial prototypes attenuate a significantly greater amount of impact energy as comparable to a Z10 hardhat. Contact NAVAIR 4.6.5.3 for further information.**





### **15.11 INSPECTION, CARE, MAINTENANCE AND STORAGE OF FALL PROTECTION EQUIPMENT**

Chapter 11 of the DON Fall Protection Guide provides guidance, checklists, and specific requirements for this topic. The fall protection program instruction must address specific inspection, maintenance, storage, and care procedures for the fall protection equipment possessed and/or utilized by the command. Manufacturers' instructions and recommendations may provide a good starting point for these requirements. Checklists, maintenance requirement cards, and pre-operational inspection cards should be developed for each piece of fall protection equipment by a competent person for fall protection or fall protection program manager and approved by the responsible authority.

### **15.12 RESCUE PROCEDURES**

Chapter 10 of the DON Fall Protection Guide provides guidance and templates for this requirement. A site specific rescue plan shall be prepared in writing and maintained for all instances where personnel work at heights while utilizing harness-type fall protection systems. If the rescue will be performed by the Fire Department or other Governmental Jurisdictional Agency, a written Pre-Incident Plan is required. The rescue plan shall contain detailed procedures on the methods of rescue to include methods of self-rescue/assisted rescue, equipment used in the rescue procedure, training requirements including specialized training for rescuers, procedures for requesting rescue, and a pre-mishap medical plan should medical assistance be required. The rescue plan shall be included as part of the written site specific Fall Protection Program.

#### **WARNING**

**Calling 911 is not a rescue plan.  
If base or local fire is the response plan than you must have  
confirmation that they can respond and recover within 30  
minutes and that must be included in the plan**

### **15.13 AUDITS AND EVALUATIONS**

Chapter 3 of DON the Fall Protection Guide provides compliance checklist for the Fall Protection Program which can be used for auditing the program. Program audits should be conducted semiannually, but shall be conducted annually as part of the command safety self-assessment described in OPNAVINST 5100.23 (series).

### **15.14 FUNDING AND PROCUREMENT OF FALL PROTECTION EQUIPMENT**

Fall protection equipment required but not provided through support equipment (S/E) avenues should be procured by the squadron or type wing. If squadron or type wing funding is

July 2017

unavailable, funding may be available for fall protection methods and solutions through the Navy Hazard Abatement Program. The Hazard Abatement (HA) Program is a part of the Navy and Marine Corps Mishap Prevention and Hazard Abatement (MPHA) Program managed by NAVFAC.

The Navy and Marine Corps Hazard Abatement program evaluates all submitted hazard abatement funding requests from all hazard areas before determining what projects shall be selected for funding. The program has funded several aircraft fall protection projects and helped determine appropriate solutions; but each submitted Hazard Abatement project is evaluated on its merits before being selected for completion. Furthermore, this is no guarantee of selection for a submitted project. The project screening and selection process normally takes place annually, with projects selected for completion in the following fiscal year.

The point of contact for the Hazard Abatement Program can be reached at [MPHA.fct@navy.mil](mailto:MPHA.fct@navy.mil).

July 2017

**15.15 CNAF MESSAGE**

RAAUZYUW RULYFOO0115 3460022-UUUU--RULYSUU.  
ZNR UUUUU  
R 201800Z MAR 14 ZYB  
FM COMNAVAIRFOR SAN DIEGO CA//N45/N42//  
TO AIRTEVRON NINE CHINA LAKE CA  
AIRTEVRON ONE  
CARAEWRON ONE TWO ZERO  
COMACCLOGWING PT MUGU CA  
COMHELMARSTRIKEWINGLANT MAYPORT FL//N45//  
COMHELMARSTRIKEWINGPAC SAN DIEGO CA//N45//  
COMHELSEACOMBATWINGLANT NORFOLK VA//N45//  
COMHELSEACOMBATWINGPAC SAN DIEGO CA//N45//  
COMSTRKFIGHTWINGLANT OCEANA VA//N45//  
COMSTRKFIGHTWINGPAC LEMOORE CA//N45//  
FLELOGSUPPRON FOUR ZERO  
FLELOGSUPPRON THREE ZERO  
HELMARSTRIKERON FOUR ZERO  
HELMINERON FIFTEEN  
HELSEACOMBATRON THREE  
HELSEACOMBATRON TWO  
NAS FALLON NV  
NAS LEMOORE CA  
PATRON THREE ZERO  
STRKFITRON ONE TWO TWO  
STRKFITRON ONE ZERO SIX  
VAQRON ONE TWO NINE  
INFO CNO WASHINGTON DC//09F/N45//  
COMUSFLTFORCOM NORFOLK VA//N45//  
COMPACFLT PEARL HARBOR HI//N01CE2//  
COMNAVAIRLANT NORFOLK VA//N423/N45/N450//  
COMNAVSAFECEN NORFOLK VA  
COMNAVREG SW SAN DIEGO CA//N45//  
COMPATRECONGRU NORFOLK VA//N45//  
BT  
UNCLAS  
MSGID/GENADMIN/MIL-STD-6040(SERIES)/B.0.01.00/-/-/-/-/-/-//  
SUBJ/FALL PROTECTION PROGRAM STATUS//  
REF/A/MSGID:GENADMIN/COMNAVAIRFOR/290027ZSEP2010/-//  
REF/B/MSGID:DOC/OPNAVINST 5100.23G CH1/21JUL11/-//  
REF/C/MSGID:DOC/SECNAV/22JAN09/-//  
REF/D/MSGID:GENADMIN/ALNAV 017/09/-//  
REF/E/MSGID:DOC/NAVY EXECUTIVE SAFETY BOARD/AUG 13/-//  
REF/F/MSGID:REG/29 CFR 1910.23/FEDOSH 1984/-//

July 2017

REF/G/MSGID:DOC/COMNAVAIRFORINST 5040.1D/03DEC12/-//

REF/H/MSGID:DOC/COMNAVIARFORINST 4790.2B CH1/15JUN13/-//

POC/SHAUB, CURTIS CAPT/ACOS N45/UNIT:CURTIS.SHAUB(AT)NAVY.MIL

/NAME:DSN 735-2785/TEL:COMM 619-545-2785//

POC/SMAJDEK, JOHN CAPT/ACOS N42/UNIT:JOHN.SMAJDEK(AT)NAVY.MIL

/NAME:DSN 735-1406/TEL:COMM 619-545-1406//

NARR/REF A IS IMPLEMENTATION OF FALL PROTECTION PROGRAM FOR AVIATION MAINTENANCE AND REPAIR MESSAGE. REF B IS THE NAVY SAFETY AND OCCUPATIONAL HEALTH PROGRAM MANUAL. REF C IS THE SECNAV SAFETY VISION RELEASED BY SECNAV, CNO, AND CMC ON 22 JAN 09. REF D IS ALNAV FROM SECNAV ANNOUNCING THE RELEASE AND IMPLEMENTATION OF THE DON SAFETY VISION FOR 2009 AND BEYOND. REF E IS THE DEPARTMENT OF THE NAVY FALL PROTECTION GUIDE FOR ASHORE FACILITIES. REF F IS THE FEDERAL OCCUPATIONAL SAFETY AND HEALTH ADMINISTRATION FALL PROTECTION PROGRAM REGULATION. REF G IS THE COMMANDER, NAVAL AIR FORCES, INSPECTIONS, CERTIFICATIONS, ASSESSMENTS, AND OPTIONAL ASSIST VISITS (ICAVS) INSTRUCTION. REF H IS THE NAVAL AVIATION MAINTENANCE PROGRAM.

GENTEXT/REMARKS/1. THIS IS A COORDINATED CNAP/CNAL N45/N42 MESSAGE. THE SAFETY OF OUR MILITARY AND CIVILIAN PERSONNEL IN THE WORKPLACE REMAINS A TOP PRIORITY. THE EQUIPMENT WE UTILIZE MUST ALSO ENHANCE MAINTENANCE AND COMPLY WITH OCCUPATIONAL SAFETY AND HEALTH ASSOCIATION (OSHA) DIRECTIVES. OUR NEW CNAP/CNAL SAFETY AND OCCUPATIONAL HEALTH PROGRAM FOR AFLOAT AND ASHORE COMMANDS, 5100.4, IS IN ITS FINAL QA STAGE. THIS UPDATED INSTRUCTION NOW INCLUDES A FULL NEW CHAPTER ON FALL PROTECTION. ALL ACTIVITIES ARE ENCOURAGED TO EMBRACE THESE NEW SAFETY INITIATIVES. FURTHER, OUR INTENT IS TO VALIDATE LOCATION OF PREVIOUSLY DELIVERED FALL PROTECTION EQUIPMENT, VALIDATE OSHA COMPLIANCE AND BRING EQUIPMENT INTO NEW AND EVOLVING OSHA SPECIFICATIONS WHEN AND WHERE REQUIRED. THE FOLLOWING AIRCRAFT REPORTING CUSTODIANS WERE AUGMENTED WITH CONTRACT MAINTENANCE MANPOWER FUNDED BY CNAP/CNAL:

A. COMHSCWL; HM-14, HM-15 AND HSC-2

B. COMHSCWP; HSC-3

C. COMHSMWL; HSM-40

D. COMHSMWP; HSM-41

E. COMVAQWP; VAQ-129

F. COMSFWL; VFA-106

G. COMSFWP; VFA-122

H. COMACCLW; VAW-120, VRC-30, VRC-40

I. VP-30, VX-1, VX-9

J. NAS FALLON OMD SAR, NAS LEMOORE OMD SAR

2. PER REFS A THROUGH H, ALL NAVAL AVIATION COMMANDS, EXCEPT CVN'S AND ACTIVITIES FORWARD DEPLOYED TO A COMBAT ZONE, WITH POTENTIAL FALL HAZARDS OF GREATER THAN 4 FEET ARE REQUIRED TO IMPLEMENT A

July 2017

COMPREHENSIVE FALL PROTECTION PROGRAM FOR ALL MILITARY, U.S. GOVERNMENT CIVILIAN, AND CONTRACTOR PERSONNEL.

3. CURRENTLY AWARDED CONTRACTS THAT PROVIDE AVIATION MAINTENANCE SERVICES TO ACTIVITIES IN PARAGRAPH 1 REQUIRE THE GOVERNMENT TO PROVIDE OSHA COMPLIANT FALL PROTECTION EQUIPMENT FOR CONTRACTOR USE.

4. TYPE WINGS ARE DIRECTED TO REPORT STATUS OF FALL PROTECTION PROGRAM FOR ASSIGNED ACTIVITIES WITHIN 30 DAYS OF RECEIPT OF THIS MESSAGE. FOR THOSE ACTIVITIES NOT ASSIGNED TO A TYPE WING REPORT DIRECTLY TO CNAF N45/N42. STATUS UPDATE DATA ELEMENTS:

A. HAS ACTIVITY FALL PROTECTION PROGRAM MANAGER, COMPETENT PERSON AND QUALIFIED PERSON COMPLETED TRAINING REQUIREMENTS PER REF B?

B. STATUS OF FALL PROTECTION EQUIPMENT PROVIDED BY CNAF IN 2010.

SPREAD SHEET OUTLINING EQUIPMENT PURCHASED BY CNAF FOR EACH COMMAND WILL BE FORWARDED TO ACTIVITY AND ISIC VIA SEPCOR.

C. IS SUFFICIENT OSHA COMPLIANT FALL PROTECTION EQUIPMENT AVAILABLE AT THE ACTIVITY HOME SITE AND ASHORE DETACHMENT LOCATIONS TO SUPPORT CONTRACTOR MAINTENANCE OPERATIONS WITHIN THE HANGAR, FLIGHT LINE AND WASH RACK MAINTENANCE AREAS?

D. IF SUFFICIENT FALL PROTECTION EQUIPMENT IS NOT AVAILABLE, IDENTIFY EQUIPMENT TYPE AND QUANTITY REQUIRED TO BRING PROGRAM INTO COMPLIANCE.

5. THE COMMAND FALL PROTECTION PROGRAM, AS WELL AS OTHER REQUIRED SAFETY PROGRAMS, SHALL BE PERIODICALLY INSPECTED DURING SAFETY AND OCCUPATIONAL HEALTH MANAGEMENT EVALUATIONS BY EACH TYPE WING AND TYCOM IN ACCORDANCE WITH REF G. ADDITIONAL INSPECTIONS OF THESE PROGRAMS BY COMMANDER NAVAL INSTALLATIONS COMMAND, NAVAL SAFETY CENTER AND NAVY INSPECTOR GENERAL MAY BE CONDUCTED IN ACCORDANCE WITH REF B.

6. CONTINUED VIGILANCE AND LEADERSHIP INVOLVEMENT AT ALL LEVELS OF COMMAND IS REQUIRED TO MAINTAIN THE FALL PROTECTION PROGRAM AND TO MEET THE DON SAFETY VISION AND SECDEF'S MISHAP REDUCTION GOALS.

7. FOR QUESTIONS CONCERNING THIS MESSAGE OR CNAF POLICY IRT FALL PROTECTION CONTACT LCDR SHAWN CRAWFORD, CNAF N45I, 619-545-1074, DSN 735-1074, SHAWN.CRAWFORD@NAVY.MIL OR FRANK (BUD) NELSON, CNAF N422AC, 619-545-5370, DSN 735-5370, FRANK.NELSON@NAVY.MIL//

BT

#0115

July 2017

## **15.16 FALL PROTECTION FORMS/CHECKLISTS**

The following are Site Specific Checklists to assist Aviation Commands develop fall protection program documentation. The checklists include:

- 15.16.1 Fall Hazard Survey Report;**
- 15.16.2 Fall Protection and prevention plan;**
- 15.16.3 Rescue Plan.**

The fall hazard forms above have been loaded to Naval Forms On-Line.

SECNAV 5100/2T Site-Specific Fall Hazard Survey:

[https://navalforms.documentservices.dla.mil/formsDir/\\_SECNAV\\_5100\\_2T\\_11021.pdf](https://navalforms.documentservices.dla.mil/formsDir/_SECNAV_5100_2T_11021.pdf)

SECNAV 5100/3T Fall Protection and Prevention Plan:

[https://navalforms.documentservices.dla.mil/formsDir/\\_OPNAV\\_5100\\_3T\\_11022.pdf](https://navalforms.documentservices.dla.mil/formsDir/_OPNAV_5100_3T_11022.pdf)

SECNAV 5100/4T Site-Specific Fall Arrest Rescue Plan:

[https://navalforms.documentservices.dla.mil/formsDir/\\_SECNAV\\_5100\\_4T\\_11023.pdf](https://navalforms.documentservices.dla.mil/formsDir/_SECNAV_5100_4T_11023.pdf)

(Continued on next page)

July 2017

### 15.16.1 Sample Site-Specific Aviation Maintenance Fall Hazard Survey Report (Form)

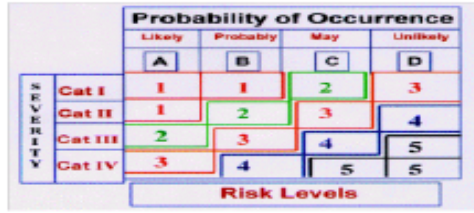
SITE-SPECIFIC FALL HAZARD SURVEY						E-Mail
<b>GENERAL INFORMATION</b>						
1. Activity/Command Name:					2. Date:	
3. Hangar/Facility Number:			4. Work Area:			
4. Survey Conducted By (Name, title, code):		5. Date Conducted:	6. Approval By (Name, title, code):		7. Date Approved:	
8. Fall Hazard Number (ex., 1, 2, etc.)		9. FP Program Manager (Name, Code):				
<b>SURVEY INFORMATION</b>						
10. Major Fall Hazard Type:				11. Work Location:		
12. Personnel Interviewed				Add Personnel Interviewed		Remove Personnel Interviewed
13. Guiding Regulation		14. Work Type:		15. Suggested Anchorages(s) (If fall arrest system used):		
16. Distance to Deck (Ft):	17. Number of Personnel Exposed to Fall Hazard:	18. Frequency/Duration of Fall Exposure:	19. Exposure Risk:	20. Potential Severity of Fall:	21. Obstructions in Fall Path:	
22. How is Fall Area Accessed:		23. Condition of Floor/ Other Surfaces:	24. Historical Fall Mishaps at the Facility:	25. Lock Out/Tag Out Hazard:		
26. Is There a Risk of the Following (Check all that apply):			27. Recommended Fall Protection Solutions (Check all that apply):			
<input type="checkbox"/> Hot Objects <input type="checkbox"/> Chemical Hazards <input type="checkbox"/> Abrasive Surfaces <input type="checkbox"/> Sparks <input type="checkbox"/> Electrical Hazards <input type="checkbox"/> Moving Equipment <input type="checkbox"/> Flames <input type="checkbox"/> Sharp Objects <input type="checkbox"/> Active Flight Line			27a. Fall Arrest (FA) System: F <input type="checkbox"/> Horizontal Life-Line A <input type="checkbox"/> Portable System T <input type="checkbox"/> Overhead Beam Strap Y <input type="checkbox"/> Self-Retracting Lanyard P <input type="checkbox"/> Self-Retracting Lanyard E <input type="checkbox"/> Energy Absorbing Lanyard		27b. Maintenance Stand w/rails: Type <input type="checkbox"/> B-Stand <input type="checkbox"/> Commercial Stand <input type="checkbox"/> Restraint System <input type="checkbox"/> Positioning System <input type="checkbox"/> Aerial Lift/Work Platforms	
28. Anchorage(s) Locations (If applicable):			27c. Other Fall Protection Methods:			
29. Can Rescue Be Performed if Required:		30. Type of Rescue:				
30a. Explain Other:						
31. Do You Have a Written Rescue Plan:		32. Are End Users Trained on Fall Arrest System:	33. Do Swing Fall Hazards Exist:	34. Is End User Refresher Training Conducted as Per OPNAVINST 5100.23G:		
<b>RISK ASSESSMENT CODE (RAC): 1= CRITICAL</b>						
CATEGORY 1 - The hazard may cause death, loss of facility/asset or result in grave damage to national interests.  CATEGORY 2 - The hazard may cause severe injury, illness, property damage, damage to national or service interests or degradation to efficient use of assets.  CATEGORY 3 - The hazard may cause minor injury, illness, property damage, damage to national service or command interest or degradation to efficient use of assets.  CATEGORY 4 - The hazard presents a minimal threat to personnel safety or health, property, national, service or command interests or efficient use of assets.				 <p>The matrix shows Risk Levels (1-5) based on Severity (I-IV) and Probability (Likely, Probably, May, Unlikely). Risk Level 1 is Critical, 2 is High, 3 is Moderate, 4 is Low, and 5 is Minimal.</p>		



### 15.16.2 Sample Aviation Fall Protection and Prevention Plan (Form)

<b>FALL PROTECTION AND PREVENTION PLAN</b>		<input type="button" value="E-Mail"/>
<i>To be completed by the Competent Person (CP), Qualified Person (QP), or Program Manager (Aviation)</i>		
<b>GENERAL INFORMATION</b>		
1. Activity/Command Name:		2. Date:
3. Hangar/Facility Number:	4. Detailed Location:	
5. Plan Prepared By (Name, Title, code):		
6. Date Fall Protection and Prevention Plan Modified/Implemented:		<input type="button" value="Add Date Field"/> <input type="button" value="Remove Date Field"/>
Date Plan was Modified:	Date This Modification Implemented:	
Date Plan was Modified:	Date This Modification Implemented:	
Date Plan was Modified:	Date This Modification Implemented:	
7. Task/Wok Description:		
8. Name(s) of Personnel Exposed to Fall Hazards:		<input type="button" value="Add Name Field"/> <input type="button" value="Remove Name Field"/>
<b>ANCHORAGE(S)</b>		
9. Anchorage Location:	10. Anchorage Strength:	
<b>TRAINING</b>		
11. Fall Protection Program Manager training Completed::	12. End User Training Completed:	
13. Description of the Fall Protection System to be used:		
14. Free Fall Distance:	15. Total Fall Distance:	
16. Description of Anchorage(s):		
17. Other Systems Used:		
Description of Other System Used:		<input type="button" value="v"/>
18. Special Pre-Use Instructions::		
19. Special Post-Use Instructions:		

### 15.16.3 Sample Site-Specific Fall-arrest Rescue Plan

SITE-SPECIFIC FALL ARREST RESCUE PLAN		<input type="button" value="E-Mail"/>	
<b>GENERAL INFORMATION</b>			
1. Activity/Command Name:		2. Date:	
3. Hangar/Facility Number:		4. Phone:	
5. Detailed Location:			
6. First Aid Kit Location(s):		<input type="button" value="Add Location Field"/>	<input type="button" value="Remove Location Field"/>
1:			
2:			
3:			
7. Fire Extinguishert Location(s):		<input type="button" value="Add Location Field"/>	<input type="button" value="Remove Location Field"/>
1:			
2:			
3:			
8. Ladder/Lift Location:			
9. Nearest Medical Facility:			
10. Procedures for Requesting Rescue:		<input type="button" value="Add Procedure Field"/>	<input type="button" value="Remove Procedure Field"/>
1:			
2:			
3:			
4:			
5:			
11. Describe Rescue Operation and Method:			
12. Types of Equipment used ( <i>Ladder, Hoist, Aerial Lift, etc.</i> ):			
13. Specialized Training for the Rescue Team:			
14. Has Rescue Plan Been Developed in Coordination with Local Emergency Services ( <i>Essential if relying on them to provide rescue</i> ):			
15. Additional Comments:			
16. Prepared By ( <i>Name, Title, Code</i> ):			
17. Date Fall Arrest Plan Approved:	18. Printed Name, Title, Code of FFPM:	19. Signature Date:	20. Signature of FFPM: 

### **15.17 EXAMPLES OF FALL PROTECTION PROGRAM DOCUMENT TEMPLATES**

The following are templates to assist DON Aviation Commands establish, implement and manage viable fall protection programs. These templates include the following:

- (1) Written Fall Protection Program Template;
- (2) Fall Hazard Survey Report Template;

### 15.17.1 WRITTEN FALL PROTECTION PROGRAM TEMPLATE (Specific to Aviation Commands)

#### COMMAND NAME INSTRUCTION XXXX.XX

From: Commanding Officer, **COMMAND NAME**

Subj: FALL PROTECTION PROGRAM MEMORANDUM

Ref: (a) OPNAVINST 5100.23(series); MCO 5100.29 (series) or NAVMC DIR 5100.8  
(b) DON Fall Protection Guide  
(c) CNICINST 5100.3  
(d) OPNAVINST 5102.1(series)  
(e) OPNAVINST 3500.39 (series)

Encl: (1) Fall Hazard Survey Report  
(2) Fall Protection and Prevention Plan

1. Purpose. The purpose of this instruction is to establish a command Fall Protection Program, provide policy and requirements for the implementation of the program, and establish procedures on fall protection and fall prevention for **COMMAND NAME** personnel working at heights and/or exposed to fall hazards while conducting aircraft maintenance and inspection work.

2. Applicability. This program applies to all **COMMAND NAME** military and DON civilian personnel who are exposed to fall hazards when performing maintenance or inspection work on an elevated, walking, or working surface with unprotected sides, edges, or openings, from which there is a possibility of falling four feet or more to a lower level; or where there is a possibility of a fall from any height onto dangerous equipment, into a hazardous environment, or onto an impalement hazard.

3. Cancellation. Instruction XXXX.XX

4. Background. Falls from heights are a major cause of injuries and fatalities in the work place. Reference (a) directs all Navy and Marine Corps ashore activities to establish a managed fall protection program. The nature of aviation maintenance and inspection requires that **COMMAND NAME** personnel work at heights, thereby exposing them to fall hazards.

**5. Command Fall Protection Policy. **COMMAND NAME** is committed to provide a safe working environment for its personnel exposed to fall hazards and eliminating preventable mishaps. Mission accomplishment is our number one task, but we cannot accomplish this task if we do not do our utmost to ensure the safety of our personnel. This program is part of an overall command safety program designed to enhance**

**operational readiness by preventing injury or death of personnel through careful management of material resources.**

**a. **COMMAND NAME** personnel shall take every reasonable precaution to protect themselves and others while working at heights.**

**b. In accordance with reference (a), **COMMAND NAME** may use the Department of the DON Fall Protection Guide [reference (b)], as a guide when creating their own site specific program, plans, and policies.**

6. Duties and Responsibilities. **COMMAND NAME** leadership shall ensure that all personnel assigned to the fall protection program have the necessary skills, knowledge, training, and expertise to manage, administer, and implement the fall protection program.

a. Command Safety Officer: Shall provide oversight of the command Fall Protection Program.

b. The Command Fall Protection Program Manager shall:

(1) Develop and implement the command fall protection program.

(2) Manage and coordinate the command's core Fall Protection program.

(3) Perform and document reviews, and evaluations of operations, facilities, materials, and equipment affecting fall protection.

(4) Conduct fall hazard survey and prepare survey report.

(5) Coordinate workplace and personal fall protection system inspections with the supporting Competent Person for Fall Protection.

(a) The Competent Person support services can be requested from the supporting Regional/local installation safety office.

(b) The Competent Person services may be provided by command personnel if they have completed the required training course as described in Appendix 13-A of reference (a) and paragraph 6.2 of reference (b) .

(6) Correct or abate identified fall hazards.

(7) Obtain consulting services from the supporting Regional/local installation safety office on technical aspects of the program.

(8) Coordinate with the supporting Regional/local installation safety office to analyze core effectiveness through the annual safety self-assessment process.

(9) Coordinate core fall protection training for all personnel who are exposed to fall hazards (End-users) and other personnel involved in the program, when applicable.

(10) Coordinate with the supporting Regional/local installation safety office any other support described in Table 1 of reference (c) required to ensure the proper management of this program.

7. Fall-hazard Prevention and Control. Reference (a) requires each DON activity to survey the workplace to identify potential fall hazards and prepare a "Fall Hazard Survey Report". Reference (a) requires a "Fall Protection and Prevention Plan", prepared by a Competent Person for Fall Protection, or by a Qualified Person for Fall Protection, as part of a managed fall protection program. The trained FPPM may also prepare the fall protection and prevention plan

a. The Fall Protection and Prevention Plan shall provide site specific guidance for tasks executed at **COMMAND NAME**.

b. Prior to visiting a site at another Navy Activity, **COMMAND NAME** employees who will be climbing or using ascending equipment different from the equipment addressed in the **COMMAND NAME** Fall Hazard Survey Report should review that the host Activity's "Fall Hazard Survey".

8. Fall Protection Training. **COMMAND NAME** personnel who have the potential for exposure to fall hazards and/or those involved in the Fall Protection Program shall be trained in fall prevention and fall protection in accordance with the requirements in reference (a), and the training requirements in reference (b). A Competent Person or a vendor who has the knowledge, expertise, and education to deliver the training shall train end-users.

a. Initial Training. Command personnel exposed to fall hazards shall complete the following training:

(1) Fall hazard awareness training: general fall hazard awareness training shall be provided by either a Competent Person for Fall Protection or by completion of a Navy-approved general fall hazard awareness training, such as the Enterprise Safety Applications Management Systems (ESAMS) course #1259.

(2) Personnel required to climb aircraft shall be qualified climbers.

(a) Qualified climbers shall be trained and knowledgeable regarding those surfaces which are, and are not, able to support a climber; and shall observe airframe restrictions. Training shall include:

- Requirement for cranial protection
- Areas on airframe authorized for use as a step

- Checking to ensure that steps are cleaned of slippery substances
- Instruction to maintain three points of control on aircraft at all times

(b) Qualified climbers shall rely on experience, proper training, and the use of time-critical RM as described in reference (e) to minimize the risk of a fall.

- (3) End-users of Fall-Protection shall also undergo “Hands-On” training on the specific personal fall-protection system and equipment used at the command. This training must be performed by a Competent Person for Fall Protection. End-user training shall include training on:

- Safe use of equipment
- Proper application of equipment
- Equipment limits
- Estimation of fall distances and clearance requirements
- Methods of inspection, storage, care, and maintenance
- Applicable regulations
- Proper anchoring and tie-off techniques
- Recognition of fall-hazard deficiencies
- Site specific procedures.

b. Retraining. Retraining in relevant topics shall be provided to the end-user and/or qualified climbers when:

- (1) Personnel have been observed using maintenance stands or fall protection equipment in an unsafe manner.
- (2) Personnel have been involved in a mishap or a near-miss incident.
- (3) Personnel have received an evaluation that reveals that he or she is not using the fall protection equipment properly.
- (4) An End-user is assigned a different type of fall protection equipment.
- (5) A condition in the workplace changes in a manner that could affect the safe use of the fall protection equipment that the end-user is to utilize.

c. Refresher training. Personnel exposed to fall hazards shall receive periodic awareness and hands-on equipment (when applicable) refresher training as required by reference (a) and (b).

9. Inspection, Storage, Care, and Maintenance of Fall Protection Equipment. Command fall protection equipment shall comply with the requirements of reference (a); applicable requirements in reference (b); and the manufacturer’s requirements for the inspection, storage, care and maintenance of fall protection equipment.



July 2017

a. A Competent Person for Fall Protection or a Competent Person for Equipment Inspection shall perform a documented inspection on each piece of fall protection equipment annually using criteria found in reference (b) or appropriate Maintenance Required Card (MRC).

b. End-users of Fall Protection shall inspect fall protection equipment prior to each use using criteria in reference (b) or appropriate MRC whichever is more stringent.

10. Mishap Reporting.

a. Any fall-from-height experienced by command personnel shall be reported to the FPPM or Safety Officer.

b. If a fall results in fall-arrest equipment activation, the event shall be reported as a near-miss using the Hazard Report in reference (c).

11. Program Audits and Evaluation. The FPPM shall audit the program annually (at a minimum) per Chapter 3 of reference (a).

12. Rescue Plan. When fall-arrest systems are utilized the FPPM shall coordinate with the supporting Competent Person for Fall Protection to create a rescue plan which meets the requirements in reference (b). The rescue plan shall then be incorporated into the command Fall Protection Program.

(Signed) C. O. COMMAND

July 2017

**15.17.2 FALL HAZARD SURVEY AND ASSESMENT REPORT (Example HSM 40)**

**(See Appendix I)**

**End of Section**

## **16.0 FALL PROTECTION REQUIREMENTS FOR ARCHITECTS, ENGINEERS AND OTHER INSPECTORS CONDUCTING INSPECTION, INVESTIGATION AND ASSESSMENT WORK OF ROOFS, GENERAL INDUSTRY WORKPLACE CONDITIONS OR CONDUCTING FALL HAZARD SURVEYS**

### **16.1 BACKGROUND**

Roof systems can deteriorate from normal wear; severe weather conditions (e.g., wind and snow loads); building movement (e.g., settlement, material contraction and expansion); improper design, construction, and maintenance. Any roof repairs not dealt with after the first signs of failure can result in increased damage to the building envelope and interior finishes, and loss of occupant productivity, if damage causes interruption in services and program delivery. Failure of structural integrity can endanger the safety of building occupants. Inspection, investigation and assessment work is required to determine the condition of the roof. Additionally, for general industry workplace conditions or when conducting fall hazard surveys will also require inspection and investigation work.

### **16.2 PURPOSE**

The purpose of this chapter is to provide instructions, requirements, and guidance when conducting investigation, inspections or assessment work of roofs, general industry workplace conditions or fall hazard surveys, in a safe manner. This instruction does not apply to safety procedures for performing work on roofs by Public works personnel, and or roofing contractors. It only applies to inspecting, investigating, or assessing existing roof systems, general industry workplace conditions or conducting fall hazard surveys where there is no construction or general industry work in progress. For safety requirements regarding roof construction see EM 385-1-1, Section 21 Fall Protection, Unified Facilities Guide Specifications (UFGS) Section 01 35 29.05 20 "Safety and Occupational Health Requirements for Design Build", and UFGS 01 35 29 Governmental Safety Requirements for Design Bid Contracts. . The checklist in paragraph 16.13 is provided as a guide for safety procedures during roof inspection, assessment, and investigation work, to protect DON personnel from unexpected falls from heights (or on the same level). This checklist may be modified as required by the qualified DON Engineer, Architect or other inspectors responsible for each specific project, after consultation with the Command Safety Office.

Regular inspection of building roof system or workplace conditions (i.e. mechanical equipment) can lead to early detection of roof problems, protection of Government capital assets, and maintenance of safe working environments for building occupants.

### **16.3 OBJECTIVES**

Protection of DON architects/engineers and other inspectors when accessing roofs to conduct investigation, assessment and inspection tasks to determine whether or not the roof system is performing according to its intended function, and to identify signs of weakness or, deterioration, for the purpose of scheduling needed repairs or replacement of roofing material in addition to conducting inspections of workplace conditions.

## **16.4 RESPONSIBILITIES**

It is the responsibility of each individual performing inspection, investigation and assessment, work, to insure that he or she understands and fully complies with all required safety instructions, and has the proper safety equipment specified by this guidance, or by the project manager. The inspection and investigation work shall be conducted by more than one individual. The head of the inspection team is responsible for verifying with the Command safety office at each activity to determine whether or not there are additional relevant local safety instructions and/or requirements, and for relaying that information to all team members. The cooperation of each individual is vital to the success of the safety program. Inspectors are responsible for their own safety, and always should be alert to hazards caused by others. If work cannot be performed safely, the inspection and investigation work shall not proceed until provisions have been made to conduct the work in a safe manner. Each inspector should keep in mind these basic duties and responsibilities for being safe during inspection and investigation work:

- a. Observe all safety rules.
- b. Work in accordance with established safety procedures.
- c. Report unsafe conditions and practices to the appropriate supervisor.
- d. Conduct work activities in a manner that will not endanger oneself or others.
- e. Assist new employees in safely carrying out their job duties.
- f. Report injuries immediately to the supervisor.
- g. Undertake only those jobs or tasks that you understand.

## **16.5 SAFE WORK PRACTICES**

### **16.5.1 General/Minimum Requirements**

- a. Do not access or work on a roof unless trained appropriately.
- b. Review the Fall Hazard Survey Report for the roof which has been developed by the building owner or other personnel to ensure that a proper risk assessment has been completed before accessing and/or commencing any work on roofs.
- c. Ensure that an additional roof risk assessment has been completed when accessing and working on roof during adverse weather conditions (i.e. wind, rain, excessive heat, etc.).
- d. Ensure that you wear the following personal protective equipment at all times: proper foot ware, sunscreen, sunglasses.

- e. Ensure that Public Works personnel and the Command Safety Office are aware of your presence/work on the roof and the expected time frame.
- f. Do not work on a roof alone – always work in pairs.
- g. Ensure that you have a form of communication link with safety office.
- h. Roof areas should be tidy and clean; where rubbish or stacked material interferes with ascending and performing inspection work of the roof, do not proceed until it is safe to perform the work.
- i. Ensure that there is a safe method of access to the roof and that this method is used. Ensure that all ladders are safe and any erected scaffolding is certified and safe.
- j. Ensure that there is a safe method of transporting any needed equipment to the roof work area.
- k. Make sure of the structural soundness of the roof and frame before a person walks on a roof.
- l. Be familiar with the Emergency Rescue Response Procedure and the Command fall hazard rescue plan.
- m. Flat Roofs: Personnel conducting inspection on roofs shall not proceed to within 6 feet of the edge. If work is to be performed within 6 feet of the edge, appropriate safety precautions shall be taken to minimize the risk of falling (e.g., elevating work platforms, scaffolding, temporary guardrails, Fall-arrest System, restraint or positioning, ).
- n. Pitched Roofs: Where a roof has a pitch of more than 4 in 12, where if someone fell they would roll off the roof, or the roof is deemed to be too slippery, or too fragile, then work must be carried out only by use of one or more of the following: Elevating Work Platform, Scaffolding, Guardrails (not appropriate for pitches exceeding 45 degrees), or Roof Ladder (in conjunction with other equipment, e.g., fall-arrest system).

## 16.6 CONTROL ZONES ON ROOFS

When conducting investigation, assessment or investigation work within the 6 feet from the unprotected edge of the roof, a fall protection method is required.

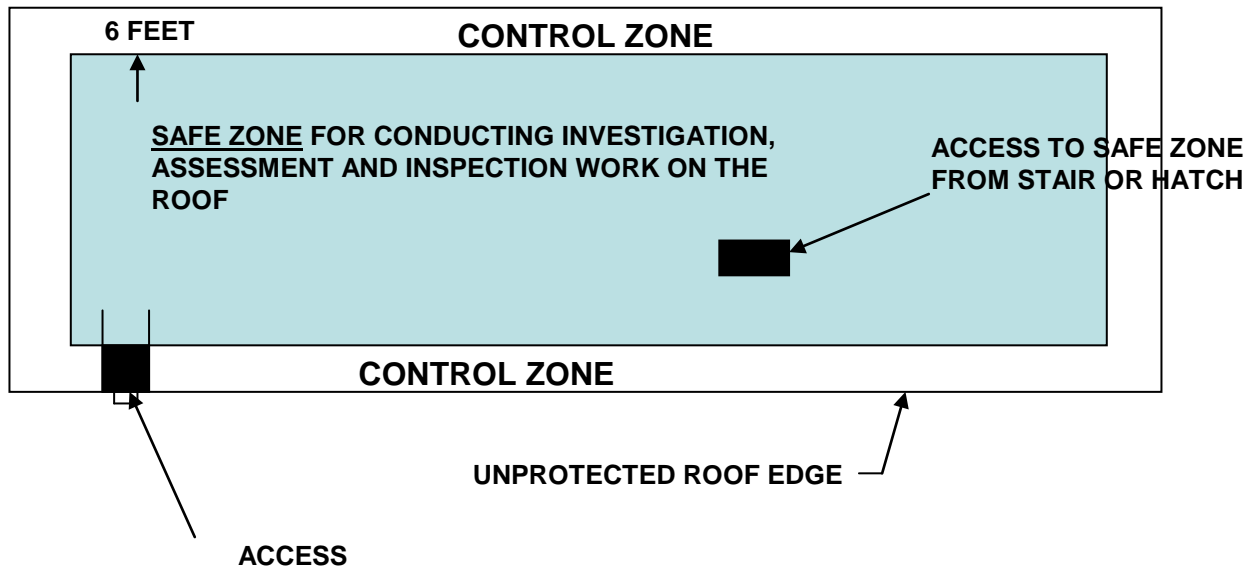

## 16.7 SAFE ACCESS

### 16.7.1 Portable Ladder Safety

- a. Use only OSHA compliant ladders.
- b. Only one person may be on the ladder at any time. One person should secure the ladder while another is climbing.
- c. **Ladder must extend a minimum of 3 – 3 ½ feet above roof edge.**
- d. **Ladder must be properly secured to roof edge immediately after initial ascent.**
- e. Maintain appropriate ladder slope as outlined by OSHA (One foot of run for every four feet of the ladder working length).

July 2017

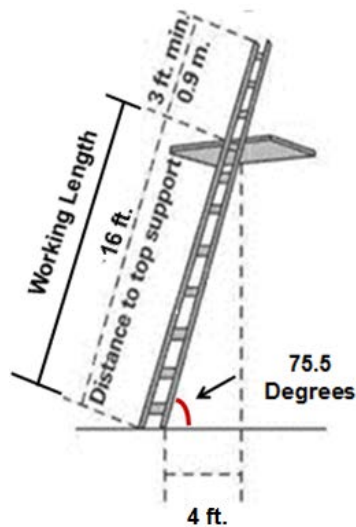

### 16.7.2 Portable Ladder Safe Work Practices.

- a. Do not exceed the weight limit of the ladder.
- b. When ascending or descending, the climber must face the ladder.
- c. Portable rung and cleat ladders shall be used at such a pitch that the horizontal distance from the top support to the foot of the ladder is one-quarter of the working length of the ladder (the length along the ladder between the foot and the top support).
- d. The ladder shall be so placed as to prevent slipping, or it shall be lashed, or held in position. The ladder base section must be placed with a secure footing.
- e. Employees shall equip all portable rung ladders with non-slip bases when there is a hazard of slipping. However, non-slip bases are not intended as a substitute for care in safely placing, lashing, or holding a ladder used on oily, metal, concrete, or slippery surfaces. These non-slip bases can be obtained from the Project Supervisor.
- f. The top of the ladder must be placed with the two rails supported, unless equipped with a single-support attachment.
- g. On two-section extension ladders, the minimum overlap for the two sections in use shall be according to OSHA specifications.
- h. Portable rung ladders with reinforced rails shall be used only with the metal reinforcement on the underside of the rails.
- i. The bracing on the back legs of step-ladders is designed solely for increasing stability, and not for climbing.
- j. Ladders shall not be:
  - 1) Used in a horizontal position as platforms, runways, or scaffolds.
  - 2) Placed in front of doors opening toward the ladder, unless the door is blocked open, locked, or guarded.
  - 3) Placed on boxes, barrels, or other unstable bases to obtain additional height.
  - 4) Tied or fastened together to provide longer sections. They must be equipped with the hardware fittings necessary if the manufacturer endorses extended uses.



- 5) Used to gain access to a roof, unless the top of the ladder extends at least 3 feet above the point of support at eave, gutter, or roofline.
- 6) Used as a brace, skid, guy, gin pole, gangway, or for other uses than that for which they were intended, unless specifically recommended for use by the manufacturer.
- k. No more than one person at any time shall use a ladder.
- l. Ladder jacks and scaffold planks, where use by more than one person is anticipated, shall utilize specially-designed ladders with larger dimensions of the parts procured from the Project Supervisor. Ladders with broken or missing steps, rungs, or cleats, broken side rails, or other faulty equipment, shall not be used. Employees finding ladders with any of these conditions shall report them to the Project Supervisor. Improvised repairs shall not be made.
- m. Ladders made by fastening cleats across a single rail shall not be used.
- n. Tops of ordinary step-ladders shall not be used as steps.
- o. Middle and top sections of sectional or window cleaners' ladders shall not be used for bottom sections, unless the user equips them with safety shoes.

**Note: For additional portable ladder safe work practices and requirements, see paragraph 9.11.2**

### 16.7.3 Fixed Ladder Safety Practices

See Paragraph 9.12.1

## 16.8 ADDITIONAL PROTECTIVE MEASURES

- a. All inspectors shall wear proper clothing. Hard hats shall be worn at the site for all roofing or general industry workplace conditions tasks and OSHA roof safety requirements shall be followed.
- b. Check ladders before use to insure they are safe, in good working order, extend at least 3 rungs above the roof edge, are properly secured, and are installed at proper slope.
- c. Drinking alcoholic beverages on the job, reporting to work intoxicated or being under the influence of drugs is strictly forbidden and not allowed on any construction site.
- d. During hot weather, be particularly aware of heat exhaustion and heat stroke symptoms. Employees should drink water frequently and get out of the sun if they become dizzy. During cold weather, be aware of hypothermia and frostbite symptoms. Employees should dress warmly (in layers), warm up frequently, and stay dry.

## 16.9 PRE-WORK CHECK

Prior to beginning the inspection, investigation and assessment work in any area or on any equipment where fall hazards exist, a pre-work check must be completed that includes the following items:

a. Ladders:

- 1) Gripping safety feet in place and secure on ladders.
- 2) Wooden ladders are sound and in good working order.
- 3) All parts and fittings on ladders are secure.
  - a) Non-slip surfaces are in place on ladder rungs.
  - b) When setting ladder up, footing of ladder is secure on a firm, level, and non-skid surface and top of ladder is placed against a solid, stationary object.
  - c) All ladders meet OSHA specifications for design and safety.
  - d) Check for unsafe ladder condition.

b. Floor & Wall Openings: All floor and wall openings (such as open roof access hatches or opening including skylights due to ongoing construction or repair work) are safely covered or blocked from access. If not safely covered and blocked from access, the opening shall have someone assigned for constant attendance to it.

c. Roof Condition:

- 1) Verify that the slope does not exceed 4 inches per foot. If the slope is more than 4 inches per foot, the use of fall protection equipment is required
- 2) Conduct interviews with local personnel familiar with the roof construction and visual inspection of roof structural deck underside to identify potential safety issues with the deck.
- 3) Ensure that the roof surface is not slippery due to water, algae, dirt, and debris that would preclude firm footing.

d. Weather:

- 1) Check the current weather to insure that none of the conditions listed above exist.

e. Work Procedures: If any one of the conditions described in Pre-Work Check list is not met for the area or piece of equipment to be inspected and posing a potential fall hazard, then employees may not perform that work until the condition is corrected. If the condition cannot be remedied immediately, a supervisor or Project Manager must be notified of the problem. If the situation calls for use of fall protection equipment such as harnesses or lanyards because the fall hazard cannot be reduced to a safe level for inspection and investigation work, then the employee shall utilize the normal safety procedures as per the local safety officer.

## 16.10 INSPECTION PROCEDURES

An inspection team shall typically consist of a minimum of two individuals. One individual shall be designated as a safety monitor/recorder and assist the inspector by maintaining visual and verbal contact at all times during the inspection work. The other shall conduct the actual inspection as per the specifics of the job. Inspection personnel shall conduct themselves in a manner that does not endanger themselves and members of the inspection team.

### **16.11 FALL PROTECTION and PREVENTION**

All team members shall maintain a safe distance from all roof edges at all times (6 feet minimum) unless being observed and assisted by the designated safety monitor and the proper fall protection is provided at the control zone.

When equipment used to conduct the roof inspection presents a hazard while ascending and accessing the roof, the inspector shall not carry the equipment. Instead, the equipment shall be transferred to the roof by rope or other means.

### **16.12 TRAINING REQUIREMENTS**

Architects/Engineers and other inspectors shall be trained prior to ascending roofs of existing buildings and facilities for the purpose of conducting inspection, investigation and assessment of roofing system or general industry workplace conditions. This training is available on Enterprise Safety Application Management System (ESAMS) Web based training course #3639.

At a minimum, all personnel conducting inspection, investigation and assessment work shall receive ESAMS training course #1259 titled Slips Trips and Same Level Falls. If inspection work is required in the control zone (within 6 feet from the edge of the roof), and personal protective equipment is used additional training is required on the safe use of the equipment. Personnel using personal fall protective equipment are required to be trained by the Command Competent Person for Fall Protection or shall receive ESAMS Course # 2018 titled End-user training and also the Hands-On Training (ESAMS Course #3042. This training is also available at E-Learning (Course # xxx) and Navy Knowledge Online (NKO), Course # xxx.

July 2017

## **16.13 REFERENCES:**

16.13.1. OPNAVINST 5100.23 Series: Navy Safety and Occupational Health Program Manual.

16.13.2. DON all Protection Guide (latest edition).

16.13.3. 29 CFR 1926.500: Fall Protection in Construction.

16.13.4. 29 CFR 1910 (1970): Occupational Safety and Health Standards for General Industry

16.13.5. 29 CFR 1910 Final Rule (17 November 2016): Walking Working Surfaces and Personal Fall Protection equipment

16.13.6. MCO 5100.29 Series: Marine Corps Safety Program.

16.13.7. NAVMC DIR 5100.8: Marine Corps OSH Program Manual.

**End of Section**

**16.13: CHECK-LIST FOR ARCHITECTS, ENGINEERS AND OTHER INSPECTORS INVOLVED IN INSPECTION, INVESTIGATION AND ASSESSMENT WORK OF ROOFS, GENERAL INDUSTRY WORKPLACE CONDITIONS OR CONDUCTING FALL HAZARD SURVEYS**

*(Must be completed prior to accessing the roof )*

**COMMAND/ACTIVITY**  
**Building Number:**

CATEGORY	ITEM	YES	NO	N/A	COMMENTS [If 'No', provide an explanation]
<b>GENERAL</b>					
TEAM MEMBERSHIP	The team shall consist of more than one person. Does the inspection team consist of more than one person?				
PURPOSE OF ROOF INVESTIGATION AND INSPECTION	Is the purpose of the inspection and investigation to determine problems with the roof itself, or inspecting and investigating general industry workplace conditions (i.e. mechanical equipment) or conducting fall hazard surveys?				
TYPE OF ROOF	Is the roof flat or minimally sloped? If the roof is steep or has a slope of more than 4/12, Fall protection equipment/system is required to perform the inspection/investigation work. A complete fall protection program shall be in place.				
COMMAND SAFETY OFFICE	Has the inspection team contacted the safety office for permission to ascend the roof and perform inspection/investigation work? (Is there any work currently being conducted on the roof?)				
<b>RESPONSIBILITIES AND BASIC DUTIES OF THE INSPECTION AND INVESTIGATION TEAM</b>					

DEPARTMENT OF THE NAVY FALL PROTECTION GUIDE

July 2017

<p><b>AWARENESS OF FALL HAZARDS ENCOUNTERED ON THE ROOF</b></p>	<p><i>Does the roof have an unprotected edge (The edge protection is less than 39 inches high)? If so, all team members shall be aware of fall hazards encountered on the roof.</i></p>				
<p><b>FALL HAZARDS ENCOUNTERED ON THE ROOF</b></p>	<p><i>Do all team members have the proper knowledge and awareness of all hazards encountered on the roof? Fall hazards may include falls from unprotected edges, holes/hatches, openings, skylights, slips and trips on the same level, etc.</i></p>				
<p><b>COMPLIANCE WITH SAFETY INSTRUCTIONS AND REQUIREMENTS</b></p>	<p><i>Do all team members understand the compliance requirements of all safety rules? Team members shall observe all safety rules and work w/established safety procedures.</i></p>				
<p><b>UNSAFE CONDITIONS AND PRACTICES</b></p>	<p><i>Are there any existing unsafe conditions or practices being conducted on the roof? Report any unsafe conditions or practices to your supervisor and the Command safety office.</i></p>				
<p><b>SAFE WORK PRACTICES</b></p>					
<p><b>FP TRAINING</b></p>	<p><i>Did all team members receive the appropriate FP training for performing roof inspections/investigation work?</i></p>				
<p><b>SITE SPECIFIC ROOF HAZARD SURVEY REPORT</b></p>	<p><i>Was the roof hazard survey report developed by the building owner and/or others, reviewed by the inspection team prior to ascending and/or commencing any work on the roof?</i></p>				
<p><b>ASCENDING THE ROOF DURING ADVERSE WEATHER CONDITIONS</b></p>	<p><i>Was any additional risk assessment performed due to adverse weather conditions?</i></p>				
<p><b>PERSONAL PROTECTIVE EQUIPMENT</b></p>	<p><i>Are all team members wearing the proper PPE for conducting roof inspection (i.e. proper footwear, etc.)?</i></p>				
<p><b>ROOF CONDITION</b></p>	<p><i>Is the roof area tidy and clean with no rubbish or stacked material that may interfere with the access and/or performance of inspection/investigation work?</i></p>				

DEPARTMENT OF THE NAVY FALL PROTECTION GUIDE

July 2017

LADDERS AND SCAFFOLDS USED FOR ACCESS	Is the ladder/scaffold used for access safe and certified?				
TRANSPORTING EQUIPMENT OR TOOLS TO THE ROOF AREA	Is there a safe method for transporting equipment or tools to the roof that may be needed for the performance of the inspection/investigation work?				
STRUCTURAL INTEGRITY OF THE ROOF	Is the roof surface structurally sound for the team members to walk on and perform inspection work safely?				
EMERGENCY RESCUE RESPONSE PROCEDURE AND COMMAND FALL HAZARD RESCUE PLAN	Is the team familiar with the rescue procedures?				
WORKING ON FLAT ROOF OR MINIMALLY SLOPED ROOFS	The inspection team shall stay at least 6 feet away from the unprotected edge of the roof. Is there a need to perform work within the 6 feet of the unprotected edge? If the answer is yes, the team must use other fall protection alternatives (i.e. personal fall protection equipment) or conduct the inspection work using AWP.				
WORKING ON PITCHED ROOF WITH MORE THAN 4/12 SLOPE	For a roof with a slope of more than 4/12, are other fall protection alternatives provided to perform the inspection/investigation work safely?				
<b>SAFE ACCESS</b>					
PORTABLE LADDER SAFETY	Are the team members familiar with the safety requirements for ascending and descending the ladder? This may include how to secure the ladder, proper slope and how to safely ascend the roof.				
ASCENDING PITCHED ROOF USING PORTABLE LADDER	When the roof has a pitch of more than 4/12 or is too slippery or fragile, the inspection/investigation work performed may require the use of an elevated work platform, scaffolding or other alternative. Is the slope of the roof more than 4/12, or is the roof too slippery or fragile?				



DEPARTMENT OF THE NAVY FALL PROTECTION GUIDE

July 2017

<p><i>ASCENDING THE ROOF USING FIXED LADDERS</i></p>	<p><i>Is the fixed ladder longer than 20 feet? If ladder is longer than 20 feet, climbing ladder fall arrest system (ladder-climbing device) or self-retracting lanyard is required for access.</i></p>				
<p><i>FIXED LADDERS LONGER THAN 20 FEET</i></p>	<p><i>If ladder is equipped w/climbing ladder fall arrest system, are all team members trained on the safe use of a climbing ladder-fall arrest system?</i></p>				
<p><i>ACCESS TO ROOF THRU A HATCH</i></p>	<p><i>After ascending the roof, is there a method for protecting the hatch when it is left open? If not, then close the hatch immediately after access.</i></p>				
<p><b>PROTECTIVE METHODS FOR CONDUCTING INSPECTION AND INVESTIGATION WORK SAFELY</b></p>					
<p><i>SAFE ZONE</i></p>	<p><i>After gaining access to the roof, is the inspection/investigation work required to be performed on a roof or mechanical equipment more than 6 feet away from unprotected roof edge? If so, inspection/investigation work can be performed in the safe zone without fall protection.</i></p>				
<p><i>CONTROL ZONE</i></p>	<p><i>Is the inspection/investigation work required to be performed within 6 feet of unprotected roof edge? If so, a fall protection method is required.</i></p>				
<p><i>ADDITIONAL PROTECTIVE MEASURES</i></p>	<p><i>Are all the team members knowledgeable on the safe use of portable and fixed ladders?</i></p> <p><i>A portable ladder shall be in good working condition, have enough length to extend more than 3 feet above the roof edge and secured properly.</i></p> <p><i>When accessing the roof via a fixed ladder, do the side rails extend 42 inches above the roof surface?</i></p>				

DEPARTMENT OF THE NAVY FALL PROTECTION GUIDE

July 2017

<b>PRE-WORK SAFETY VERIFICATION CHECK</b>					
<b>SAFETY VERIFICATION</b>	<p><i>Has safety verifications been performed on ladders, floor or wall openings, work practices the roof itself or general industry workplace conditions (i.e. mechanical equipment)?</i></p> <p><i>Have weather conditions been considered and verified?</i></p>				
<b>ADDITIONAL TRAINING</b>					
<b>SLIPS TRIPS AND SAME LEVEL FALLS TRAINING</b>	<p><i>In addition to the Architects, Engineers and other inspectors training for conducting inspection and investigation work on roofs or other workplace conditions (ESAMS course #3639), have all team members received Slips, Trips and Same Level Falls training (ESAMS course #1259)?</i></p>				

End of Section

## **17.0 OTHER FALL PROTECTION MEASURES**

### **17.1 BARRICADE AREA**

All areas must be barricaded to safeguard employees. When working overhead, barricade the area below to prevent entry by unauthorized employees. A distance of six feet shall be barricaded around the worker.

### **17.2 WARNING TAPES/SIGNS**

Construction warning tape and signs shall be posted so they are clearly visible from all possible access points. When a sign is used, it should clearly indicate the entry requirements, potential hazards, and personal protective equipment requirement.

### **17.3 HARD HAT/HARD CAP REQUIREMENTS**

Hard hats/ hard caps must comply with ISEA Z89.1, 1997 Type I, Class E & G and shall be required when workers are exposed to falling/flying objects. Furthermore, select one additional measure:

Hard hats/Hard caps must be worn any time that employees are working below other employees and/or the potential exists for falling objects to strike the employees working below. In addition to hard hats, one additional preventive measure must be implemented.

For example, when using hard hats/hard caps, the employee must use additional form(s) of protection from falling objects, such as: barricading the area or employing protective canopy structures or platforms with toe boards.

### **17.4 CLOTHING AND SAFETY SHOES**

Suitable clothing shall be worn. Sufficient and proper clothing shall be worn to assist in preventing scratches, abrasions, slivers, sunburn, or similar hazards. Loose or ragged clothing or ties shall not be worn while working around moving machinery. At a minimum, employee must wear a short-sleeved shirt and long trousers.

Employees shall wear substantial footwear made of leather or other equally firm material whenever there is a danger of injury to the feet from: falling or moving objects, or from burning, cutting, penetration, or similar hazards. The soles and heels of such footwear shall be of a material that

July 2017

will not create a slipping hazard. Footwear that has deteriorated to the point where it does not provide the required protection shall not be used.

### **17.5 EVACUATE AREA BELOW**

All non-essential personnel below a construction area must be cleared or protection provided.

### **17.6 SECURE THE STORED MATERIAL**

All construction materials and equipment stored on a roof or other exposed areas must be secured against inclement weather conditions. Before the end of the workday, all loose materials must be secured to prevent injury or property damage from falling objects. Caution must also be taken not to overload the roof. Materials shall not be stored within six feet of the edge of the roof unless guards are erected on the roof edge.

### **17.7 TRAFFIC CONTROL**

Where working over or adjacent to a roadway, traffic control measures must be implemented. Employees working adjacent to roadways must wear vests that are highly visible, and have reflective markings. Where working adjacent to transportation aisles, traffic control measures should be reviewed to ensure the safety of the personnel on the job site.

### **17.8 CONTROL FALLING OBJECTS**

Where employees are working over other employees, all tools and equipment shall be secured so that they will not fall. Tethers should be used to tie off tools and equipment. Employees must wear hard hats whenever there is a potential for falling objects. Toe boards and solid floor surfaces without any openings shall be provided to prevent objects from falling through the openings.

### **17.9 DEBRIS CONTROL**

Measures shall be taken to control debris in the construction area. Debris shall not be allowed to accumulate on walking/working surfaces.

### **17.10 RADIO COMMUNICATION OR SAFETY MONITOR**

Wherever work is performed on a roof, lift, or other area where potential for falls exists, a safety monitor or two-way radio communication is recommended.

### **17.11 SAFETY COMMUNICATIONS**

Establish/maintain contact/communication with your Activity Safety Manager or competent person wherever roof top work is being performed and the possibility of adverse weather conditions exist.

### **17.12 LOCK-OUT/TAG-OUT/TRY-OUT**

Where working near energy sources, lock-tag/try-out must be used to eliminate any potential hazards.

### **17.13 CRANE RAIL STOPS**

**Implement the crane rail stops as mandated by the Activity WHE-certifying official.**

### **17.14 CATCH PLATFORM (Falling Object Protection)**

A substantial catch platform shall be installed below the working area of roofs more than 20 feet from the ground to eaves with a slope greater than 4 in 12 (vertical to horizontal and without a parapet). The platform shall extend 2 feet in width beyond the projection of the eaves, and shall be provided with a safety rail, mid rail, and toe-board. This provision shall not apply to workers engaged in work upon such roofs who are protected by a harness attached to a lifeline.

Where work is in progress above workers, a catch platform or other means shall be provided to protect those working below. All workers shall be notified. One completed floor shall be maintained between workers and steel or concrete work above.

#### **Requirements**

- (1) A catch platform shall be installed within six vertical feet of the work area.
- (2) The width of the catch platforms shall equal the distance of the fall, but shall be a minimum of 45 inches wide. The catch platforms shall be equipped with standard guard on all open sides.

### **17.15 EGRESS FALL PROTECTION**

Wherever a fall hazard of 4 feet or greater is encountered by employees moving from one elevated area to another, fall protection shall be provided (for example, utilizing a scissors lift to gain access to a roof or intermediate platform; the employee must be protected when exiting the scissors lift). This can be

July 2017

accomplished by using a double lanyard or a “Y” lanyard. One hundred percent fall protection is required at all times.

**End of Section**

## **18.0 AMERICAN NATIONAL STANDARDS INSTITUTE, ANSI Z359 FALL PROTECTION CODE/STANDARDS**

ANSI is responsible for the development of voluntary consensus standards in the United States. The collection of several ANSI Z359 fall protection standards is termed “Fall Protection Code”. Originally The American National Standards Institute ANSI Z359 Committee developed ANSI Z359.1 as personal fall-arrest system standard. All the testing and criteria was based on complete fall-arrest systems rather than components. In order to harmonize the US FP standards with ISO, Europe, Canada, etc., ANSI is changing the system standards to equipment/component standards. Every component shall have its own standard (i.e. Harnesses, Connectors, etc.) When all product/component standards are finalized and published, ANSI Z359.1 standard will be updated to be the directory for all the standards. Eventually there will be 18 fall protection standards as part of the FP Code.

### **18.1 Completed and Published ANSI Z359 FP Standards**

- ANSI Z359.0 Definitions and Nomenclature Used for Fall Protection and Fall-arrest. This standard is being converted to ASSE Z359.0 document.
- ANSI Z359.01 (approved 15 August 2016, effective 14 August 2017) The Fall Protection Code
- ANSI Z359.2 Minimum Requirements for a Comprehensive Managed Fall Protection Program
- ANSI Z359.03 Safety Requirements for Positioning and Travel Restraint Lanyards
- ANSI Z359.04 Safety Requirements for Assisted- Rescue and Self Rescue Systems, Subsystems and Components
- ANSI Z359.06 Specifications and Design Requirements for Active Fall Protection Systems
- ANSI Z359.07 Certification Testing of Fall Protection Products
- ANSI Z359.11 Safety Requirements for Full Body Harnesses
- ANSI Z359.12 Connecting Components for Personal Fall-arrest Systems
- ANSI Z359.13 Personal Energy Absorbers and Energy Absorbing Lanyards;
- ANSI Z359.14 Requirements for Self Retracting Devices



July 2017

- ANSI Z359.15 Requirements for Single Anchor Vertical Lifelines and fall-arrestors
- ANSI Z359.16 Safety requirements for Climbing Ladder Fall-Arrest Systems

## **18.2 ANSI Z359 Fall Protection Standards under Development**

- ANSI Z359.05 Not Selected
- ANSI Z359.08 Not selected
- ANSI Z359.09 Safety Requirements for Descent Control Devices
- ANSI Z359.10 Not selected
- ANSI Z359.17 Safety Requirements for Horizontal Lifelines for PFAS
- ANSI Z359.18 Requirements for Anchorage Connectors for PFAS (Presently the standard is approved by ANSI and will be published in 2017)
- ANSI Z359.19 Rigid Rail Anchorage Subsystems for Personal Fall arrest System

### **Note:**

**The Requirements for Suspended Rope Access Standard was taken out of the Z359 FP Code/Standards and given a new stand-alone number, Z459.1 Standard. The standard is still part of the FP Code**

The equipment/product requirements prescribed in the completed and published standards above, supersedes the requirements prescribed in ANSI Z359.1 (2007) standard, except the anchorage connector requirements from the Z359.1 (2007) standard are still applicable. Eventually, when the anchorage connector requirements in Z359.18 standard are approved and published, it will supersede the anchorage connector requirements prescribed in Z359.1 (2007) standard. Presently, the Z359.1 (2016) standard is approved and is dependent on Z359.18 standard approval to become effective. The Z359 .1 (2016) is a directory for all the other ANSI Z359 standards.

**End of Section**

## **19.0 REFERENCES**

- 19.1 29 CFR 1926.500, Subpart M, Fall Protection in the Construction Industry.
- 19.2 29 CFR 1910, Occupational Safety and Health Standards.
  - 19.2.1 29 CFR 1910 Walking-Working Surfaces and Personal Protective Equipment (Fall Protection Systems); Final Rule dated 17 November 2016
- 19.3 29 CFR 1915.159, Personal Fall-arrest Systems.
- 19.4 US Department of Labor, OSHA 3124 1993 (Revised) Stairways and Ladders.
- 19.5 American National Standard Institute Standards
  - 19.5.1 ANSI Z359, Fall Protection Code/Standards.
  - 19.5.2 ANSI A10.32 (2012) Personal Fall Protection Used in Construction and Demolition Operations.
  - 19.5.3 ANSI A1264.1 Safety Requirements for Workplace Walking/Working Surfaces and Their Access, Workplace Floor and Wall Openings, Stairs and Guardrail Systems.
- 19.6 Introduction to Fall Protection, J. Nigel Ellis, PHD, CSP, PE, (Third Edition: American Society of Safety Engineers).
- 19.7 US Army Corps of Engineers (USACE), Safety and Health Requirements Manual, EM 385-1-1, current edition.
- 19.8 NAVFAC P300: Management of civil Engineering Support Equipment.
- 19.9 NAVMC DIR 5100.8: Marine Corps Occupational Safety and Health Program.
- 19.10 MCO 5100.29 Series: Marine Corps Safety Program.

### **HOW TO OBTAIN INFORMATION**

1. OSHA Regulations/Standards from OSHA Web Page: <http://www.osha.gov/>
2. DoD employees can acquire at no cost the Construction Criteria Base (CCB) from the National Institute of Building Sciences. CCB is an electronic collection of over 10,000 documents used in building design and construction, including guide

July 2017

specifications, manuals, handbooks, regulations, reference standards and other essential design and construction criteria documents. CCB comprises multiple CDs covering Codes of Federal Regulations, OSHA Standards, Specifications, DOD Manuals and Design Criteria and other relevant information. These CDs are updated quarterly. The P.O.C for Navy employees to order the CCB CDs is:

The CCB website can be accessed at: <http://www.wbdg.org/ccb/ccb.php> Specifications can also be downloaded from the SpecsIntact website (with helpful links, including the CCB website) at:

<http://specsintact.ksc.nasa.gov/>

3. To acquire “Introduction to Fall Protection” (Third Edition) by Dr. Nigel Ellis, Ph.D., the handbook can be purchased for approximately \$85 plus shipping and handling from:

American Society of Safety Engineers (ASSE)  
1800 East Oakton Street  
Des Plains, IL 60018-2187  
Phone: (847) 699-2929

4. ANSI Standards can be purchased from ASSE at the above address.

5. Some of the published ANSI Z359 Standards can be accessed thru DHS from the WBDG

6. This Guide can be found at the following Web Sites:

[https://portal.navfac.navy.mil/portal/page/portal/navfac/navfac\\_ww\\_pp/navfac\\_hq\\_pp/navfac\\_sf\\_pp/navfac\\_sf\\_fall/tab109972/fall%20protection%20guide%2015%20february%202012.pdf](https://portal.navfac.navy.mil/portal/page/portal/navfac/navfac_ww_pp/navfac_hq_pp/navfac_sf_pp/navfac_sf_fall/tab109972/fall%20protection%20guide%2015%20february%202012.pdf)

[http://www.public.navy.mil/navsafecen/Documents/OSH/FP/Shore\\_FP\\_Guide.pdf](http://www.public.navy.mil/navsafecen/Documents/OSH/FP/Shore_FP_Guide.pdf)

**Prepared By:**

**DON Fall Protection Working Group**

**For Questions/comments contact:**

**Basil Tominna, P.E.  
Naval Facilities Engineering Command, HQ  
1220 Pacific Highway  
San Diego, CA 92132-5190  
Phone: Commercial (619) 5332-3041, DSN 522-3041**

**Email: [basil.tominna@navy.mil](mailto:basil.tominna@navy.mil)**

## APPENDIX A

### FALL PROTECTION REQUIREMENTS COMPARISON AMONG VARIOUS OSHA STANDARDS, DON and EM-385 REQUIREMENTS

<p><b>Requirements</b></p>	<p>Navy FP Chapter 13 of OPNAVINST 5100.23 Series and DON Fall Protection Guide</p> <p>Marine Corps Chapter 18, of NAVMC DIR 5100.8, Fall Protection Program</p>	<p>29 CFR 1910</p> <p>General Industry Standard OSHA the Final Rule, 29CFR 1910 Walking working Surfaces and Personal Fall Protection Equipment</p> <p>Subpart D and I</p>	<p>USACE EM385-1-1 (2014)</p> <p>Section 21 Fall Protection</p>	<p>29 CFR 1926</p> <p>Construction Standard</p>
<p><b>Threshold Height FP is required</b></p>	<p>Above <u>4 feet</u></p>	<p>Above <u>4 feet</u></p>	<p>Contractors - Above <u>6 feet</u></p> <p>USACE- Personnel – Above <u>4 feet</u></p>	<p>Above <u>6 feet</u></p>
<p><b>Development of Fall Protection Program</b></p>	<p>Each Activity which has personnel exposed to fall hazards shall establish a managed fall protection program.</p> <p>DON Activities shall conduct fall hazard surveys and prepare survey reports.</p> <p>Navy Activities shall prepare a site specific Fall Protection &amp; Prevention Plan (FP&amp;PP).</p> <p>The FP &amp; PP shall be developed either by a QP or CP.</p>	<p>Not addressed</p>	<p>Every Contractor and USACE – (Owned/Operated permanent facility is responsible for establishing, implementing and managing a fall protection program</p> <p>Contractors having personnel working at heights, exposed to fall hazards and using FP equipment shall develop a site specific Fall Protection and Prevention Plan (FP&amp;PP) and submit it to GDA for review and acceptance as part of APP.</p> <p>The FP &amp;PP shall be developed by either CP or QP.</p>	<p>Not addressed</p>

DEPARTMENT OF THE NAVY FALL PROTECTION GUIDE

July 2017

<p><b>Requirements</b></p>	<p><b>Navy FP Chapter 13 of OPNAVINST 5100.23 Series and DON Fall Protection Guide</b></p> <p><b>Marine Corps Chapter 18, of NAVMC DIR 5100.8, Fall Protection Program</b></p>	<p><b>29 CFR 1910</b></p> <p><b>General Industry Standard OSHA the Final Rule, 29CFR 1910 Walking working Surfaces and Personal Fall Protection Equipment</b></p> <p><b>Subpart D and I</b></p>	<p><b>USACE EM385-1-1 (2014)</b></p> <p><b>Section 21 Fall Protection</b></p>	<p><b>29 CFR 1926</b></p> <p><b>Construction Standard</b></p>
			<p>USACE-Owned/Operated Permanent Facilities having personnel working at heights are required to develop a written FP program and a site specific FP&amp;PP.</p> <p>Each USACE-Owned/Operated Permanent facility shall conduct a Fall Hazard Survey and prepare survey Report at existing buildings or structures.</p>	
<p><b>Preferred Order of Control Measures or Hierarchy of Controls for Fall hazards</b></p>	<p>Elimination</p> <p>Prevention</p> <p>Engineering Controls (design change or using different techniques or equipment (i.e. Work Platforms))</p> <p>Administrative Controls</p> <p>Personal Protective Systems and Equipment.</p>	<p>Not addressed</p>	<p>Elimination</p> <p>Prevention</p> <p>Work Platforms</p> <p>Personal Protective Systems and Equipment</p> <p>Administrative Controls</p>	<p>Not addressed</p>
<p><b>Guardrails</b></p> <p><b>Constructed from wood, structural</b></p>	<p>Consists of top rail, midrail, posts, and toeboard (toeboard as applicable).</p> <p>Top rail shall be <b>42</b></p>	<p>Consists of top-rail, mid-rails, posts, and toe-boards</p> <p>Top edge of railing shall be <b>42 + 3/-</b></p>	<p>Consists of top-rail, midrail, posts, and toeboard.</p> <p>Top rail shall have a vertical height of <b>42 +/-</b></p>	<p>Consists of top-rail and midrail, posts, and toeboard</p> <p>Top edge of railing shall be <b>42 +/- 3</b></p>

DEPARTMENT OF THE NAVY FALL PROTECTION GUIDE

July 2017

Requirements	Navy FP Chapter 13 of OPNAVINST 5100.23 Series and DON Fall Protection Guide  Marine Corps Chapter 18, of NAVMC DIR 5100.8, Fall Protection Program	29 CFR 1910  General Industry Standard OSHA the Final Rule, 29CFR 1910 Walking working Surfaces and Personal Fall Protection Equipment  Subpart D and I	USACE EM385-1-1 (2014)  Section 21 Fall Protection	29 CFR 1926  Construction Standard
steel, pipe or steel cable	<p><u>+/- 3 inches</u> high and withstands a force of <u>200 lbs.</u></p> <p>Mid rails half way between top-rail and walking/working level and shall withstand a force of <u>150 lbs.</u></p> <p>Supporting posts shall be installed at whatever distance is necessary to meet the top rail strength requirement of 200 lbs. without failure</p> <p>Toe-boards shall be <u>3 ½ inches</u> high and shall withstand a force of <u>50 lbs.</u></p> <p><u>For existing Parapet walls with height less than 42 inches will require modification to make the height 42 inches +/- 3 inches.</u></p>	<p><u>inches</u> high and withstands a force of <u>200 lbs.</u></p> <p>Mid rails half way between top railing and walking/working level and shall withstand a force of <u>150 lbs.</u></p> <p>Supporting posts shall be installed at whatever distance is necessary to meet the top rail strength requirement of 200 lbs. without failure.</p> <p>Toe-boards shall be <u>3 ½ inches</u> high and shall withstand a force of <u>50 lbs.</u></p> <p><u>For existing Parapet walls with height less than 42 inches will require modification to make the height 42 inches +/- 3 inches.</u></p>	<p><u>3 inches</u> and withstands a force of <u>200 lbs.</u></p> <p>Mid rails half way between top rail and staging, working platform, or runway and shall withstand a force of <u>150 lbs.</u></p> <p>Posts spaced no more than <u>8 feet</u> apart.</p> <p>Toe-boards shall be <u>3 ½ inches</u> high and shall withstand a force of <u>50 lbs.</u></p> <p><u>For existing Parapet walls with height less than 42 inches, may be used as FP system if the vertical height is a min of 30 inches with a width of 18 inches at top of the wall for a total width of 48 inches.</u></p> <p><u>Commercial off the shelf engineered guardrail systems may be used instead of constructing a system with the materials above and shall be designed to meet the guardrail criteria.</u></p>	<p><u>inches</u> high and withstands a force of <u>200 lbs.</u></p> <p>Mid rails half way between top railing and walking/working level.</p> <p>Posts spaced no more than <u>8 feet</u> apart.</p> <p>Toe-boards shall be <u>3 ½ inches</u> high and shall withstand a force of <u>50 lbs.</u></p>
Work Platforms	When working <u>≥ 4 feet</u> above the	Railing is required when working <u>≥ 4 feet</u>	FP required above <u>6</u>	When working <u>≥ 6 feet</u> above solid

DEPARTMENT OF THE NAVY FALL PROTECTION GUIDE

July 2017

Requirements	<p><b>Navy FP Chapter 13 of OPNAVINST 5100.23 Series and DON Fall Protection Guide</b></p> <p><b>Marine Corps Chapter 18, of NAVMC DIR 5100.8, Fall Protection Program</b></p>	<p><b>29 CFR 1910</b></p> <p><b>General Industry Standard OSHA the Final Rule, 29CFR 1910 Walking working Surfaces and Personal Fall Protection Equipment</b></p> <p><b>Subpart D and I</b></p>	<p><b>USACE EM385-1-1 (2014)</b></p> <p><b>Section 21 Fall Protection</b></p>	<p><b>29 CFR 1926</b></p> <p><b>Construction Standard</b></p>
	<p>ground, the platform must be equipped with a standard guardrail or other fall protection systems.</p> <p>All Types of Suspended scaffolds require railing and single anchor vertical lifeline system.</p> <p>Scissor lifts shall be equipped with standard guardrails. In addition scissor lift shall be equipped with anchorages meeting ANSI Z359, Fall Protection Code/Standards. A restraint system shall be used to prohibit workers from climbing out of, or being ejected from, the platform. It is highly recommended to use adjustable energy absorbing lanyards All suspended scaffolds require railing and single anchor vertical lifeline system.</p>	<p>above the ground level.</p> <p>All work platforms and Scissor lifts shall comply with 1926 Subpart L</p>	<p><u><b>feet for contractors.</b></u></p> <p>For USACE Operated Facilities FP is required above 4 ft.</p> <p>Scaffolds shall be equipped w/guardrail or other FP system.</p> <p>For workers erecting and dismantling scaffolds, if it is not feasible to provide FP, an evaluation shall be conducted by the competent person for fall protection detailing rationale why FP is not feasible and shall be submitted to GDA for review and acceptance as part of AHA.</p> <p>Suspended scaffolds require railing and single anchor vertical lifeline.</p> <p>Self-Propelled Elevating Work Platforms (Scissor lifts) shall be equipped with standard guardrails. And anchorages meeting Z359. A restraint system with a lanyard sufficiently short shall be used. Lanyards with built in EA are acceptable. SRL are also acceptable if permitted by the manufacturer in writing and used in accordance</p>	<p>surface, platforms must be equipped with a standard guard or other fall protection system.</p> <p>Suspended scaffolds require railing and vertical lifeline.</p> <p>Scissor lifts- require railing.</p>



DEPARTMENT OF THE NAVY FALL PROTECTION GUIDE

July 2017

Requirements	<p><b>Navy FP Chapter 13 of OPNAVINST 5100.23 Series and DON Fall Protection Guide</b></p> <p><b>Marine Corps Chapter 18, of NAVMC DIR 5100.8, Fall Protection Program</b></p>	<p><b>29 CFR 1910</b></p> <p><b>General Industry Standard OSHA the Final Rule, 29CFR 1910 Walking working Surfaces and Personal Fall Protection Equipment</b></p> <p><b>Subpart D and I</b></p>	<p><b>USACE EM385-1-1 (2014)</b></p> <p><b>Section 21 Fall Protection</b></p>	<p><b>29 CFR 1926</b></p> <p><b>Construction Standard</b></p>
			<p>with strict compliance w/manufacturer instructions and as determined in writing by the QP. For FP All suspended scaffolds require railing and vertical lifeline.</p>	
<p><b>Covers</b></p>	<p>Install on any hole <b>2 inches</b> or more in its least dimension in walking working surfaces.</p> <p>Shall be capable of supporting, without failure, at least twice the weight of employees, equipment, and materials that may be imposed on the cover at one time.</p> <p>When covers are removed, a guard, attendant or other system shall be provided to protect floor holes or openings.</p>	<p>Install covers on any hole, 2 inches or more in its least dimension.</p> <p>Covers shall be capable of supporting without failure the maximum intended load of employees, equipment and material combined.</p> <p>Provide hinged floor opening cover of standard strength and construction equipped with guardrail or permanently attached.</p>	<p>Install covers on any hole, <b>2 inches</b> or more in its least dimension.</p> <p>Shall be capable of supporting without failure, at least twice the weight of worker, equipment and material combined.</p> <p>Shall be secured and color coded when installed.</p>	<p>Install on any hole, <b>2 inches</b> or more in its least dimension in walking working surfaces.</p> <p>Shall be capable of supporting, without failure, at least twice the weight of employees, equipment, and materials that may be imposed on the cover at one time. No stipulation for removal.</p>
<p><b>Safety Net Systems</b></p>	<p>Shall be installed as close as possible under the walking working surface with unprotected side or edge but not lower than <b>25 feet</b>.</p> <p>Maximum size of mesh opening shall</p>	<p>The final rule refers to the requirements of Subpart M.</p>	<p>Shall be installed as close as practicable under the walking, working surfaces, but not lower than <b>30 feet</b>.</p> <p>Maximum size of mesh opening shall not exceed <b>36 square inches</b> and no longer</p>	<p>Shall be installed as close as practicable under the walking, working surfaces, but not lower than <b>30 feet</b>.</p> <p>Minimum braking strength of outer rope or webbing shall be</p>

DEPARTMENT OF THE NAVY FALL PROTECTION GUIDE

July 2017

Requirements	<p>Navy FP Chapter 13 of OPNAVINST 5100.23 Series and DON Fall Protection Guide</p> <p>Marine Corps Chapter 18, of NAVMC DIR 5100.8, Fall Protection Program</p>	<p>29 CFR 1910</p> <p>General Industry Standard OSHA the Final Rule, 29CFR 1910 Walking working Surfaces and Personal Fall Protection Equipment</p> <p>Subpart D and I</p>	<p>USACE EM385-1-1 (2014)</p> <p>Section 21 Fall Protection</p>	<p>29 CFR 1926</p> <p>Construction Standard</p>
	<p>not exceed <b>36 square inches</b> and no longer than <b>6 inches</b> on any side.</p> <p>Minimum breaking strength of outer rope or webbing shall be <b>5,000 lbs.</b></p> <p>Shall be tested immediately after installation with a <b>400 lbs.</b> sand bag dropped from the same elevation a worker might fall.</p> <p>Specifies limits for safety net extension below the unprotected side or edge.</p>		<p>than <b>6 inches</b> on any side.</p> <p>Minimum breaking strength of outer rope or webbing shall be <b>5,000 lbs.</b></p> <p>Shall be tested immediately after installation with a <b>400 lbs.</b> sand bag dropped from a height at least <b>42 inches</b> above the walking and working surfaces.</p> <p>Inspection: immediately after installation, weekly thereafter and following any repair or alteration. Inspection shall be documented.</p> <p>Specifies limits for safety net extension below the unprotected side or edge</p>	<p><b>5,000 lbs.</b></p> <p>Maximum size of mesh opening shall not exceed <b>36 square inches</b> and no longer than <b>6 inches</b> on any side.</p> <p>Shall be tested immediately after installation with a <b>400 lbs.</b> sand bag dropped from a height at least <b>42 inches</b> above the walking, working surfaces.</p> <p>Specific limits for safety net extension below the unprotected side or edge.</p>
<p><b>Personal Fall Arrest System (PFAS) Requirements</b></p>	<p>Maximum free fall distance of <b>6 feet.</b></p> <p>Maximum arresting force of 1,800 <b>lbs.</b></p> <p>Shall stop the fall with a deceleration distance of less than <b>42 inches.</b></p> <p>Prevent a person from contacting lower level or</p>	<p>For walking/working surfaces, PFAS requirements are addressed in OSHA 29 CFR 1910 Final Rule</p> <p>Maximum free fall distance of <b>6 feet.</b></p> <p>Maximum arresting force of 1,800 <b>lbs.</b></p> <p>Shall stop the fall with a deceleration</p>	<p>Maximum free fall distance of <b>6 feet.</b></p> <p>Maximum arresting force of 1,800 <b>lbs.</b></p> <p>Shall stop the fall with a deceleration distance of less than <b>42 inches.</b></p> <p>Prevent a person from contacting lower level or object.</p> <p>Body belts are not</p>	<p>Maximum free fall distance of <b>6 feet.</b></p> <p>Maximum arresting force of 1,800 <b>lbs.</b></p> <p>Shall stop the fall with a deceleration distance of less than <b>42 inches.</b></p> <p>Prevent a person from contacting lower level or object.</p>

DEPARTMENT OF THE NAVY FALL PROTECTION GUIDE

July 2017

<p><b>Requirements</b></p>	<p><b>Navy FP Chapter 13 of OPNAVINST 5100.23 Series and DON Fall Protection Guide</b></p> <p><b>Marine Corps Chapter 18, of NAVMC DIR 5100.8, Fall Protection Program</b></p>	<p><b>29 CFR 1910</b></p> <p><b>General Industry Standard OSHA the Final Rule, 29CFR 1910 Walking working Surfaces and Personal Fall Protection Equipment</b></p> <p><b>Subpart D and I</b></p>	<p><b>USACE EM385-1-1 (2014)</b></p> <p><b>Section 21 Fall Protection</b></p>	<p><b>29 CFR 1926</b></p> <p><b>Construction Standard</b></p>
	<p>object.</p> <p>Body belts are not authorized.</p>	<p>distance of less than <b><u>42 inches.</u></b></p> <p>Prevent a person from contacting lower level or object.</p> <p>Body belts are prohibited.</p>	<p>authorized.</p>	<p>Body belts are not authorized</p>
<p><b>Fall Protection Equipment Selection Criteria</b></p>	<p>DON activities should use only manufacturer certified equipment and meet ANSI Z359. FP Code/ Standards.</p> <p>Any equipment meeting ANSI A10.14 or Z359.1 (1992, R1999) shall not be used.</p> <p>Only the qualified person for fall protection can make the determination of increasing the free fall distance more than <b>6 feet.</b></p> <p>Frontal D-ring attachment point located at the sternum can be used for fall arrest provided the free fall distance is less than 2 feet and maximum arrest force does not</p>	<p>Employers should obtain comprehensive instructions from the suppliers.</p>	<p>Selection of equipment shall be based on type of work; work environment, weight, size and shape of the worker, type and position/location of anchorage and length of lanyard.</p> <p>Use only equipment meeting ANSI Z359.FP Code/Standards Standard. Any equipment meeting ANSI A10.14 or Z359.1 (1992, R1999) shall not be used.</p> <p>Frontal D-ring attachment point located at the sternum can be used for fall arrest provided the free fall distance is less than 2 feet and maximum arrest force does not exceed 900 lbs.</p> <p>Only the qualified person for fall protection can make the determination of</p>	<p>The type of fall arrest system selected should match the particular work situation and any free fall distance should be kept to a minimum.</p> <p>Consideration should be given to a particular work environment.</p>

DEPARTMENT OF THE NAVY FALL PROTECTION GUIDE

July 2017

<p><b>Requirements</b></p>	<p><b>Navy FP Chapter 13 of OPNAVINST 5100.23 Series and DON Fall Protection Guide</b></p> <p><b>Marine Corps Chapter 18, of NAVMC DIR 5100.8, Fall Protection Program</b></p>	<p><b>29 CFR 1910</b></p> <p><b>General Industry Standard OSHA the Final Rule, 29CFR 1910 Walking working Surfaces and Personal Fall Protection Equipment</b></p> <p><b>Subpart D and I</b></p>	<p><b>USACE EM385-1-1 (2014)</b></p> <p><b>Section 21 Fall Protection</b></p>	<p><b>29 CFR 1926</b></p> <p><b>Construction Standard</b></p>
	<p>exceed 900 lbs.</p>		<p>increasing the free fall distance more than <b>6 feet</b>.</p>	
<p><b>Definition of Qualified Person</b></p>	<p><b><u>Qualified Person for Fall Protection:</u></b> A person with a recognized <b><u>engineering degree</u></b> or professional certificate <b>and</b> with extensive knowledge, training, and <u>experience in fall protection and rescue field</u>, who is capable of performing design, analysis, and evaluation of <b><u>fall protection rescue systems and equipment.</u></b></p>	<p><b><u>Qualified:</u></b> Describes a person who, by possession of a <b>recognized degree</b>, certificate, or professional standing, <b>or</b> who by extensive knowledge, training, and experience, has successfully demonstrated his ability to solve or resolve problems relating to the subject matter, the work, or the project.</p>	<p><b><u>Qualified Person for Fall Protection (New - see Appendix Q):</u></b> A person with a recognized degree or professional certificate <b>and</b> with extensive knowledge, training, and experience in the <b><u>fall protection and rescue field</u></b> who is capable of designing, analyzing, evaluating and specifying <b><u>fall protection and rescue systems.</u></b></p>	<p><b><u>Qualified:</u></b> means one who, by possession of a <b>recognized degree</b>, certificate, or professional standing, <b>or</b> who by extensive knowledge, training, and experience, has successfully demonstrated his ability to solve or resolve problems relating to the subject matter, the work, or the project.</p>
<p><b>Definition of Competent Person</b></p>	<p><b><u>Competent Person for Fall Protection:</u></b> A person designated by the Command to be responsible for the immediate supervision, implementation and monitoring of the fall protection program, who through training knowledge and expertise is capable of identifying, evaluating and addressing existing</p>	<p><b><u>Competent Person:</u></b> Means a person who is capable of identifying existing and predictable hazards in any personal fall protection system or any component of it, t as well as in their application and use with related equipment, and who has authorization to take prompt, corrective action to</p>	<p><b><u>Competent Person for Fall Protection (See Appendix Q):</u></b> A person designated in writing in the AHA by the employer to be responsible for the immediate supervision, implementation and monitoring of the fall protection program, who through training, knowledge and experience in fall protection and rescue systems and equipment,</p>	<p><b><u>Competent Person:</u></b> Means one who is capable of identifying existing and predictable hazards in the surroundings or working conditions which are unsanitary, hazardous, or dangerous to employees, and who has authorization to take prompt corrective measures to eliminate them.</p>

DEPARTMENT OF THE NAVY FALL PROTECTION GUIDE

July 2017

<p><b>Requirements</b></p>	<p><b>Navy FP Chapter 13 of OPNAVINST 5100.23 Series and DON Fall Protection Guide</b></p> <p><b>Marine Corps Chapter 18, of NAVMC DIR 5100.8, Fall Protection Program</b></p>	<p><b>29 CFR 1910</b></p> <p><b>General Industry Standard OSHA the Final Rule, 29CFR 1910 Walking working Surfaces and Personal Fall Protection Equipment</b></p> <p><b>Subpart D and I</b></p>	<p><b>USACE EM385-1-1 (2014)</b></p> <p><b>Section 21 Fall Protection</b></p>	<p><b>29 CFR 1926</b></p> <p><b>Construction Standard</b></p>
	<p>and potential fall hazards and in the application and use of personal fall arrest and rescue system or any component thereof, AND who has the authority to take prompt corrective measures to eliminate or control the hazards of falling.</p>	<p>eliminate the identified hazards.</p>	<p>is capable of identifying, evaluating and addressing existing and potential fall hazards and, who has the authority to take prompt corrective measures with regard to such hazards.</p>	
<p><b>Fall Arrest Anchorages</b></p>	<p>Capable of supporting a minimum of <b>5,000 lbs.</b> attached; or shall be designed, installed and used under the supervision of a qualified person and shall maintain a <b>safety factor of at least two.</b></p> <p>All HLL anchorages shall be designed by a registered PE qualified in designing HLL system</p>	<p>In the Final Rule, references the anchorage strength for personal; FP system as 5,000 lbs. <i>which includes fall arrest anchorages</i></p>	<p>Capable of supporting at least <b>5,000 lbs.</b> per worker attached or designed by a qualified person for fall protection for <b>twice</b> the maximum arrest force on the body.</p> <p>All HLL anchorages shall be designed by a registered PE qualified in designing HLL systems</p>	<p>Anchorages shall be capable of supporting at least <b>5,000 lbs.</b> per employee attached, or shall be designed, installed and used as part of a complete fall arrest system which maintains a <b>safety factor of least 2</b> and under the supervision of qualified person.</p>
	<p>The Gates of Snaphooks and carabiners shall withstand a force of 3,600 pounds in all</p>	<p>The Final Rule prescribes the gates of snaphooks and carabiners shall withstand 3,600 lbs.</p>	<p>The Gates of Snaphooks and carabiners shall withstand a force of 3,600 pounds in all</p>	<p>The gates of snaphooks and carabiners shall withstand a side loading of 220</p>

DEPARTMENT OF THE NAVY FALL PROTECTION GUIDE

July 2017

Requirements	<p><b>Navy FP Chapter 13 of OPNAVINST 5100.23 Series and DON Fall Protection Guide</b></p> <p><b>Marine Corps Chapter 18, of NAVMC DIR 5100.8, Fall Protection Program</b></p>	<p><b>29 CFR 1910</b></p> <p><b>General Industry Standard OSHA the Final Rule, 29CFR 1910 Walking working Surfaces and Personal Fall Protection Equipment</b></p> <p><b>Subpart D and I</b></p>	<p><b>USACE EM385-1-1 (2014)</b></p> <p><b>Section 21 Fall Protection</b></p>	<p><b>29 CFR 1926</b></p> <p><b>Construction Standard</b></p>
	<p>directions</p> <p>Snaphooks and Carabiners manufactured per ANSI Z359.1 (1992-R1999) shall not be used</p>	<p>all around.</p>	<p>directions</p> <p>Snaphooks and Carabiners manufactured per ANSI Z359.1 (1992-R1999) shall not be used</p>	<p>pounds and face loading of 220 pounds</p>
<p><b>Energy Absorbing Single and Y Lanyards</b></p>	<p>The 6 ft. FF Energy Absorbing (EA) Lanyards shall be used when the tie-off point is above the dorsal D ring. The average arrest force on the body shall not exceed 900 lbs.</p> <p>The 12 ft. FF EA Lanyard shall be used when the tie-off point is below the dorsal D ring creating a FF distance of more than 6 feet. The average arrest force on the body shall not exceed 1,350 lbs.</p> <p>The 12 ft. FF EA lanyard may also be used when the free fall distance is less than 6 ft.</p> <p>The length of all EA lanyards used in FA shall not exceed 6 feet.</p>	<p>SRLs that automatically limit free fall distance to 2 feet or less, must withstand a min tensile load of 3,000 pounds</p> <p>SRLs that do not limit the FF to 2 feet or less must be capable of sustaining a min tensile load of 5,000 pounds,</p>	<p>The 6 ft. FF Energy Absorbing (EA) Lanyards shall be used when the tie-off point is above the dorsal D ring. The average arrest force on the body shall not exceed 900 lbs.</p> <p>The 12 ft. FF EA Lanyard shall be used when the tie-off point is below the dorsal D ring creating a FF distance of more than 6 feet. The average arrest force on the body shall not exceed 1,350 lbs.</p> <p>The 12 ft. FF EA lanyard may also be used when the free fall distance is less than 6 ft.</p> <p>The length of all EA lanyards used in FA shall not exceed 6 feet.</p> <p>The 6 ft. and 12 ft. EA Lanyards shall meet the requirements of ANSI Z359.13 Standard.</p>	<p>SRLs that automatically limit free fall distance to 2 feet or less, must withstand a min tensile load of 3,000 pounds</p> <p>No reference to SRLs that do not limit the FF to less than 12 inches</p>

DEPARTMENT OF THE NAVY FALL PROTECTION GUIDE

July 2017

<p><b>Requirements</b></p>	<p><b>Navy FP Chapter 13 of OPNAVINST 5100.23 Series and DON Fall Protection Guide</b></p> <p><b>Marine Corps Chapter 18, of NAVMC DIR 5100.8, Fall Protection Program</b></p>	<p><b>29 CFR 1910</b></p> <p><b>General Industry Standard OSHA the Final Rule, 29CFR 1910 Walking working Surfaces and Personal Fall Protection Equipment</b></p> <p><b>Subpart D and I</b></p>	<p><b>USACE EM385-1-1 (2014)</b></p> <p><b>Section 21 Fall Protection</b></p>	<p><b>29 CFR 1926</b></p> <p><b>Construction Standard</b></p>
	<p>The 6 ft. and 12 ft. EA Lanyards shall meet the requirements of ANSI Z359.13 Standard.</p>			
<p><b>Training</b></p>	<p>Workers exposed to fall hazards from heights and using FP equipment shall be trained by a competent person for fall protection who is qualified in delivering FP training.</p> <p>Retraining shall also be provided as necessary.</p> <p>Refresher training will be provided at an interval determined by the activity.</p> <p>Training of all personnel involved in the FP program including associated trainers shall be in accordance w/ANSI Z359.2.</p>	<p>States that employer must provide training to each employee who uses personal FP equipment.</p> <p>Retraining is required.</p>	<p>Workers exposed to fall hazards from heights and using FP equipment shall be trained by competent person for fall protection who is qualified in delivering FP training.</p> <p>Retraining shall also be provided as necessary.</p> <p>Employer shall verify worker training by a written certification record including name of worker, date of training and signatures of trainer and trainee.</p> <p>Training of all personnel involved in the FP program including associated trainers shall be in accordance w/ANSI Z359.2</p>	<p>States that FP training is required.</p>
<p><b>Horizontal Lifeline</b></p>	<p>Designed prior to use by a registered professional engineer with experience in designing horizontal</p>	<p>Shall be designed and installed as part of a complete fall arrest system which maintains a safety factor of at least <b>2</b></p>	<p>HLL shall be installed and used under the supervision of qualified person for fall protection only, as part of a complete fall arrest</p>	<p>Designed, installed, and used under the supervision of a qualified person and used as part of a complete personal fall</p>



DEPARTMENT OF THE NAVY FALL PROTECTION GUIDE

July 2017

<p><b>Requirements</b></p>	<p><b>Navy FP Chapter 13 of OPNAVINST 5100.23 Series and DON Fall Protection Guide</b></p> <p><b>Marine Corps Chapter 18, of NAVMC DIR 5100.8, Fall Protection Program</b></p>	<p><b>29 CFR 1910</b></p> <p><b>General Industry Standard OSHA the Final Rule, 29CFR 1910 Walking working Surfaces and Personal Fall Protection Equipment</b></p> <p><b>Subpart D and I</b></p>	<p><b>USACE EM385-1-1 (2014)</b></p> <p><b>Section 21 Fall Protection</b></p>	<p><b>29 CFR 1926</b></p> <p><b>Construction Standard</b></p>
	<p>lifeline systems and as part of a complete fall arrest system that maintains a safety factor of at least <b>two</b>.</p>	<p>under the supervision of a qualified person.</p>	<p>system that maintains a safety factor of at least <b>two</b>.</p>	<p>arrest system that maintains a safety factor of at least <b>two</b>.</p>
<p><b>Positioning System Requirement</b></p>	<p>Limit the free fall distance to <b>2 feet</b>.</p> <p>Secured to an anchorage capable of supporting <b>twice</b> the potential impact loading or <b>3,000 lbs.</b> whichever is greater.</p> <p>In addition to positioning system, requires the use of a separate system that provides back-up.</p>	<p>Not addressed in 29 CFR1910 (1970).</p> <p>Addressed only in the OSHA Final Rule</p> <p>The Requirements are similar to 29 CFR 1926, Subpart M.</p> <p>Anchorage for personal FP system must be capable of supporting at least 5,000 lbs. <i>which includes positioning anchorage</i></p>	<p>Be rigged such that a worker cannot free fall more than <b>2 feet</b>.</p> <p>Secured to an anchorage capable of supporting at least <b>twice</b> the potential impact load of a worker's fall or <b>3,000 lbs.</b> whichever is greater</p> <p>In addition to positioning system, requires the use of a separate system that provides back-up.</p>	<p>Shall be secured to an anchorage capable of supporting at least <b>twice</b> the potential impact load of an employee's fall or <b>3,000 lbs.</b> whichever is greater.</p> <p>Shall be rigged such that an employee cannot free fall more than <b>2 feet</b>.</p>
<p><b>Restraint Anchorages</b></p>	<p>Anchorage strength requirement shall be <b>3,000 lbs.</b> or designed by a qualified person for FP for <b>two times</b> the foreseeable force.</p> <p>Restraint system shall be used only on sloped surfaces equal or less than <b>18.4 degrees (4:12 slope)</b></p>	<p>Anchorage strength is not specified in 29 CFR 1910 (197) Standard</p> <p>Anchorage for personal FP systems must be capable of supporting at least 5,000 lbs. <i>which includes Restraint anchorages</i></p>	<p>Anchorage strength requirement shall be <b>3,000 lbs.</b> or designed by a qualified person for FP for <b>two times</b> the foreseeable force.</p> <p>Restraint system shall be used only on sloped surfaces equal or less than <b>18.4 degrees (4:12 slope)</b>.</p>	<p>Anchorage shall have the capacity to withstand at least <b>3,000 lbs.</b> of force or <b>twice</b> the maximum expected force. (*)</p>

DEPARTMENT OF THE NAVY FALL PROTECTION GUIDE

July 2017

Requirements	<p><b>Navy FP Chapter 13 of OPNAVINST 5100.23 Series and DON Fall Protection Guide</b></p> <p><b>Marine Corps Chapter 18, of NAVMC DIR 5100.8, Fall Protection Program</b></p>	<p><b>29 CFR 1910</b></p> <p><b>General Industry Standard OSHA the Final Rule, 29CFR 1910 Walking working Surfaces and Personal Fall Protection Equipment</b></p> <p><b>Subpart D and I</b></p>	<p><b>USACE EM385-1-1 (2014)</b></p> <p><b>Section 21 Fall Protection</b></p>	<p><b>29 CFR 1926</b></p> <p><b>Construction Standard</b></p>
<p><b>Inspection, storage, care, and maintenance of FP equipment</b></p>	<p>Before each use, the user shall carefully inspect the FP equipment. The competent person must inspect the FP equipment at least annually with documentation.</p>	<p>FP equipment shall be inspected prior to each use; employer should obtain comprehensive instructions from the supplier method of inspection, use cleaning and storage.</p>	<p>Equipment shall be inspected by the end-user prior to each use.</p> <p>A Competent person for FP shall inspect the equipment at least once semi-annually and whenever equipment is subjected to a fall or impacted.</p> <p>Competent person's inspection shall be documented.</p>	<p>Personal fall arrest system shall be inspected prior to each use for wear, damage and other deteriorations.</p>
<p><b>Climbing Ladder Fall Arrest System (Requirements (Previously called Ladder Safety system</b></p>	<p>Installed on fixed ladders more than <b>20 feet</b> in length.</p> <p>Anchorage strength <b>3000 lbs.</b></p> <p>Free fall distance shall not exceed <b>2 feet.</b></p> <p>Length of connector between D-ring and LCD shall be <b>9 inches</b></p> <p><b>100%</b> transition at top of ladder.</p> <p>Do not install LCD on ladders having <b>¾ inch</b> rungs unless they are designed to withstand the fall</p>	<p>Installed on fixed ladders more than <b>24 feet</b> in length. (Final Rule)</p> <p>LCD shall meet the design requirements of the ladders which they serve.</p>	<p>Installed on fixed ladders more than <b>20 feet</b> in length.</p> <p>Anchorage strength <b>3000 lbs.</b></p> <p>Free fall distance shall not exceed <b>2 feet.</b></p> <p>Length of connector between D-ring and LCD shall be <b>9 inches.</b></p> <p><b>100%</b> transition at top of ladder.</p> <p>Do not install LCD on ladders having <b>¾ inch</b> rungs unless they are designed to withstand fall forces.</p>	<p>Installed on fixed ladders more than <b>24 feet</b> in length.</p> <p>Capable of withstanding a drop test of <b>500 lbs.</b></p> <p>Free fall distance shall not exceed <b>2 feet.</b></p> <p>Length of connector between D-ring and LCD shall be <b>9 inches.</b></p>

DEPARTMENT OF THE NAVY FALL PROTECTION GUIDE

July 2017

Requirements	<p>Navy FP Chapter 13 of OPNAVINST 5100.23 Series and DON Fall Protection Guide</p> <p>Marine Corps Chapter 18, of NAVMC DIR 5100.8, Fall Protection Program</p>	<p>29 CFR 1910</p> <p>General Industry Standard OSHA the Final Rule, 29CFR 1910 Walking working Surfaces and Personal Fall Protection Equipment</p> <p>Subpart D and I</p>	<p>USACE EM385-1-1 (2014)</p> <p>Section 21 Fall Protection</p>	<p>29 CFR 1926</p> <p>Construction Standard</p>
	forces.			
<p><b>Rescue procedures</b></p>	<p>When using fall arrest equipment, ensure mishap victim can self-rescue or can be rescued promptly should a fall occur.</p> <p>Personnel conducting rescue shall be trained.</p> <p>Anchorage for self-rescue and assisted-rescue shall be identified and selected.</p> <p>Anchorage selected for rescue shall be capable of withstanding static loads of <b><u>3,000 lbs. or 5 times the applied loads</u></b> as designed by qualified person for fall protection.</p> <p>Buddy system (Safety person or spotter) is required.</p>	<p>The employer shall provide for prompt rescue of employees in the event of a fall or shall assure the self-rescue capability of employees.</p>	<p>Requirement to provide prompt rescue to all fallen workers.</p> <p>A rescue plan shall be prepared and maintained.</p> <p>Personnel conducting rescue shall be trained.</p> <p>Anchorage for self-rescue and assisted-rescue shall be identified and selected.</p> <p>Anchorage selected for rescue shall be capable of withstanding static loads of <b><u>3,000 lbs. or 5 times the applied loads</u></b> as designed by qualified person for fall protection.</p> <p>Buddy system (Safety person or spotter) is required.</p> <p>If other methods of rescue are planned (Fire Department) it shall be indicated in the rescue plan.</p> <p>All FBHs shall be equipped w/suspension trauma preventers such as stirrups, relief steps or similar in order to provide short term relief from the effects of</p>	<p>The employer shall provide for prompt rescue of employees in the event of a fall or shall ensure that employees can rescue themselves.</p>

DEPARTMENT OF THE NAVY FALL PROTECTION GUIDE

July 2017

Requirements	<p><b>Navy FP Chapter 13 of OPNAVINST 5100.23 Series and DON Fall Protection Guide</b></p> <p><b>Marine Corps Chapter 18, of NAVMC DIR 5100.8, Fall Protection Program</b></p>	<p><b>29 CFR 1910</b></p> <p><b>General Industry Standard OSHA the Final Rule, 29CFR 1910 Walking working Surfaces and Personal Fall Protection Equipment</b></p> <p><b>Subpart D and I</b></p>	<p><b>USACE EM385-1-1 (2014)</b></p> <p><b>Section 21 Fall Protection</b></p>	<p><b>29 CFR 1926</b></p> <p><b>Construction Standard</b></p>
			orthostatic intolerance.	
<p><b>Warning Line system/Designated Area</b></p>	<p>Consists of wire rope or chains <b>34 - 39 inches</b> high.</p> <p>Tensile strength of the line shall be min <b>500 lbs.</b></p> <p>Stanchions shall be capable of withstanding a force of <b>16 lbs.</b> applied horizontally <b>30 inches</b> from the walking working surfaces.</p> <p>For roofing work, the line shall be erected <b>6 feet</b> away from the edge. For other trades the line shall be <b>15 feet</b> away from the edge.</p>	<p>The OSHA Final Rule uses the designated area which is similar to the requirements of warning line system.</p> <p>For Temporary infrequent work, the line shall be established 6 feet away from the unprotected edge of a roof with a 100% transition from the point of access to the designated area.</p> <p>For other work, the line shall be established 15 feet away from unprotected edge.</p>	<p>Consists of wire rope or chains <b>34-39 inches</b> high.</p> <p>Tensile strength of the line shall be min <b>500 lbs.</b></p> <p>Stanchions shall be capable of withstanding a force of <b>16 lbs.</b> applied horizontally <b>30 inches</b> from the walking working surfaces.</p> <p>For roofing work, the line shall be erected <b>6 feet</b> away from the edge. For other trades the line shall be <b>15 feet</b> away from the edge.</p>	<p>Consists of wire rope or chains <b>34-39 inches</b> high.</p> <p>Tensile strength of the line shall be min <b>500 lbs.</b></p> <p>Stanchions shall be capable of withstanding a force of <b>16 lbs.</b> applied horizontally <b>30 inches</b> from the walking working surfaces.</p> <p>For roofing work, the line shall be erected <b>6 feet</b> away from the edge. For other trades the line shall be <b>15 feet</b> away from the edge.</p>
<p><b>Controlled Access Zones</b></p>	<p>Not addressed in OPNAVINST 5100.23H, The system is addressed in the FP Guide.</p> <p>The system shall not be used as a fall protection method.</p>	<p>Not addressed</p>	<p>Prohibited as a fall protection method.</p>	<p>Allowed by Subpart M.</p>

DEPARTMENT OF THE NAVY FALL PROTECTION GUIDE

July 2017

<p><b>Requirements</b></p>	<p><b>Navy FP Chapter 13 of OPNAVINST 5100.23 Series and DON Fall Protection Guide</b></p> <p><b>Marine Corps Chapter 18, of NAVMC DIR 5100.8, Fall Protection Program</b></p>	<p><b>29 CFR 1910</b></p> <p><b>General Industry Standard OSHA the Final Rule, 29CFR 1910 Walking working Surfaces and Personal Fall Protection Equipment</b></p> <p><b>Subpart D and I</b></p>	<p><b>USACE EM385-1-1 (2014)</b></p> <p><b>Section 21 Fall Protection</b></p>	<p><b>29 CFR 1926</b></p> <p><b>Construction Standard</b></p>
<p><b>Monitoring system</b></p>	<p>Monitoring system shall not be used by itself as a fall protection method. May be used in conjunction with other fall protection system.</p> <p>Not addressed in OPNAVINST 5100.23H. Addressed in the FP Guide.</p> <p>Prohibited as a fall protection system.</p>	<p>Not addressed.</p>	<p>Prohibited as a fall protection system.</p>	<p>Allowed per Subpart M.</p>

(\*) As per OSHA Interpretation Letter

## **APPENDIX B**

### **CALCULATING TOTAL FALL DISTANCE AND CLEARANCE**

#### **B.1 CALCULATING TOTAL FALL DISTANCE**

The total fall distance is the sum of free fall distance and deceleration.

If a worker is connected to an anchorage using a six-foot free fall energy-absorbing lanyard and the anchorage is located 2.5 feet above the worker's Dorsal D ring, what is the total fall distance?

- The maximum free-fall distance is:  
6 ft. (length of FA Lanyard – 2.5 ft.) = 3.5 feet
- The deceleration distance is 4 feet maximum

**The Total Fall Distance is: 3.5 feet + 4 feet = 7.5 feet**

#### **B.2 CALCULATING THE REQUIRED CLEARANCE**

- To determine what is the clearance requirement in Paragraph B.1 above, measured from the walking/working surface to the ground below. Assume the worker's "D" ring location is six feet from his toe at the instant of the worker's fall until he comes to a complete stop. A minimum two-foot safety margin is required below the worker's shoe (After arresting a fall) to the ground below.

The minimum required clearance below the working surface is calculated as follows:

3.5 ft. (Free fall distance) + 4 ft. (deceleration distance) + 1.5 ft. (harness stretch) + 6 ft. (Dorsal D-ring to toe) + 2 ft. (Safety Margin) = 17 ft. "from dorsal D-ring to lower level" – 6 ft. (Dorsal D-ring to toe) = 11 ft. (required clearance from working surface to lower obstruction).

### B.3 Schematics for Calculating Required Clearance

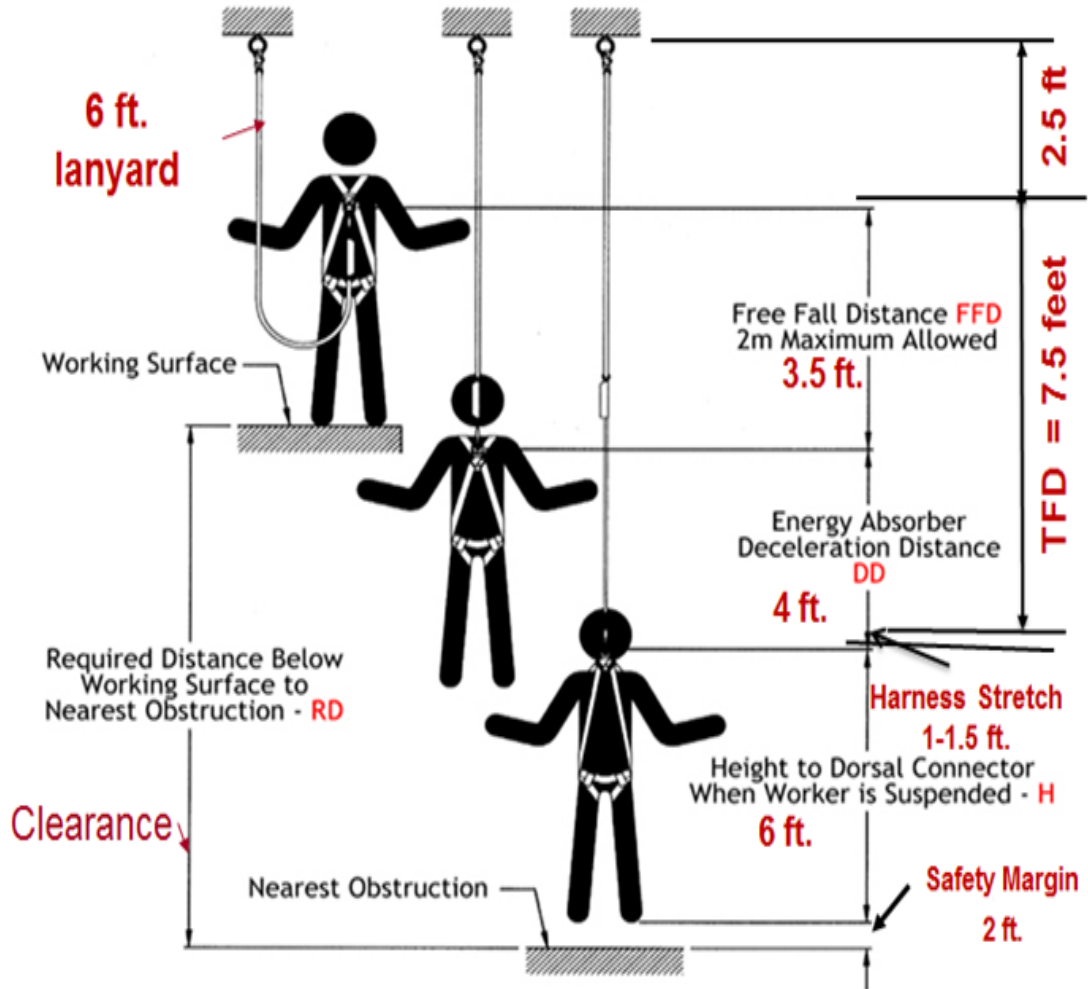



## B.4 Total Fall Distance Schematics

### Total Fall Distance when using 6 ft. free fall EA lanyard

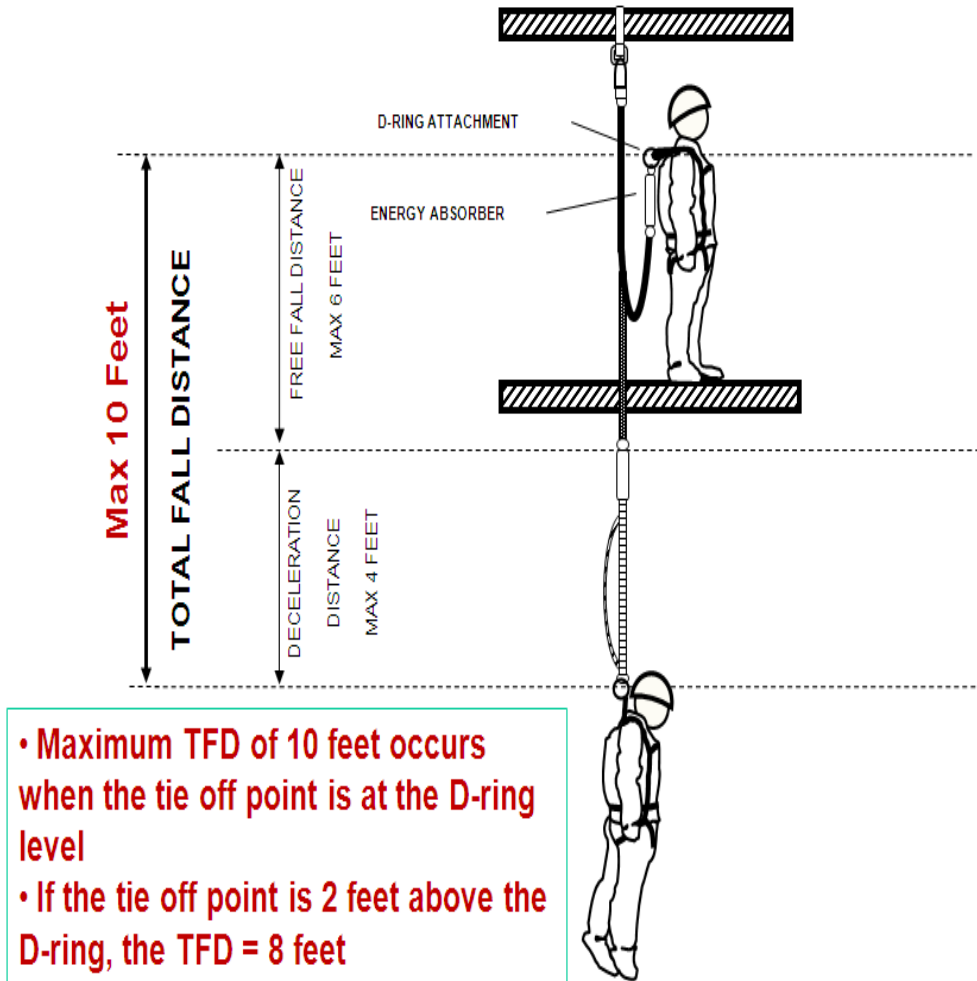

## Total Fall Distance when using 6 Ft Free Fall EA “Y” Lanyard

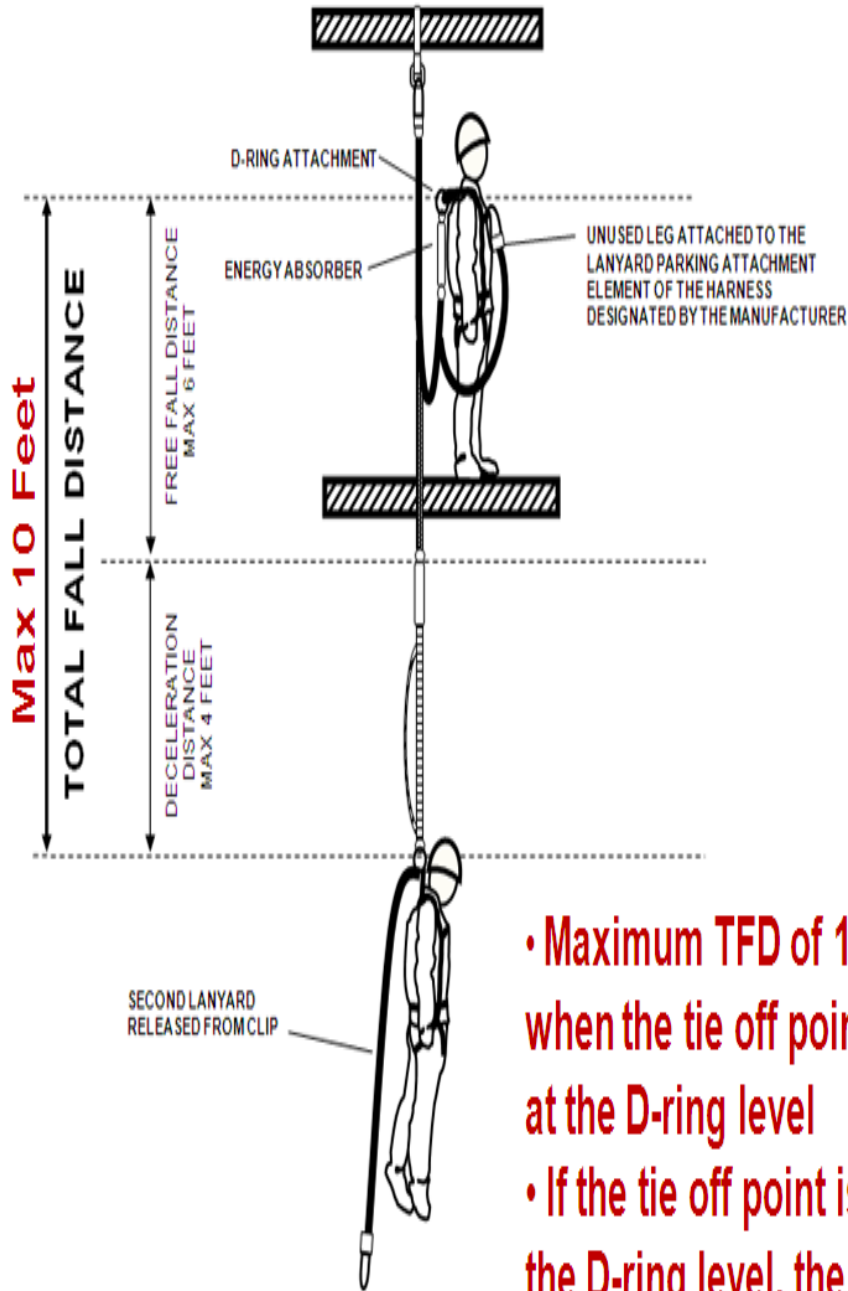

### Total Fall Distance when using 12 ft. Free Fall, Energy Absorbing Single or “Y” Lanyard (TFD for single or Y lanyard is identical)

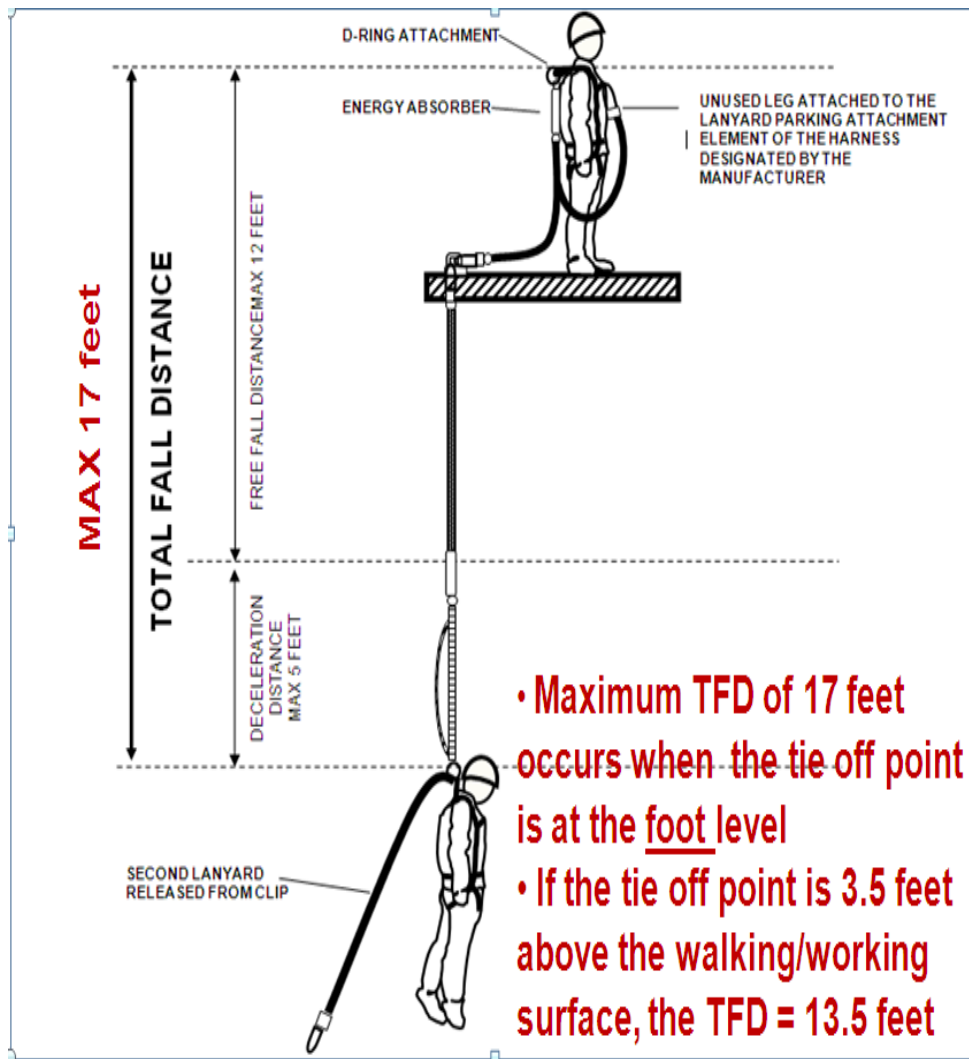

## **APPENDIX C**

### **DISCUSSION, EXAMPLES/PROBLEMS AND SOLUTIONS TO FALL HAZARDS**

The following examples/problems, questions, and solutions to fall hazards are included to help safety personnel, Resident Officers in Charge of Construction (ROICC), design engineers, contractors, and subcontractors to address fall hazard issues and concerns in the workplace, especially during the performance of work:

#### **C.1 PRODUCT OR MATERIAL DELIVERY TO A CONSTRUCTION SITE**

**Question:** Are vendors delivering products or materials to a construction site covered by 29 CFR 1926.500, Subpart M, where the products and material are delivered to a location on the construction site six feet or more above lower level?

**Answer:** Yes, they are required to comply with Subpart M. Vendors and others are considered engaged in construction activities when they deliver products or materials to a construction site that are used during construction work or when they are engaged in an activity that completes the construction work, such as final cleanup of buildings and structures. If the construction contractors picked up the products or materials at the vendor's outlet (store, warehouse, etc.) the vendor, depending upon the type of facility, may not be regulated by 29 CFR 1926.500, Subpart M.

#### **C.2. DELIVERY AND PLACEMENT OF ROOFING MATERIALS**

**Question:** What are the obligations of suppliers of roofing materials when they deliver roofing materials to a construction site and place the material on the roof?

**Answer:** Because the products will be used during construction activities, the suppliers will be required under Subpart M to protect their employees from falls of six feet or more to lower levels when possible. Therefore, employees shall be provided with personal fall-arrest equipment to attach to an anchor point if available. In case of delivering roofing materials, the following is required.

**Gaining Access to a Roof:** Where a vendor or supplier's employee gains access to a roof is a handhold (rope, chain, or other railing) is required to be attached to the conveyor belt in order for the employee to have a support with which to steady him or hers; or a ladder shall be used to gain access to the roof?

**Discussion:** Distribution of Roofing Materials: Once on the roof, the vendor's employee will receive roofing products from a conveyor belt (lift truck or similar equipment), and then distribute the products onto the roof at various locations. During this distribution, OSHA does require the vendor's employees to install anchorage point for fall-protection equipment,

regardless of the slope of the roof or the fall distance. The construction contractor shall establish/identify properly designed anchorages to be used by vendor's employee.

**Additional Discussion:** It is recommended that the employee be tied to an anchorage point at the ridge or the highest point on the roof. The anchorage point can have a post four to five feet high attached to it, so that a self-retracting lanyard or lifeline attachment to the "D" ring will be high enough and won't become a tripping hazard.

### C.3. FALL PROTECTION REQUIREMENTS FOR SCAFFOLDS

**Question:** What type of fall protection equipment will be required for work on scaffolds?

**Answer:** A fall-arrest system, vertical lifeline, and temporary guardrail system will be required on movable or suspended scaffolds. For a scaffold attached to a building or structure (stationary), workers shall use temporary guardrail systems. However, fall-arrest systems or horizontal or vertical lifelines on stationary scaffolds are recommended. A warning-line system is required at the lower level.

### C.4 REQUIREMENTS FOR INSPECTION AND CERTIFICATION PROCESS FOR HORIZONTAL LIFELINE (HLL) SYSTEMS

**Question:** What is the difference between the inspection and certification process?

**Answer:**

**Inspection:** The act of verifying conditions of a system, assembly, or component. Inspection should be per established standards and criteria with a means in place to correct deficient conditions. The inspector shall be trained for the inspection task.

At DON facilities, the horizontal lifelines shall be considered fall protection equipment requiring annual inspection. Inspection of HLL components should include anchorage connectors, lifeline tensioner, in-line energy absorber, thimble, cable, fittings, snaphooks, self-retracting lanyard (shock absorbing lanyards, and full-body harness. Inspection should follow ANSI Z359 Fall Protection Code/ standards, inspection process or OEM instructions, or if produced locally, by the qualified engineer.

**Certification:** The process resulting in documentation that attest in writing, the criteria established for the design of the system and inspection requirements is met. Each activity that installs HLL shall develop a certification process that evaluates the design of the assembly and provides inspection criteria.

**Standards and requirements:** Certifying HLL Systems is carried out by testing or applying proven analytical methods under the supervision of a qualified person.

**The responsibility of certifying HLL lies with the activity that owns or uses the system. Navy activities should take into consideration when selecting or designing HLL systems that these systems will require annual or periodic inspection. The system will also require certification and recertification by a qualified person/engineer. Navy Activities should budget funds for this effort. The frequency of re-certification shall be provided by the designer of the system. The duration of re-certifying the system shall not exceed 5 years.**

### **C.5 RISK OF EXPOSURE TO HIGH WINDS**

**Question:** What is the maximum wind velocity to which an employee should be exposed while performing a task?

**Answer:** Not all fall-protection standards address exposure to high winds; however, 29 CFR 1910.269, titled "Electric Power Generation, Transmission, and Distribution; Paragraph (x) (5)" defines: "High Winds as a wind of such velocity that the following hazards would be present:

- [1] An employee would be exposed to being blown from an elevated location, or
- [2] An employee or employee operating material-handling equipment could lose control of the materials being handled, or
- [3] An employee would be exposed to other hazards not controlled by the standard involved."

**Where work is performed on roofs when the possibility of adverse weather conditions may be present, such as wind, ice, or rain; extra caution must be exercised. The Safety manager or a Competent Person must be consulted where the work is occurring, with consideration of the duration of work, the number of employees, and whom to contact in case of adverse weather.**

Note: Winds exceeding 40 miles per hour or 30 miles per hour where material handling is involved, is normally considered as meeting this hazard-prevention criterion, unless precautions are taken to protect employees from the hazardous effects of the wind.

### **C.6 REQUIREMENTS WHEN ACCESSING AND PERFORMING WORK ON ROOFS**

**Question #1:** Can a "Competent" Person for Fall Protection access a rooftop through a Hatch/door, close the hatch/door and proceed directly to the area of work without a warning line system/designated area, and tie off at destination?

**Answer:** Yes, for Government work (General industry work) per Navy requirements and guidelines and 29 CFR 1910 Final Rule for walking working surfaces, a competent person for fall protection or an end user can enter a rooftop thru a hatch/door, close the hatch/door, and proceed directly to the work location with no fall protection. This however, is only for accessing the work location, but when the work is being performed on HVAC equipment a FP method is required. When only inspecting or investigating mechanical equipment, the work can be performed without FP, if the distance from the unprotected roof edge is more than 6 feet away

from the unprotected roof edge. A warning line system is only used for construction work. For general industry work (i.e. maintaining HVAC equipment); "Designated Area" is used. The requirements for designated area is similar to a warning line system (WLS); in addition safe access to the designated area/warning line system is required from the hatch/door or fixed ladder located at the exterior and must be established by a clear path formed by two lines attached to stanchions. That being said, the first-person-up can access the work location and establish an anchorage or install a designated area, FP is not required during this process. This is called "The First-person-Up". However, when the maintenance work is being performed on the equipment then fall protection is required (this is after installing a FP method). For use of designated area, see chapter 9.0.

**Question #2:** Can a Contractor proceed in the same manner as above?

**Answer:** The answer to the second question is yes; the contractor performing construction work (only the first person up) can proceed in the same manner for accessing the roof or other high locations and said contractor can install a fall protection method or an anchorage without being protected. The first person up has ONLY one job, and that is installing a Fall Protection method. And again, when the work is being performed on equipment FP has to be in place. There are other feasible FP methods that can be used, other than a warning line system or the designated area method, for example; a temporary railing and restraint system if anchorages are available.

**Question #3:** Once "Tied Off" at a designated tie off point, is a Warning Line System still required if the Government/Contractor employee remains tied off until their work is completed?

**Answer:** When a person is tied off using the proper personal FP equipment a warning line is not required, one system is adequate. The only time fall protection is not required is during inspection and investigation work conducted on roofs for the purpose of replacing roofing material or inspecting (i.e. a puddle of water). This applies to Government personnel and contractor worker, and this requirement is included in the FP Guide and EM 385. Such an inspection would fall under the "Construction Exemption". If a person is conducting a roof inspection and investigation work, and said work is within 6 feet from an unprotected roof edge then fall protection is required. Any inspection and investigation work conducted more than 6 feet away from the unprotected side or edge fall protection is not required. Any work involving equipment inspection or maintenance work on roofs (other than roof inspections) falls under the general industry standard and again FP is required.

As a point of note; the EM 385 Section 21 and Navy FP Requirements are almost identical, any differences that exist will only be in the application of the requirements and not the substantive directives.

## **C-7 PERMITTING A CONTRACOR TO USE GOVERNMENT OWNED PERSONAL FALL PROTECTION EQUIPMENT**



**Question:** If a construction contract is let, is it possible to share the government owned fall protection equipment with the contractor which is not a requirement as part of the contract?

**Answer:** Since this requirement is not part of the contract, it is not permitted to let the contractor use government owned personal FP equipment. There is monetary cost associated with the purchasing and use of personal fall protection equipment, and the contractor will make use of such equipment for free. Additionally, because of the liability issue, if the contractor workers are injured they may sue the government.

### **C-8 Guidance for Solar Panel Installations on Roofs:**

**Background:** NAVFAC is preparing contracts to have solar panels installed on roofs of various buildings and facilities, the solar panels will be placed on small racks that will be fastened to the buildings flat roofs. These buildings all have flat roofs and a roof parapet under 42" high. Allowances have to be made for contractor, Solar Panel Workers/ Installers, and Future NAVFAC Maintenance Workers, to get in front of the panels that are the closest to the roof edge. Some have suggested the setback for the solar panels from the unprotected roof edge is 10 ft. others have said 6 ft.

#### **Questions:**

1. What is the distance that the solar panels have to be set back from the edge of the roof? Some have suggested the set back is 10 ft. others have said 6 ft.
2. Does NAVFAC have fall protection guidance for Solar Panel installation?
3. Is it a requirement to install a minimum 42 inches high guardrail systems around the perimeter of the solar panels, at the roof edge or another Scenario is when no guardrail system is planned and the flat roof parapet is under 42 inches high, what is the distance that the solar panels have to be set back from the edge of the roof?

**Answer:** The distance of the solar panels placed near the roof edges depend on what type of equipment are located on the roof, thus requiring maintenance work by Navy personnel. If Navy maintenance personnel do not have to go up on the roof to maintain any equipment or hose down the solar panels, the design of the solar panels can be maximized to cover as much area on the roof as possible. In this case, fall protection will be the solar panels contractor's issue. The contractor has to provide fall protection to his workers. That being said, there is no NAVFAC fall protection guidance regarding solar panels, because it depends on what type of equipment are located on the roof that require maintenance work by Navy personnel and how the solar panel maintenance contract is let.

July 2017

If Navy maintenance personnel are required to go up on a roof to maintain equipment other than solar panels, fall protection is required for them because of the unprotected roof edge. With regard to how far the set back is from the unprotected roof edge, per the DON fall protection guide, paragraph 1.8 and also OSHA states that there is no safe distance from unprotected side of or edge of a roof, or floor. The distance alone is ineffective to protect personnel from unprotected sides or edges; there is no set back requirement. Having a setback of 10 ft. on two sides of a 100 ft. X 100 ft. roof, there would be approximately a 20% loss of the solar panel production capacity. If the setback is 10 feet all around roof, the loss is 36%. This makes a big difference in energy production. Additionally, designated walkways are required if there is a need for Navy maintenance personnel to be on the roof.

Roof perimeter protection is doable, but it is costly, such as raising the parapet wall to 42 inches high or by adding railing on top of the existing parapet wall.

Finally, if NAVFAC maintenance personnel are required to go up on the roof to maintain equipment, there will be a need to provide FP to them. As a FP solution, can we identify or design an anchorage that is conveniently located or can AWP be used? If only the solar panel contractor's workers will be required to go up on the roof to hose down, maintain or replace defective panels, we need to make sure that the contract requires fall protection to be provided by the contractor. One other suggestion, hosing the panels require large quantities of water, recommend providing a hose bib for this work instead of requiring the contractor to deliver the water via a truck. This will be a good investment.

**End of Section**

## **APPENDIX D**

### **MAN OVERBOARD PLAN**

#### **1. REQUIRED EQUIPMENT**

a. **Personal Floatation Devices**: U.S. Coast Guard-approved life jacket or buoyant work vests will be provided for employees working over or near water, where the danger of drowning exists. PFDs (life preservers, life jackets, or work vests) worn by each affected employee shall be United States Coast Guard (USCG) approved pursuant to 46 CFR part 160, Coast Guard Lifesaving Equipment Specifications (Type I, II, III, or V PFD) and marked for use as a work vest for commercial use, or for use on vessels. Prior to each use, personal flotation devices shall be inspected for dry rot, chemical damage, wear, moisture damage, and ultraviolet deterioration that may affect their strength and buoyancy. Defective personal flotation devices shall not be used.

b. **Ring Buoys**: USCG-approved 30-inch ring buoys (life rings/safety buoys) with at least 90 feet of 600 pound capacity line shall be provided and readily available for emergency rescue operations. Distance between ring buoys shall not exceed 200 feet. Prior to each use, personal ring buoys shall be inspected for dry rot, chemical damage, wear, moisture damage, and ultraviolet deterioration that may affect their strength and buoyancy. Defective ring buoys shall not be used.

c. **Lifesaving-Skiff**: At least one lifesaving-skiff shall be available immediately at locations where employees are working over or adjacent to, water where the danger of drowning exists. It is intended that the lifesaving-skiff shall be able to retrieve an employee from the water within no more than three (3) to four (4) minutes from the time of entrance into the water. Additional hazards such as very cold water, strong current, heavy winds, and/or wave conditions shall be noted. The ability to retrieve an employee before injuries are sustained as a result of these additional hazards, and whether it is powered by an inboard engine, will determine the size of the lifesaving-skiff. The lifesaving-skiff shall be properly maintained, ready for emergency use, equipped with oars & oarlocks attached to the gunwales, boathook, anchor, ring buoy with 50 feet of 600-pound capacity line, and two life preservers. (Oars are not required on a lifesaving-skiff powered by an inboard engine.) The lifesaving-skiff shall be manned at all times when employees are working near or over the water. The lifesaving-skiff operator must be trained never to reverse the skiff's engine and approach an employee who has fallen into the water by backing the skiff stern-first, as the propeller may strike the victim. The lifesaving-skiff shall carry a boarding ladder so that the person, if able, can climb into the skiff.

d. **Fall Protection Temporary Guardrail System or Personal Fall Arrest System**: Fall protection shall be provided during construction/erection activities where employees are working 6 feet above lower level surfaces, including water. In cases where 100% fall protection, including the use of temporary guardrail systems or personal fall arrest systems, is

used to prevent employees from falling into the water, the drowning hazard effectively will have been removed; therefore life jackets or buoyant work vests are not required. Ring buoys and a skiff shall be used as a backup in the event of a failure of the operation of fall protection devices, or a lapse in their use (therefore, ring buoys and a lifesaving-skiff shall be provided, irrespective of the fall protection provided on the construction/erection site).

**e. Available Ladder:** There shall be at least one portable or permanent ladder in the vicinity where the work is being performed so that in the event that an employee falls into the water, and if the employee – if not injured, exhausted, or unconscious, will be able to use the ladder to climb out of the water. The ladder shall be of sufficient length so that the employee can step onto the ladder rungs, regardless of the height of the tide.

**f. Lifejacket Rescue Light:** Employees working over (or near) deep water after dark shall have a flashing/strobe or constant beam (visible for at least 1 mile in clear dark conditions) light attached to their PFD. [Note: some PFD lights are activated automatically upon contact with water].

**g. Emergency Whistle:** Employees working over (or near) deep water in foggy conditions shall have attached to their PFD a pea-less omni-directional whistle with at least a 115 decibel volume capacity (at 10 feet). [Note: pea-less whistles have no cork ball or pea that can swell up or stick when immersed in water].

## **2. SAFETY TOOL BOX MEETING**

The *Man Overboard (Person Overboard) Plan* shall be discussed at an employee safety meeting, with all involved employees in attendance, prior to work near or over water. It shall be pointed out at the meeting that employees who fall into the water face a number of dangers, including panic and injury during the fall; and if the fall is into cold water, the employee may experience hypothermia. Quick thinking and coordinated action are essential to an effective rescue. Rehearsal of reaction method(s) is vital to a successful and safe recovery of an individual who falls off a pier, dock, or platform into deep water. *Man Overboard Rescue Procedures* shall be discussed at the Safety Tool Box Meeting. This discussion shall include addressing the visibility conditions (working in a foggy environments or after dark), weather conditions (high wind and/or high waves), and climate conditions (winter months in Northern climates). If the work is being performed near or over cold water, there shall be a discussion on the water survival skills to be utilized to increase the chances for surviving cold water immersion, including the following:

a. Immediately upon falling in the water, try to catch your breath, and become oriented to the surrounding area.

b. Try to get onto the pier or on board the lifesaving skiff, as soon as possible, to shorten the immersion time. (Body heat is lost many times faster in the water than in the air.)

July 2017

c. While afloat in the water, DO NOT attempt to swim unless you are able to quickly reach the pier's safety ladder, or get to the lifesaving-skiff's rescue ladder. (Unnecessary swimming will pump out any warm water between the body and the layers of clothing, and will increase the rate of body-heat loss. Also, unnecessary movements of arms and legs send warm blood from the inner core to the outer layer of the body, resulting in more rapid heat loss.)

### 3. **MAN OVERBOARD RESCUE PROCEDURES**

a. **Shout "Man Overboard"**: The first construction/erection crew member to observe the incident or the person overboard calls out "Man Overboard!" (Even if there is only one person on the shore in the immediate area, shouting "Man Overboard", it may provide reassurance to the person in the water).

b. **Maintain Sight of the Victim**: The person who has fallen into the water must be kept in sight at all times. One employee on shore shall continuously point (open handed) to the individual in the water. (Even the best of swimmers can become disoriented when unexpectedly falling into the water.) Immediate action is of primary importance when a person falls overboard. Every second counts, particularly in windy conditions or cold weather. The condition of the person in the water will dictate the type of recovery procedure used.

c. **Throw Ring Buoy**: A tethered ring buoy immediately shall be thrown to the person who falls into the water. Throw the ring buoy directly in front of the person in the water (ahead of the person in the direction of the moving water); do not throw it directly at the person because it could cause further injury if it hits the individual. The person in the water will be directed to hold onto the line and be hauled in for recovery by the person on the shore tending the line.

d. **Sound a Signal**: Where there are boats in the area, sounding five or more short blasts on a sound signal, horn, or whistle (e.g., hand-held emergency whistle) will alert boats in the area that a danger exists (i.e., a person is overboard). (Boats in the vicinity may not be aware of what the signal means, but at least they will realize something unusual is happening.)

e. **Call 911**: Call 911 by using a mobile or land phone, or contact emergency personnel by Marine VHF radio. Assume that the person who is in the water is suffering from shock, may be unconscious, and possibly injured.

f. **Lifesaving-skiff**: If the person who falls into the water easily and quickly cannot be pulled via the ring buoy to an available ladder to climb out of the water, or if the person who falls into the water is weak, injured, exhausted or unconscious; then the lifesaving-skiff shall proceed to rescue the person in the water. If, however, wind, wave conditions, maneuverability of the skiff, or maneuvering space restriction prevents the safe approach to the individual in the water by the lifesaving-skiff; then rescue by a surface swimmer shall be considered.

**g. Water Rescue by Swimmer:** Employees who attempt a rescue shall be counseled that they are to go into the water after the victim ***only*** as a last resort. Surface swimmers are any swimmers not trained as rescue swimmers. Their training is accomplished through Personnel Qualification Standard (PQS). They are deployed from floating units, piers, or the shore. A surface swimmer must wear a PFD (with dry suit or wet suit in cold water) and a swimming harness with a tending line. Another person will tend the harness whenever the swimmer is in the water. When the surface swimmer has reached the unconscious or injured victim and has obtained a secure hold on the person, the person tending the harness line will haul both back to the shore. (Water rescue by a swimmer without a personal floatation device should never be attempted unless the person doing the rescue has had advanced training in lifesaving. Too often the would-be rescuer becomes another drowning victim.)

**h. Getting Victim onto the Shore or into the Skiff:** Getting the person onto the shore (pier) or onto the skiff can be difficult. A person is light in the water due to buoyancy; however, once free from the water the person becomes “dead weight.” Keep this in mind and be especially careful when recovering injured persons.

(1) Where the pier has a ladder to the water and/or the skiff has as a boarding ladder and the person in the water is able to climb out, use it if it is safe to do so.

(2) If the person in the water needs assistance, two people could be used to pull the person up out of the water and onto the pier or the lifesaving-skiff, by each placing a hand under the person’s armpit or the use of a recovery strap (the strap should cross the chest, pass under each arm, and up behind the head). The rescuers should physically pick the person straight up out of the water to a sitting position on the pier or on the gunwale of the lifesaving-skiff. Be careful not to drag the person’s back across the rail.

(3) If the victim is unconscious or exhausted, and the person is corpulent, a form of lifting gear with appropriate lifting slings and necessary rigging needs to be considered. A short rope or strap with its ends spliced to form a loop used in conjunction with a block and tackle rigged on the end of a halyard would make it easier for a heavy casualty to be lifted onto the pier.

**End of Section**

## **APPENDIX E**

### **GUIDANCE DOCUMENT-DESIGN CONSIDERATIONS FOR MANAGEMENT OF FALL HAZARDS**

#### **INTRODUCTION**

Architects, engineers, and other designers, whether DON or contract (A/E) personnel, can play a major role in assisting contractors to protect their workers during the construction phase, and also in making it safe to manage fall hazards associated with working at heights on existing buildings and facilities during the maintenance phase. Designers should play a major role in making it easier and safer to manage fall hazards associated with working at heights.

Falling from height is the most common cause of fatal mishaps on construction sites, and one of the leading causes in general industry. Often mishaps occur because fall protection had either not been provided, or used incorrectly.

In many cases, the design is such that the provision of fall protection is either not practicable, or requires workers to work beyond the confines of the protection zone provided. In such circumstances, designers should attempt to prevent the development of conditions in which an accident can happen.

Nevertheless, in many instances work at height is necessary and cannot be avoided. Even so-called low-rise buildings and structures have some components or equipment on roofs (e.g. HVAC equipment, chimneys, penetrations, etc.) that require working at heights.

Information from mishap reports show that there are five main reasons why workers fall to lower level. These are:

- a) Poor workplace design;
- b) Means of access collapsed (e.g., scaffolds, ladders etc.);
- c) The worker was required to work beyond the confines of the protection provided; thus exposing him or her to fall hazards;
- d) Edge protection was inadequate, not provided, or of poor design or construction; or
- e) Restrictions placed on the movement of workers did not accommodate the construction activities, and hence were ignored.

It is of the utmost importance for architects and engineers to know how a contractor will build or construct a building or facility, and to understand the required subsequent maintenance work. Knowledge of construction and maintenance operations will help architects and engineers to design safer buildings and facilities, and to specify the proper materials and equipment. These efforts will help contractors during construction operations, and protect DON and contract personnel who perform maintenance work after construction is complete.

**Management of other hazards is also addressed in this guidance document because the hazards are either directly or indirectly related to fall hazards.**

**End of Section**



# 1. MANAGEMENT OF FALL HAZARDS DURING CONSTRUCTION

## (DESIGN FOR CONSTRUCTION SITE SAFETY)

### 1.1 MANAGING FALL HAZARDS DURING ROOF CONSTRUCTION

Roofs are hazardous places to work, because they are at height and utilize roofing materials which are lightweight and often fragile, and may deteriorate over time due to weather exposure and other environmental factors. While work on roofs is an infrequent activity, the risk of a fatal or serious mishap is very high. Designers who see roofs only as a means of making the building water-tight may exacerbate the situation. They may forget that people have to construct roofs and maintain them. Consequently, inadequate consideration may be given to worker safety. Workers often are killed or injured when falling from heights; therefore, designers should consider alternative designs to ensure that repeated roof work can be eliminated or significantly reduced. Falls from roofs can occur either from an unguarded edge or through a fragile surface (premature collapse).

The following considerations can make A/Es aware of these issues, and may provide information on how they can assist contractors to make roof work safer by design.

#### 1.1.1 FALLS FROM UNGUARDED EDGES

Roof construction can create an advancing unprotected leading edge, and the risk from falling from this edge; therefore, designers should consider the following provisions to protect the workers from this hazard:

- a) Provide effective anchorage points for attachment of safety nets;
- b) Where (a) is not possible, make provision for anchoring a personal fall arrest system to structural members with sufficient strength; and
- c) Optimize the locations of close-under-the-roof obstructions (i.e. service ducts that are in the deflection zone or path of fall arrest equipment); and
- d) Consider the provision of parapets. This will eliminate unprotected roof edges for some construction workers and for those who perform subsequent maintenance work.

#### 1.1.2 FALLS THROUGH ROOFS

Specify roofing substrate materials of appropriate strength and rigidity. For other than temporary structures, avoid materials subject to rot or damage by insects or other vermin. Specify plywood sheets (do not specify particle board for roofing material).

### **1.1.3 FALLS CAUSED BY PREMATURE COLLAPSE OF STRUCTURES**

Individual plywood sheets do not weigh a lot. However, the weight of a stack of sheets is significant. Therefore, ensure that the roof structure can carry these loads and make sure the roof decks can provide adequate support for workers as they are being installed.

### **1.1.4 PROVIDING FOR CRANE PLACEMENT OF MATERIALS**

Site the building to ensure that there is enough space to locate and use a crane so that every part of the building is within its lifting capacity.

### **1.1.5 MINIMIZING THE RISK OF MATERIAL MANUAL HANDLING**

Decking materials must be maneuvered into position by contractor's workers. Try to limit their size.

### **1.1.6 CONVEYING FALL HAZARD INFORMATION TO THE CONTRACTOR**

After completing the design, designers shall provide contractors with sufficient information to allow them to control residual or other hazards, including information about the issues discussed above.

## **1.2 MANAGEMENT OF FALL HAZARDS IN OTHER PARTS OF BUILDINGS OR STRUCTURES**

### **1.2.1 DESIGN CONSIDERATIONS WHEN WORKING AT HEIGHTS**

Designers have a major role in providing safe design, and in eliminating or preventing the need to work at height, to the extent possible. For example:

- a) Excavation for retaining walls can be designed as contiguous bored piles installed from existing ground level. This would eliminate shuttering and pouring concrete at height.
- b) Trusses and other structural members should be designed to allow pre-assembly and lifting (this also will reduce construction cost by eliminating field assembly).
- c) Floor height in buildings should be designed so that temporary support structures needed during construction can be installed from the floor below; however, if work at height cannot be avoided, designers should aim to assist the Contractor by applying the following control measures:

- 1) Facilitate the provision of fall prevention measures to make temporary work at height during construction safe (e.g., install temporary guardrails at the perimeter of the structure prior to erection);
- 2) Facilitate the use of temporary access equipment (e.g., scaffolds).
- 3) Facilitate the provision of fall arrest measures.
- 4) In addition, the design should eliminate any requirement for personnel to work outside the confines of the edge protection.

### **1.2.2 FACILITATING THE PROVISION OF FALL PROTECTION MEASURES**

Workers are most vulnerable when working near the perimeter of a structure or when working close to leading edges inside the structure. The design should limit the exposure of workers to such fall hazards. As an example, designers can:

- a) Specify composite flooring which will support erection loads, to allow placing of formwork immediately after the support frame is complete. Designers should minimize the need for people to work at height to erect false-work to temporarily support floors. (False-work is any temporary structure built to provide support for permanent structure until it becomes self-supporting.)
- b) Specify attachments for temporary edge protection on perimeter members (e.g., tubes welded to structural steel members or securely attached to cast concrete members);
- c) Position splices for steel columns at approximately 42 inches above floor level. This will allow splicing from a completed protected floor, and will also serve as guardrails;
- d) Consider specifying pre-cast concrete for slabs and other components of the building and structure, potentially to reduce the time and expense of working at height;
- e) Specify permanent stairways to be installed early in the construction phase to avoid the need for temporary access.

### **1.2.3 FACILITATING THE PROVISION OF SAFE AND TEMPORARY ACCESS TO WORK AT HEIGHT DURING CONSTRUCTION**

Temporary access equipment (e.g., scaffolds and towers) need to be tied to the building or structure at regular intervals; to provide restraint against buckling and overturning. This is particularly important with façades where glazing predominates.

### **1.2.4 FACILITATING THE PROVISION OF SAFETY NETS, FALL ARREST AND OTHER PROTECTIVE MEASURES**

The most commonly used fall protection systems are safety nets and personal fall arrest systems.

### 1.2.4.1 Safety Nets

When safety nets are considered as a fall protection measure, designers should reference ANSI A10.11 Standard regarding the use, testing and certification requirements of safety nets.

General considerations include:

- a) Comparison of the capacities and applications of safety net systems offered by several suppliers before developing the design;
- b) Where safety nets are to be attached to a structural grid, designers should:
  - i) Check that the grid will resist lateral loads, especially when nets are attached to steelwork in composite construction or to purlins in roof work;
  - ii) Ensure that the net installation attachment points are located as close as practicable under the walking working surface to minimize the distance of the fall. In addition, ensure that the safety net can deflect safely when a worker falls into it.
- c) Consider restricting service runs to limited areas such that they cannot obstruct a fall into a net or prevent the net from deflecting;
- d) Consider restricting the net area enclosed by the grid.

Safety nets are often installed from mobile elevating work platforms; therefore, designers should allow for the concentrated loads applied by the platform wheels/outriggers of the equipment on the ground.

### 1.2.4.2 Fall Arrest System

Fall arrest systems must be attached to suitable and sufficient load-bearing anchors; therefore, contractors should:

- a) Provide anchorages capable of supporting 5,000 lbs., or designed for twice the maximum arrest force;
- b) Be aware that:
  - i) Energy absorbing lanyards should be as short as possible (Six feet or less),
  - ii) Impact of fall forces are minimized when the anchorage is located above the worker;
  - iii) Lanyards can be cut by sharp edges (Chafing material will be required);

iv) The available clearance below the work surface is very important. Depending on the anchorage location and the type of energy absorbing lanyard used, the required clearance has to be determined to prevent a worker from contacting lower level or an obstruction during a fall.

c) Show clearly where these anchorages are located;

d) With horizontal lifelines the forces imparted by a fallen worker on the anchorages may be greatly in excess of 5,000 lbs.; therefore, the manufacturer of the horizontal lifeline system should be consulted for advice.

### 1.2.4.3 Other Control Measures

For steel erection, designers should consider the provision of holes in flanges of columns and beams, where:

a) Holes in columns should be drilled at 21 and 42 inches above the beams, so that a cable can be strung between the columns and used as a temporary guardrail system;

b) Holes in beams should be at a maximum of 6 feet on centers.

For pre-cast concrete, designers should specify anchorages and requiring the following information:

a) Depth of embedment in concrete;

b) Anchorages should be located as far as possible behind the leading edge.

## 1.3 MANAGEMENT OF HAZARDS ASSOCIATED WITH THE ERECTION OF STRUCTURES

Designers can play a major role in making it easier to manage fall hazards associated with erecting structures. Some designers have been found to have a narrow view of design, that it requires structural analysis followed by detailed design. This is not adequate, the designers need to take into consideration that something will be erected or constructed followed by how it will be maintained and, in due course, demolished.

### 1.3.1 HAZARDS ASSOCIATED WITH STRUCTURAL ERECTION

The erection of structures requires contractor's workers to work on partially complete structures, where they are exposed to hazards associated with instability and working at height. In addition:

a) Workers often have to work in proximity with equipment or machines (e.g., cranes) which are used during the erection of the structures;

- b) Sometimes, unplanned work exposes them to health hazards, which arise from the application of a remedial process (e.g., cleaning and then painting corroded steel); and
- c) Delays in construction could mean that many tradesmen are working in close proximity, under or above others.

Therefore, hazards associated with erecting structures and associated temporary works may be summarized as including:

- a) Temporary instability;
- b) Falls from height;
- c) Lifting: Overturning of cranes;
- d) Working on or near fragile or unstable materials;
- e) Handling heavy unwieldy loads;
- f) Collapse of temporary equipment;
- g) Danger to adjacent properties.

### **WHAT SHOULD DESIGNERS DO?**

In order to prevent, (as much as possible), workers' exposure to fall hazards, designers should consider the following:

#### **1.3.2 DESIGNING TO MINIMIZE TEMPORARY INSTABILITY**

Structures in their temporary state could become unstable for many reasons, these may include:

- a) Omission of temporary support work, which usually occurs when the design is out-of-the-ordinary and usual erection practices are insufficient. Examples of out-of-the-ordinary designs may include the following:
  - i) Slender rafters, which require additional bracing until the strength of the roof is adequate;
  - ii) Portal frames where the cladding contributes to sway stability;
  - iii) Long-span structural members, which require bracing until another one is connected (e.g., some bridge beams).
- b) The partially-erected structure is inherently unstable, which could occur when:
  - (i) It is stabilized by other (remote) parts of the permanent parts or components (e.g., shear walls, shear cores or adjacent structures);

- (ii) Provision for lateral stability is either by asymmetrical bracing or contributed by other structural members to be added later (e.g., cladding);
  - (iii) Due to design, the structure is subjected to significant un-anticipated construction loads (e.g., when the assembled roof is being lifted or when masonry walls are loaded too soon);
  - (iv) A structural member has inadequate seating when placed on another member in the temporary state, because erection tolerances add up unfavorably, such as:
    - Pre-cast slabs on narrow-flange beams,
    - Purlins on main rafters,
    - Beams erected on corbels.
  - (v) Structural members in isolation cannot sustain normal erection loads such as:
    - Pinned-base columns under lateral loads from ladders,
    - Long-span beams and trusses
- c) Temporary support structures are removed prematurely, which usually occurs when a structure is apparently complete, such as where:
- (i) Composite beams and panels support “green” concrete,
  - (ii) Portal frames rely on ties into the floors to carry significant horizontal thrust at their base;
  - (iii) When the guying systems are the supporting columns.

While it is desirable for designers to eliminate these hazards by design, at a minimum the designers should:

- a) Advise the Contractor that these hazards exist; and
- b) Inform the contractor about design assumptions and design forces, such as the magnitude of construction loads allowed, portal base, horizontal thrusts, etc.

### **1.3.3 DESIGN TO MINIMIZE FALLS FROM HEIGHT**

During the erection of structures, workers often find themselves in precarious positions (e.g., straddling unattached beams, working towards an open unprotected edge, etc.). Although these hazards are the liability of contractors on site, designers should give consideration to details, which could help to limit workers’ exposure to fall-hazards, or provide other prevention or control measures, for example by:



- a) Contacting multiple suppliers of temporary edge protection, and discussing with them methods for features of their products to be integrated into the design of the permanent components of the structure;
- b) Designing structural components or elements which will allow the attachment of anchorages for using fall arrest/restraint systems or safety nets, where appropriate;
- c) Accounting for erection and manufacturing tolerances to minimize the need for vigorous material manhandling while slung at height, such as: placing concrete slabs on steelwork or erecting steel beams between columns;
- d) Specifying a good quality sub-base for concrete slabs on ground, which would carry the loads from the necessary cranes and mobile platforms required for the erection of the building envelope;
- e) Removing the need for some work at height (e.g., getting rid of sag bars for purlins).

#### **1.3.4 DESIGN TO MINIMIZE HAZARDS WHEN USING CRANES**

This usually means being aware of the conditions under which a crane could overturn or collapse. While it is not always possible to limit the weight of components: members or frames, or the radius over which they have to be lifted into position, designers should give consideration to the following:

- a) Cranes need working room; therefore, avoid heavy lifts or large lifting radii on congested sites;
- b) The radius of a lift limits the weight that a mobile crane can lift; even moderate weights lifted over a large radius could create a lifting hazard;
- c) It is always helpful to know the weight of the loads being lifted. Therefore, inform the crane operator about maximum loads of components;
- d) It is essential to know where the center of gravity is, especially if it is not in the center of the load;
- e) Identifying lifting points is always helpful;
- f) Cranes need good foundations therefore do not specify designs loads which require heavy lifting on sites where the soil is poor;
- g) On exposed sites, the effect of wind velocity on assemblies with large effective areas could create a lifting hazard;

- h) Long-span and large section beams have a significant momentum when they start to swing.

Where the design includes heavy or moderately heavy loads to be lifted over a large radius, discuss the options with the manufacturer and supplier of the crane to be used.

### **1.3.5 WORK ON OR NEAR FRAGILE OR WEAK MATERIALS**

This is a problem largely, but not solely, associated with roofing. Designers should specify only non-fragile and strong components and assemblies.

### **1.3.6 HEAVY OR UNWIELDY LOADS**

This is a problem of specification. If lighter weight alternatives exist, specify them instead. For example:

- a) Use light weight concrete blocks or bricks instead of heavy ones. Where heavy blocks are unavoidable (i.e. for acoustics, specify half size blocks to reduce the weight).
- b) Where steel sections must be lifted manually (e.g., some lintels), consider the most appropriate sections which satisfy the loading requirements.
- c) Where standard details govern the specification, discuss the possibility of moving heavy objects with the lift equipment.

Where it is not possible to specify less-massive alternative products, inform the contractor about their weight, or investigate whether or not mechanical installers exist, and design these components to be compatible with their use. For example, machines are available to install heavy glazing units and concrete curbs.

Even “light weight” components can be unwieldy and difficult to manhandle if their shape is unusual or the center of gravity is far away from the geometric center. Therefore designers should consider:

- a) Providing seating cleats for such members;
- b) Incorporating lifting points, which allow vertical and horizontal members to be dropped into position vertically and horizontally.

### **1.3.7 COLLAPSE OF TEMPORARY WORK STRUCTURES**

While it is not the duty of architects and engineers designing the building or structure, it is recommended that consideration be given to the design of temporary support structures; especially when the design incorporates components which could be used to stabilize the temporary support structures (e.g., by recommending methods for tying the scaffold to the structure).

### **1.3.8 DESIGN TO MINIMIZE DANGER TO EXISTING ADJACENT STRUCTURES**

Sometimes, the location of existing buildings or structures can limit or make erection processes difficult. For example:

- a) Noise and ground vibrations may not be acceptable (e.g., near hospitals);
- b) Excavation may not be possible close to canals or other watercourses;
- c) Crane operations may be restricted by a number of constraints. Designers should include measures into the design to protect adjacent structures.

## **1.4 MANAGING HAZARDS DURING STEEL ERECTION**

Erecting steelwork can expose workers to several fall hazards. During construction, it is the contractor's duty and responsibility to protect workers exposed to such hazards. However, designers can help contractors by taking into consideration other alternative measures, which will reduce workers' exposure to these hazards.

Designers should be aware that the state-of-the-art in erecting steelwork is changing. Increasingly, it is being erected using work platforms, and designers should be aware of how this might affect their design or using horizontal lifeline systems on pre-installed beams (such as using stanchions).

### **1.4.1 HAZARDS ASSOCIATED WITH ERECTING STEELWORK**

The erection of steelwork requires people to work on partially complete structures, and usually the work is performed at height. In addition, steel erectors are often exposed to other hazards associated with:

- a) Working in proximity to machines or equipment (e.g., cranes);
- b) Unplanned work (e.g., remedial processes that could expose workers to health hazards); and

July 2017

- c) Program delays, which could result in trades' working near, beneath, or above others.

The hazards associated with erecting steel structures and working on associated temporary works may be summarized as follows:

- a) Temporary instability;
- b) Falls from height – people and objects;
- c) Lifting components (exacerbated by site constraints);
- d) Handling heavy loads; and
- e) Collapse of temporary equipment or inadequately connected structures.

### **WHAT DESIGNERS SHOULD DO**

Designers should give consideration to measures which either will remove or lessen or minimize these hazards.

#### **1.4.2 DESIGN TO MINIMIZE TEMPORARY INSTABILITY**

Usually, steelwork is erected piece-by-piece. Therefore, at any time there is a chance for frame instability. However, the risk of instability can be reduced by some fairly simple measures, which include:

- a) Provide bracing between the first two bays to be erected, to form the basis of a braced erection;
- b) Checking all structural steel members for assumed erection loads. Particularly vulnerable structural members may include:
  - i) Long-span (slender) members;
  - ii) Floor beams, especially when they are part of a composite system, due to:
    - Stacks of profiled steel forms;
    - Torsional effects of placing concrete panels on one side of the flange;
    - Concrete discharged in a heap; or
    - Other foreseeable storage;
  - iii) Roof beams, especially portal rafters, for stacks of profiled roofing assembly materials;

- c) Design bracing to be symmetrical;
- d) Ensuring that plan bracing connects into vertically braced bays;
- e) Design columns as free-standing cantilevers during erection, to resist short-term erection loads such as wind loads, ladder lateral forces, etc., meaning that pinned columns (e.g. Two bolt connections) may not be adequate;
- f) Ensuring that design effective lengths can be achieved by assumed construction techniques;
- g) Ensuring that slender members can resist the compression imposed by lifting/rigging slings (e.g. the components of the sling forces). If there are restrictions on sling angle, inform the contractor, to allow for the design of the lifting points;
- h) Consider the worker's fall arrest forces;
- i) Design bases for portal and arch-type structures to resist the lateral thrusts developed at their bases;
- j) Where aerial work platforms are to be used, their loads on the partially erected structure must be accounted for.

After performing these checks, designers should:

- a) Inform the contractor about all design assumptions including erection load allowances, lateral stability when it is by other means (e.g., diaphragm action of floors or cladding, or by shear cores or when symmetry cannot be achieved), and the magnitudes of the forces.

### **1.4.3 DESIGN TO REDUCE THE HAZARD OF FALLING FROM HEIGHT**

Falls from height can occur from any unprotected side or edge. Designers should give consideration to measures which would protect workers from fall hazards, by reducing the time they have to spend at height and by designing provisions for worker protection.

To reduce the time workers spend at height, designers could:

- a) Design to maximize prefabrication (i.e. portal frames to be erected flat and lifted to vertical);
- b) Limit the number of bolts in connections;
- c) Minimize components (e.g. purlins);
- d) Design buildings with fewer members;
- e) Use concrete floor construction in preference to profiled steel forms, which need bolting down.

Workers are most vulnerable when the steel is ready to receive subsequent components (*e.g.*, concrete floor units, profiled steel formwork, roof assemblies, etc.), which create an advancing unprotected leading edge. Therefore, designers should consider means for attachment of the fall arrest system. For example, designers could:

- a) Design parapets at the roof edges having minimum height of 39 inches (instead of 30 inches, for example), which would act as compliant guardrail. This increase in height to 39 inches will increase the wind load at the base of parapet. The parapet has to be evaluated structurally because the wind stresses at the base will be proportional to the square of the height.
- b) Provide holes in column flanges at least 6 feet above floor steel level for connecting the lanyards to the anchorage which is capable of supporting 5,000 lbs. force;
- c) Specify the provision of anchorages in sequential components, (*e.g.*, concrete units and profiled steel forms);
- d) Ensure that the structural steel members can resist the loads from safety net anchorages, and specify net anchorage components;

In addition, access to the work place at height, should, wherever possible, be provided by permanent staircases, which have been designed for construction loads (possibly as free-standing structures).

To assist erectors in making structural connections at height, designers should consider the provision of seating cleats, pre-attached to columns.

Where structural steel sections are to be connected to other components (*e.g.*, concrete) the brackets for these connections should be installed in the process of construction of the other component (*e.g.*, cast into the concrete). This could be more of a problem in existing buildings.

To prevent falls through roofs, designers should only specify non-fragile assemblies, in which all the components are non-fragile. [This would also mean that removal of components for maintenance work would not render the remaining assembly non-fragile].

Where the steelwork is to support horizontal lifelines, designers should consult fall protection experts about the magnitude of the fall forces that may need to be resisted by the steel stanchions or the structural members.

#### **1.4.4 REDUCTION OF HAZARDS ASSOCIATED WITH CRANES**

To facilitate the lifting of structural steel members, designers should:

- a) Consider the space requirements for cranes;

- b) Consider the provision of lifting points and specify these as an item for the fabricator to design;
- c) Design structural members to resist loads from lifting points (e.g., sling component loads);
- d) Where necessary, ensure that the spacing of purlins allows for the largest component to be lowered between them with sufficient clearance;
- e) Show on shop drawings, the maximum length of the piece or weight to be lifted and its location (to allow the contractor to select the appropriate crane).

#### **1.4.5 MANHANDLING OF LOADS**

This problem occurs mainly, though not exclusively, on renovation projects, where, due to the situation of the work (e.g., inside an existing building where cranes cannot be used), workers are often required to manhandle steel members into position. To facilitate this, the weight of the individual structural steel members should be minimized by:

- a) Designing beams with splices, to allow piecemeal installation of the beam, and maneuvering in limited spaces;
- b) Replacement of one section with two, instead of a single section;

In addition, structural steel members should be detailed with site constraints in mind. For example, where members must be transported through corridors, their length should be compatible with maneuvering spaces, especially around corners.

Erection tolerances should be taken into consideration in detailing structural members for fabrication. This is more of a problem in existing buildings into which steel sections are being installed. In these circumstances, a detailed survey of the building should provide the necessary dimensional accuracy. Designers/Steel detailers also should be aware that erection tolerances for various materials (other than steel) are different.

In the connection of steel to other materials, it is likely that fin-type connections will pose less of a handling problem than end-plate type connections.

It should be possible vertically to lift members that are to be installed vertically.

#### **1.4.6 DESIGN TO REDUCE HAZARDS ASSOCIATED WITH TEMPORARY WORK PLATFORMS AND OTHER EQUIPMENT**

Temporary work platforms must be stabilized. Designers (Detailers) should consider the provision of attaching structural members to the temporary work platforms. For example:



July 2017

- a) Cladding side rails could be designed with scaffold ties, to carry the lateral loads that might be applied;
- b) Eave members should be designed to carry lateral loads imposed by the future attachment of mobile towers;
- c) Profiled steel forms and supporting steel beams should be designed to carry the concentrated leg loads that could be applied by a mobile tower;

The ability of structural members to support the fall-arrest forces by fall-arrest equipment should be verified. Structural members that are not designed for fall-arrest forces should be clearly labeled with warnings.

In order to assist a contractor to detail temporary supports, designers should provide sufficient information to ensure that a contractor has a clear understanding of the needed stability.

On multi-story buildings, much of the steelwork is erected with aerial lift equipment. Therefore, designers should consider the provision of space around the building perimeter, to accommodate such equipment.

In addition to design to make steel erection safer, designers should consider minimizing maintenance work in order to reduce the exposure of workers to health and safety hazards when performing maintenance work after the completion of construction.

**End of Section**

## **2. MANAGEMENT OF HAZARDS DURING MAINTENANCE PHASE**

Falls from height are a major cause of work-related injuries and fatalities. Engineers, architects, designers, detailers, and planners are responsible for designing safe buildings, facilities, structures and equipment. They should strive to eliminate, minimize or prevent the hazards of falling at work places. Post-construction, the facility should protect personnel during normal work operations and should help maintenance personnel to conduct their work safely and without exposure to fall hazards.

### **FALL PREVENTION PHILOSOPHY FOR DESIGNING NEW BUILDINGS AND FACILITIES:**

New buildings, facilities, or structures should be designed to the extent possible to eliminate the need to work at heights. When fall hazards cannot be eliminated or prevented, designers should provide alternative remedies such as installation of anchorage points.

Any location or part of a building, structure, facility or equipment will eventually require maintenance, remodeling, modification or replacement work. Engineers and architects should consider these factors in the design of new buildings.

### **2.1 FACILITATION OF FUTURE MAINTENANCE WORK**

Designers should take into consideration future maintenance of the proposed building or facility, because they are in a strong position to eliminate and/or minimize the requirement to work at height during maintenance operations. For example, designers could:

- a) Ensure that any equipment requiring maintenance work is not located at height (e.g., on roofs with unprotected sides or edges);
- b) Specify high durability materials;
- c) Locate system/process pipe-work at ground level where practical;
- d) Avoid locating high maintenance items above stairwells and other deep recesses;
- e) For cleaning/washing, specify reversible windows above the first or second floor. Where this is not appropriate, ensure that provisions for access equipment are incorporated at the design stage.

The designer should apply the principles of prevention to assure that, where reasonably practical, the hazard of working at height is eliminated, removed, minimized, or finally controlled.

### **2.2 HAZARDS OF MAINTENANCE WORK ON ROOFS**

The benefits of eliminating, or at least minimizing, the need for personnel to access and perform work on roofs is not restricted to protecting personnel from falls; although that is a

major one. Other benefits include the easing of frequent maintenance by locating equipment at grade level; the elimination of foot-traffic or equipment-induced damage to roofing materials; and reduction of the time required for access to equipment. It should be unnecessary to perform a cost-benefit analysis, in most cases, to illustrate the truth of these statements.

### **2.2.1 BACKGROUND INFORMATION ON ROOFS**

Even non-fragile assemblies can be made fragile if the wrong type of material is specified. Therefore, pay careful attention to the environment in which the building is being erected. Known harsh environments include:

- a) Coastal areas, which are highly corrosive;
- b) Industrially-polluted areas, which contain airborne agents of deterioration;
- c) Industrial processes which release harmful agents;
- d) Areas of intense solar exposure, snow or ice loading, and rain ponding. Each of these environments exists in locales of various DON installations.

With respect to maintenance, there are three basic types of roofs:

- a) **Low maintenance roofs**, which require very infrequent access or simple du-pitched roofs requiring maintenance that can be done only from ladders or aerial work platforms;
- b) **Medium maintenance roofs**, which require regular access for maintenance but only by experienced roof workers;
- c) **High-maintenance roofs**, which require frequent access for maintenance (e.g., roofs with penetrations for machinery exhausts stacks, etc.).

Manufacturers' recommendations for compatible components in non-fragile assemblies should not be changed without consultation with the manufacturers.

### **2.2.2 DESIGN TO MINIMIZE THE NEED FOR ACCESS AND WORK ON ROOFS**

This can be achieved either by minimizing the number of items requiring maintenance on a roof or minimizing the number of times people have to go on a roof, for example by:

- a) Routing vent stacks through the building side instead of the roof;
- b) Combining exhausts flues into a single vent enclosure;
- c) Assure that process by-products are effectively removed and discharged high enough above the roof to allow effective dissipation;

- d) Avoid specification of materials for which the manufacturer's warranty requires annual inspections;
- e) Optimize the number and position of roof-lights, taking into consideration the requirements for providing natural light;

Note: Roof-lights will require periodic cleaning to maintain correct light levels within a building.

- f) Position gutters so that cleaning can be carried out using either articulated boom lifts, or from other designated means of safe access.

The resealing of joints is a common reason for the presence of personnel on roofs. Therefore, specify durable seals and details at penetration points and flashings, to minimize the need for such repetitive maintenance.

Robust structural details for areas of the roof exposed to high wind suction should ensure that damage is minimized during predictable windstorms, to minimize the need for maintenance after such storms.

### **2.2.3 MINIMIZE THE RISK OF FALLING FROM UNGUARDED EDGES**

Where it is not possible to eliminate the need for roof access, items that need maintenance should be located at least:

- a) Six feet away from skylights, or the skylights should be protected;
- b) Locate the equipment far away from the edges of roofs to make it unnecessary for people to work close to the edge of the roof, and impossible to carry out the work from a ladder; and
- c) Skylights should not be within 6 feet of an edge.

In addition, provide dedicated walkways to access the items to be maintained, which should be:

- a) Non-fragile and slip-resistant for the life of the roof; and
- b) Provided with a hand-rail, if possible. Where this is not feasible, a horizontal lifeline to which a lanyard can be attached should be installed.

Workers also are vulnerable at gables and eaves. Where parapets are not desirable, design brackets to which temporary edge protection can be fixed. Discuss solutions with suppliers of temporary edge protection.

Where horizontal lifelines are provided, design the anchorages for the system to withstand the fall forces. If dead-weights (ballasted or free standing anchors) are the intended means of

anchorage, check that the roof can support the weight of the anchor taking into consideration the friction of the roofing material. Restraint systems are preferred to fall arrest systems.

#### **2.2.4 MINIMIZE THE RISKS OF FALLS FROM WORK AREAS**

Gutters will, inevitably, require regular cleaning; therefore,

- a) Where possible, cove the top of gutters to prevent leaves from accumulating, such that dirt will not clog the gutters. Only rain water should enter the gutters.
- b) At eaves gutters, consider provision of a solid base around the building perimeter. Only when this is impractical should ladders be used, with provision of ladder-tying points at 6 feet on centers close under the gutter, with a hard and level base for the ladder for the full length of the gutter.
- c) Design valleys strong enough and wide enough to allow walking safely.

#### **2.2.5 MINIMIZE THE RISK OF FALLING THROUGH ROOFS**

To prevent falls through roofs, specify non-fragile assembly/materials.

Where frequent traffic on roofs is necessary (e.g., high-maintenance roofs), the pitch should not exceed 4 in 12, and dedicated access points, and walkways with hand-rails, should be provided to the work area.

Prohibit foot traffic on skylights; otherwise the surface may be damaged to the extent that it impairs light transmission. Skylight layouts should allow cleaning from clearly defined traffic areas with travel across the roof in straight lines without the necessity of walking on skylights.

Highlight the hazardous and non-walk areas by clearly visible pathways.

When incorporating skylights in the roof design, investigate the effects of weather (e.g., Will intense solar exposure change the color of the roof and the skylights?). For this reason, always specify skylights to have a non-fragile design life greater than that of the opaque area of the roof, and select an opaque color to avoid a monochromatic roof surface (Avoid the whole roof looking the same).

Where fragile assemblies are unavoidable; for such translucent assemblies, design systems for their safe cleaning and maintenance.

### **2.3 ADDITIONAL DESIGN CONSIDERATIONS**

#### **Preventive considerations for selective listing of design issues and examples:**

- Where feasible, design roofs of buildings or facilities with minimum slope, rather than steep slopes; minimize the slope of the roof as much as possible. Of course, it may be desirable in regions with deep annual snow accumulations to have steep sloped roofs to shed the weight.
- Always incorporate edge protection (e.g., standard guardrails or 42-inch parapets) around all open sided floors or openings. Consider designing roof parapets, at least 39 inches high, to serve as permanent guardrails along the roof edge. Provision for snow load on the roof structure should be considered when designing parapets.



- Where the design includes installation of a fall arrest system or horizontal lifeline, always be alert to the existence of other equipment operating in the same area (e.g., interference between the use of a fall arrest system or horizontal lifeline with crane operations, such as inside hangars or other buildings).
- In the design of “flat” roofs, incorporate guardrails or parapets 42” ± 3” in height, around the perimeter.
- Locate equipment (e.g., HVAC) away from the edge of the roof, or provide standard guardrails around it. Roof vents, mechanical equipment, and communications equipment should be located at least 15 feet away from the roof edge. The 15-foot distance reduces the risk of a fall during equipment maintenance. Specify permanent guardrails when equipment must be located closer to the roof edge.



- Use luminaires that can be replaced or maintained without exposing the personnel to the hazard of fall. As an example: in a gymnasium, use luminaires that can be lowered to the ground for changing lamps; or provide catwalk or platform to access such fixtures.
- Where windows must be operable, consider inward operating sash above second floor, so that window washing can be performed from the inside of the facility.
- Locate water valves, meters and other equipment and instrumentation at locations where the employee can perform necessary service without being exposed to a fall hazard.
- Where the design of buildings and facilities does not allow the use of conventional methods of fall prevention (such as the use of guardrails or other methods) design or select anchor points to withstand a force of 5,000 pounds per person, at any location with the potential of a fall from height.
- Stairs are preferable to ladders for elevation changes of 20 feet or greater.
- Always provide safe access to service equipment, instrumentation and other amenities within the building or facility.
- Design guardrails or specify covers for utility holes, even if only a few feet deep. A fall into a shallow utility hole such as those for steam or electrical lines might expose a person to other hazards such as scalds or electrocution.
- Plan on providing fall-prevention/control methods including safe access of future maintenance for any equipment, fixture, or part of a building or facility.



July 2017



- Study maintenance procedures, work practices, and building and facility operations, to minimize the potential for falls by maintenance personnel.
- Provide safe access and egress to every location inside or outside of buildings or facilities.
- Understand the governing safety regulations and standards.
- In addition to design knowledge, the designer should be familiar with construction operations for a facility, and have the knowledge of the logistical operations during occupancy and any maintenance required afterwards.
- Minimize the width of parapets or short walls, or provide steeply sloped cap flashing. Some occupants of buildings have a tendency to sit on wide parapets; thereby exposing themselves to fall hazard.
- In the selection of fixtures, equipment, or other items to be installed on roofs, such as projectors, flagpoles, or surveillance cameras, always keep in mind maintenance requirements of such equipment or fixtures. As an example, install cameras or luminaires on tracks that can be pulled away from the edge of the roof for maintenance or service.
- Understand and identify the delivery of material or equipment procedures during construction operations. This will help in siting the building and access roads for vehicles or equipment to deliver such material safely.
- Try to eliminate any blind spots in the design.
- All hatches and openings shall be protected either by a cover or guardrail and the access ladder shall extend above the hatch. Specify the roof hatch safety system as soon as possible. The new hatches can provide for a standing access either out onto the roof or into the opening which fits the human condition and walking posture in work situations such as access to and from roofs. Existing hatches can be retrofitted in the same way. Provide guardrails around the hatch with a swing gate, or provide horizontal grab bars.



- Provide adequate lighting for maintenance work within a building at locations near or within close proximity of a fall hazard.
- Provide fall protection where an exposure exists for falling into water (e.g., working from a pier).
- In the design of elevated pier lighting standards, place any needed utility covers on the inside (safer location, so that the person performing maintenance service on the pole will not be exposed to a fall hazard).
- For skylights, either incorporate guardrails around the perimeter, or build the skylight at least 42 inches above the roof level.



- If needed, specify permanent roof anchors to provide convenient tie-off points for work near the edge of the roof.



- Specify roof materials that do not require frequent inspections.
- Locate gutters such that they can be cleaned using articulating lifts, or in other safe access areas.
- Specify durable seals at roof penetrations to minimize the need for maintenance.
- For fixed roof-access ladders attached to the side of building, specify a ladder-climbing system instead of a cage. Cages are allowed by OSHA, but protect no one from falling.

July 2017

Even if a ladder-climbing device is used inside a cage, rescue of a person inside a cage will be very difficult.

- In hangars, where horizontal lifelines (HLLs) are used as the fall protection solution for aircraft maintenance, make sure that there will be no interference between the crane envelope inside the hangar and the HLL system. The cranes usually are 30 to 40 feet above the working level. Additionally, incorporate a Power Tagline System to bring the snaphook of the self-retracting lanyard (which is attached to the HLL) to the working level.



Power Tagline System

- For safer maintenance work, service runs could be designed for access from the floor above.

**End of Section**

July 2017

## **APPENDIX F**

### **FALL PROTECTION TRAINING COURSE SYLLABUS**

### **FOR COMPETENT PERSONS**

#### ***Day 1***

##### **Course Introduction**

- **Course Objective**
- **Safety Briefings**
- **Instructors, Students introduction**
- **Fall Mishap Statistics for DON, Industry and construction**
- **Applicable trigger heights (When Fall Protection is required?)**
- **Examples of fall related hazards**
- **Various types of falls (From roofs/ladders/etc.)**

##### **Regulations, Standards and Instructions**

- **Applicability**
- **OPNAVINST 5100.23 Series, FP program requirements**
- **DON Fall Protection Guide**
- **NAVMC DIR 5100.8 Chapter 18, FP Program**
- **USACE EM 385-1-1, Section 21, Fall Protection**
- **29 CFR 1910, 1926, 1915, 1918 and 1960 Standards**
- **29 CFR 1910 Final Rule dated 17 November 2016**
- **American National Standards Institute, ANSI Z359 Fall Protection Code/Standards**
- **FAR Clause 52.236-13**
- **Similarities and Differences between various standards**

##### **Roles and Responsibilities**

- **Program Manager, Qualified person, Competent person and End Users (Authorized Persons)**
  - **Definitions in General Industry vs. Construction standards and ANSI Z359 FP Code**
  - **Comparison of duties/responsibilities and required skills/qualifications**

### ***Hierarchy of Fall Hazard Controls***

- **Preferred Order of control measures (DON)**
  - **Elimination**
  - **Prevention**
  - **Engineering controls (Design change or using different techniques or equipment such as movable or stationary work platforms)**
  - **Administrative controls including examples**
  - **Personal protective systems and equipment**
- **Comparison among DON, EM 385 and ANSI hierarchy of fall hazard controls**

### ***Fall Hazard Survey and Assessment***

- **How to conduct the survey to identify potential fall hazards**
- **Identify environmental factors**
- **Fall hazard assessment**
- **How to develop fall hazard survey report**

**(The instructor is required to provide examples of best practices of fall hazard identification and the students shall conduct a mock survey of a fall hazard.)**

### ***Elimination of Fall Hazards***

- **Best practices of Hazard elimination**
- **Examples and exercise of hazard elimination**

**(The instructor is required to provide examples of best practices and considerations for eliminating fall hazards. The students shall be required to perform an exercise on how to eliminate the fall hazard.)**

### ***Prevention systems (Traditional/Conventional Fall Protection Systems (Passive Systems))***

- **Definitions and requirements for:**
  - **Guardrails(requirements, strength, minimum material of construction and examples)**
  - **Covers and Barricades**
  - **Safety nets**



July 2017

- **Stair rails and handrails**
- **Applicable regulations, Standards and instructions**
- **Examples of prevention/conventional systems**
- **Prevention System Exercise**

**(The instructor shall show a variety of slides/photos of prevention systems. The students will be asked to identify requirements and/or deficiencies.)**

### **Fall Arrest System**

- **Definitions**
- **Components of the system**
  - **Anchorage system**
  - **Connecting means**
  - **Body support**
- **Applicable regulations/standards/requirements**
- **Verification and certification testing requirements of the equipment**

### **Anchorage System (Anchorages and Anchorage Connectors)**

- **Definitions/Applications**
- **Maximum arresting force/impact forces/requirements for: FA positioning and restraint**
- **Engineered vs. improvised anchorages**
- **Applicable regulations/Standards**
- **Certified vs. non certified anchorages**
- **How to identify safe anchorages and tie-off points for various systems (Non Certified anchorages)**
- **Examples of unsafe anchorages**
- **Compatibility between anchorages and anchorage connectors**
- **Swing fall hazards**
- **Demonstration of various anchorage connectors and tie off techniques**

### ***Continue Anchorage System***

- **Workshop**



**(The instructor is required to demonstrate variety of anchorage connectors, including photos/slides on how to identify safe anchorages and the method for attaching anchorage connectors to the anchorages.)**

***Day 2***

***Connecting Means (Snaphooks, Carabiners and other connectors)***

- **Definition/application**
- **Snaphooks and Carabiners (Types, applicability, Compatibility and misuse)**
- **Hazards associated with various connectors (roll-out/forced roll-out,**
- **Regulations and standards/requirements**
- **Proper use of and examples**
- **Navy prohibited use of snaphooks and carabiners meeting ANSI Z359.1 (1992, R1999)**
- **Exercise and Demonstration of equipment**

**(The instructor shall show variety of snaphooks, carabiners and other connectors including use and misuse examples and the students will be asked to identify requirements.)**

***Connecting Means (Lanyards and Energy Absorbers)***

- **Definitions/Applications**
- **Various types of lanyards (FA, Positioning, Restraint)**
- **Proper use and examples of lanyards and energy absorbers**
- **Requirements for 6 ft. and 12 ft. free fall energy absorbers (single leg or Y-lanyard)**
- **Maximum deployment/deceleration distances**
- **Hazards associated w/energy absorbers (Weather, type, increased fall distances, location/rigging and safe practices**
- **Applicability of the standards**
- **Correct installation techniques**
- **Hazards and warnings associated with the use of Y- lanyards**
- **Exercise and demonstration on the use of various equipment**

**(The instructor will demonstrate various energy absorbing lanyards and the students will be asked to identify requirements and proper usage.)**

***Connecting Means (Fall Arresters)***

July 2017

- **Definitions/Applications**
- **Proper use and examples of site specific energy absorbers**
- **Hazards associated w/fall arresters (Type, fall distances, location/rigging and safe practices**
- **Applicability of the standards**
- **Exercise and demonstration of equipment**

**(The instructor shall demonstrate various fall arresters and the students will be asked to identify requirements and proper usage.)**

### ***Self-Retracting Devices (SRDs)***

- **Definition/Application**
- **Proper use including examples of various SRDs**
- **Various SRDs used in horizontal and vertical applications**
- **Maximum arrest distances**
- **Inspection requirements of SRDs Hazards associated with SRDs Factory authorized Inspections**
- **Applicable regulations/Standards/Requirements**
- **SRD exercise and demonstration of various types and classes of SRDs**

**(The instructor will demonstrate various SRDs and the students will be asked to identify requirements and how to inspect the equipment.)**

### ***Body Holding Devices***

- **Definition/Application**
- **Types of body holding devices (full body harness, body belts, sit harness, etc.)**
- **Hazards associated /body holding devices suspension hazards and misuse**
- **Donning and doffing of the equipment**
- **Prohibited uses of body belts and sit harnesses**
- **Proper use and examples of site specific body holding devices**
- **Applicable regulations/Standards/requirements**
- **D-ring locations on the full body harness including uses**
- **Capacity range of the equipment including overweight and underweight users**

July 2017

### ***Hands-On and Practical Demonstrations***

- **Workshop (Attendees use various FP equipment)**
- **Exercise and Demonstration of the equipment**

**(The instructor will demonstrate various types of harnesses on how to connect a complete personal fall arrest system to anchorages using various scenarios. Each student shall demonstrate how to don the harness safely. The students shall also be suspended from a tripod wearing the harness. While suspended, the students should also use suspension straps to increase suspension time.)**

### **Drop Test Demonstration**

- **How the body reacts to fall arrest forces**
- **Articulating manikin demonstration**
- **Variety of drop tests**

**(The instructor will show a video of various drop tests of manikins wearing a harness and various lanyards.)**

## ***Day 3***

### ***Single Anchor Vertical Lifelines***

- **Definitions/Application**
- **Proper use of the equipment and examples of various applications**
- **Maximum arrest distances**
- **Hazards associated with misuse of the system/equipment**
- **Applicable regulations and standards**
- **Single anchor vertical lifeline exercise**

**(The instructor will show video/slides/photos of vertical lifeline and associated equipment used in the process.)**

## **Review and exam #1**

### ***Horizontal Lifelines***

- **Definition/Application**

July 2017

- **Impact of fall forces**
- **Proper use of the system**
- **Critical elements of the system**
- **Factors affecting design of the system (# of workers, span length, intermediate anchors, material of components, sag and tensioning of the line, clearance)**
- **Need to be engineered system, designed and used under the supervision of a qualified person**
- **Roles of CP and QP/Professional Engineer during use, assembly and inspection of the system and selection, design, use and certification of HLL anchorages**
- **Applicable regulations and standards**
- **HLL exercise**

(The instructor shall show video/slides/photos on how to install, use and inspect HLLs. The instructor shall also demonstrate some of the components of the system.)

### ***Raising & Lowering Devices***

- **Definition/Application**
- **Various types of raising/lowering devices including descent control systems, pulleys and winch systems**
- **Proper use and operation of the systems**
- **Hazards associated with the systems**
- **Raising/lowering devices exercise**

(The exercise addresses various devices including video and slides)

### ***Positioning System***

- **Definition/application**
- **Various types of devices**
- **Application, uses and proper operation of the devices**
- **Hazards associated with and misuse of the system (hooking, unhooking and fall distances)**
- **Applicable regulations/standards/requirements**
- **Work positioning exercise and demonstration**

(The students will be required to use equipment to be tied off to a vertical surface at heights attached to fixed ladder.)

### ***Restraint system***

- Definition
- Examples of various uses of the system
- Proper use of the equipment
- Hazards associated with the use of the system
- Applicable regulations and standards
- Exercise and practical demonstration

(The instructor will demonstrate how to use the system and the students will be required to assemble safe system using the equipment.)

### ***Inspection Care & Maintenance of Fall Protection Equipment***

- Type of inspection
- Daily and inspection (prior to each use)
- Equipment Markings and Labels
- Annual/Semi-annual (by a competent person with documentation)
- Re-certification (by the manufacturer/qualified person)
- Equipment removal from service
- Applicable regulations/standards
- Exercise and Demonstration of equipment inspection with examples

(The instructor will demonstrate how to inspect the equipment in detail and document the inspection. The students shall also identify defects in the equipment.)

## ***Day 4***

### ***Climbing Ladder Fall Arrest System***

- Definition/application/requirements
- Types of ladder climbing devices
  - Rigid rail
  - Rope
  - Cable
- Proper attachment of the system and best practices
- Operation and uses

July 2017

- Hazards associated w/ladder climbing devices
- Applicable regulations/Standards and requirements
- climbing ladder FA system exercise/demonstration

(The instructor will demonstrate various climbing ladder FA devices. See also positioning system for additional exercise.)

### ***Rescue/Assisted Rescue***

- Definition/applicability
- Basic rescue methods and procedures (manual descent, automatic decent control)
- Rescue planning (Rescue plan Development)
- Rescue equipment
- Applicable regulations/standards/requirements
- Rescue scenario exercise/demonstration

(The instructor will oversee the students demonstrate of an actual rescue exercise of a fallen and arrested worker.)

### ***Aerial Lift Equipment, Work Platforms, Staging/scaffolds***

- Definitions/application/requirements
- Applicable regulations and standards
- Hazards associated with the use and or misuse of Supported, Self-Supported and Suspended Scaffolds
- FP requirements for AWP/Scaffolds

### **Warning Line System/Designated Area/Controlled Access Zone/Monitoring System and Fall Protection Plan**

- Definition/requirements and Applications
- Prohibited and permitted uses
- Hazards associated with using the above systems, prohibition and permitted uses
- Applicable regulations and standards

### ***Fall Protection Problem Solving***

- Workshop, students are presented with as many working at height scenarios as possible

July 2017

- **Students must demonstrate applied learning by solving fall hazard scenarios presented by applying hierarchy of fall protection**
- **Students perform Navy fall hazard analysis (per OPNAVINST 5100.23 series), erect, use and dismantle fall protection systems under the supervision of the instructor**
- **How to calculate free fall distance, total fall distance and clearance requirements including maximum deployment/deceleration and arrest distances**

### ***Day 5***

#### ***Engineered System***

- **Specifications for engineered systems**
- **Testing of anchorage system**
- **Off the shelf vs. custom solutions**
- **Documentation and certification**
- **Recommendations for engineered system requirements**

#### ***Preparation of Fall Protection & Prevention Plans (Written Fall Protection Procedures per ANSI Z359.2)***

- **Components of the plan**
- **How to write fall protection & Prevention plans (Work Procedures)**
- **Written SOP Exercise**

**(The students shall develop a fall protection and prevention plan of an actual fall hazard location.)**

#### ***Preparation of Fall Hazard Rescue plan***

- **Components of the plan**
- **How to develop the plan**
- **Written SOP Exercise**

**(The students shall develop a rescue plan of an actual fall hazard location.)**

#### ***Requirements, Best Practices and Fall Hazard Issues associated with:***



July 2017

- **Portable ladders**
- **Fixed ladders**
- **Working over water**

***Final Exam and course Conclusion***

- **Written Examination**
- **Review and marking of the exam**
- **Course evaluation**
- **Questions and answers**
- **Conclusion**

**Note:**

**At the completion of the training the attendees shall be able to demonstrate their working knowledge of fall arrest equipment, procedures and requirements through hands-on and practical demonstrations.**

**End of Section**

## **APPENDIX G**

### **HUMAN SYSTEM INTERFACE WITH PERSONAL FALL ARREST SYSTEM (Medical Aspects)**

Unlike most PPE, the Personal Fall Arrest System is a complex system that on the surface has a very simplistic interface with the human body but many aspects of this interface must be considered to ensure optimal protection of user.

First and foremost is the user's size or weight. When working at a given height there is the application of simple physics in that the greater the weight of the worker the greater the potential energy. In the event of a fall the greater the potential energy will convert to greater kinetic energy that must be arrested by the PFAS.

#### **Weight**

Per the ANSI Z359.11 Harness standard user weight (capacity) is identified as 130 lbs. to 310 lbs. If users at the extremes of this range are exposed to an 1800 lbs. Maximum Arrest Force they will absorb different forces on their respective bodies. The 130 lb. users may experience up to 13.8 Gs (1800 lbs. /130 lbs.) on their body vice the 310 lbs. user who may see as much as 5.8 Gs (1800 lbs. /310lbs.). These forces are of extremely short duration and generally considered acceptable due to short duration.

The greater weight of an individual the more potential energy will be encountered during a fall. The greater the potential energy, the greater the kinetic energy in the event of a fall and therefore the higher the forces which may be encountered.

With a lighter weight worker a different phenomenon is experienced. As equipment is designed to arrest a fall with dissipation of energy and that is based on the higher weight workers. As there is an excess of energy dissipation available, less energy dissipated therefore transferring that energy into the body of lighter weight individuals, subjecting them to higher arresting forces.

The ANSI Z359.1 fall protection standard has suggested a limit of 10Gs for gravitational force tolerance for human body based on the Eiband Curves and testing by Col J.P. Stapp in the late 1950s. It is important to note that no testing occurs to determine predictable G forces imparted by any component of PFAS.

#### **Height**

The height too is an important consideration in the user interface with PFAS. There are no minimum or maximum height requirements prescribed by ANSI standard or regulation. That

said, considering demographics of population, it is reasonable to expect a difference in overall height, and therefore height of dorsal d ring, between shorter and taller workers. In some cases this may be in excess of 2 feet. That in itself is not an issue but does begin to potentially infringe on safety factor within clearance calculations.

## **Gender and Shape**

Within the diverse workforce it is expected to see users of same height and weight that have varying body shape. The performance of the PFAS is directly related to appropriate fit and adjustment. It is feasible that two workers of equally height and weight will not be able to get same fit with identical harnesses even with adjustment. This is an important consideration for supervisors. Human tolerance and threshold is individual attribute and will differ among workers of same gender let alone opposite gender.

## **Fitness**

Depending upon the type of work environment and environmental conditions fitness too will play a factor in workers ability to use PFAS.

## **Mental State**

Fitness for work at height should be a consideration as various phobias, fears and other illnesses and conditions may predispose workers at height too problems. Balance issues may cause the onset of a fall. Are workers afraid of heights? DO they get vertigo? These are factors that should be known prior to sending worker aloft vice after a fall or an incident at height. If you are knowingly putting workers at height in PFAS then more people are potentially exposed considering those that must respond.

## **Fall Injuries**

The use of PFAS may reduce poetical injuries but cannot eliminate the potential juries. For this reason it is worth taking a closer look at potential injuries. The most basic injury will be from impact to ground or lower surface from the fall. Those impact forces imparted on the body may present in a variety of ways three categories of injury breaks, soft tissue neurological.

### **Breaks**

Breaks are largely considered caused by impact or secondary impacts. The geometry of the fall will dictate tremendously the injury from impact or collision this should be less than fall but may involve swing on multiple variables. Breaks and fractures due to secondary impact may require rapid rescue and medical intervention post fall. Breaks are not expected from arrest as the duration of force is so low.

### **Soft Tissue**

Soft tissue injuries may present in a variety of ways. The most common will be in areas of poorly adjusted harness which may incur abrasion and bruising. Higher forces or asymmetric forces may cause internal injuries. The human tolerance to soft tissue injury in fall arrest needs to be further explored.

### **Neurological injury**

Arrest forces are largely focused in the vertical axis of the body along the spine. The application of arrest force is in pelvis but that force will translate to spine. The possibility of hyper-flexion of neck and concussive forces may lead to concussion or fracture of vertebrae in the event of fall arrest. Although human tolerance of spine in vertical arrest is understood from Eiband research it only considers forces in vertical axis of body. The Seddon Study by the Health Safety Executive of the UK is an excellent source of further information on this subject

After the fall has been arrested it is critical that the victim be rescued rapidly. The longer the victim remains in the suspended position there is a possibility of what is known as suspension trauma or orthostatic intolerance. In this scenario blood pools in the legs, blood pressure decreases and the brain in turn gets decreased oxygen. The body's way of compensating for this is syncope or fainting. Fainting brings the body, in theory, to the ground and the heart is now at same level as body thus allowing blood to resume normal path. Unfortunately the body response in a suspended harness does not result in return of oxygen and further and changes self-rescue or assisted rescue into a rescue.

Many harness manufactures have equipped harnesses with suspension straps that allow worker to step into strap to take pressure off of leg straps and allowing increase in blood flow, thus preventing fainting.

### **Post Rescue**

Once the fall victim is on the ground they must continue to be evaluated by medical professionals. If blood has pooled for a period of time it may become toxic and shock other parts of the body during flow of toxic blood. This is known as reflow syndrome. Dr. Roger Mortimer did research into this phenomenon. There are unfortunately differing schools of thought on treatment as to if harness should be removed or not or if victim should remain in seated vice prone position.

### **Engage Medical Staff**

The risks of PFAS must be articulated to medical personnel such that they can provide the required insight and recommendations to ensure the required protection of workers using Personnel Fall Arrest Systems.

**End of Section**

## APPENDIX H

**Subj: FIXED METAL LADDERS**

### Fixed Metal Ladders Inspection Checklist

---

**General Information:**

**Activity:** \_\_\_\_\_

**Date of Inspection:** \_\_\_\_\_

**Ladder Location:** \_\_\_\_\_

**Building:** \_\_\_\_\_

**Inspection Conducted by:** \_\_\_\_\_

**Department/Code:** \_\_\_\_\_

---

**Purpose:** This inspection checklist is to help ensure existing fixed metal ladders used for safe access are in **compliance** with OSHA Final Rule 29 CFR 1910.23(b) and (d) requirements. Where applicable, the list has the specific portions of OSHA and/or ANSI referenced where the ladder safety item originates.

**Guidelines:** This checklist covers regulations issued by OSHA under the Final Rule, general industry standard 29 CFR 1910.2(b) and (d) and ANSI A14.3 Standard – Safety Requirements for fixed ladders. For the required material used in manufacturing metal ladders, see UFGS 05 51 33.

This checklist also addresses fixed ladders with cages, landing platforms, and ladders exceeding 20 feet in height and ladder safety systems.

**Disclaimer: This checklist does not apply to the following;**

- 1. Fixed ladder rungs and steps on telecommunication towers and elevator shafts.**
- 2. Individual rung ladders**
- 3. Mobile ladders**
- 4. Step bolts and manhole steps**

**Legend:**

**Y:** Yes, **N:** No      **N/A:** Not Applicable      **FR:** Final Rule

---

Please Circle

1. Are the ladder rungs spaced not less than <b>10 inches</b> and not more than <b>14 inches</b> Apart, as measured between the center line of the rungs and uniform throughout the length of the ladder? [FR,1910.23(b)(2)]	Y	N	N/A
2. Is the minimum clear <b>length (width) of rungs or cleats 16 inches?</b> [FR, 1910.23(b)(4)]	Y	N	N/A
3. Is the minimum perpendicular distances from the centerline of the steps or rungs, or grab bars, or both to the nearest permanent object in back of the ladder is 7 inches? [FR, 1910(d)(2)]	Y	N	N/A
4. Are the grab bars protruding on the climbing side beyond the rungs of the ladder that they serve? [FR, 1910(d)(3)]	Y	N	N/A
5. Do the side rails of the ladder extend 42 inches above the top access level or landing platform served by the ladder? [FR,1910(d)(4)]	Y	N	N/A
6. For through ladders, are the rungs omitted from the extensions, and the side rails flared to provide not less than 24 inches and not more than 30 inches of clearance? [FR,1910(d)(50)]	Y	N	N/A
7. If the ladder safety system is installed, is the clearance between side rails of the extension less than 36 inches? [FR, 1910(d)(5)]	Y	N	N/A
8. Do the grab bars extend 42 inches above the access level or landing platform served by the ladder? [FR1910(d)(70)]	Y	N	N/A
9. Is the size (cross-section) of grab bars the same size as the rungs of the ladder? [FR,1910(d)(8)]	Y	N	N/A
10. Is the <b>top rung</b> of the ladder level with the top of access/egress level or landing platform served by the ladder? [Required per ANSI A14.3 (2008) Standard, Section 5.3.1]	Y	N	N/A
11. Is the <b>first rung</b> within <b>14 inches</b> of the ground? [Required per ANSI A14.3 Section 5.1.1 (2008) Standard]	Y	N	N/A
12. Is the <b>top rung</b> of the ladder level with the top of access/egress level or landing platform served by the ladder? [Required per ANSI A14.3 (2008) Standard, Section 5.3.1]	Y	N	N/A
13. When a fixed ladder terminates at a hatch does the cover opens with sufficient clearance to provide easy access to or from the ladder [FR, 1910(d)(9)(i)]	Y	N	N/A
14. For through ladders, is the step-across distance from the centerline of the rungs between 7-12 inches to the nearest edge of the structure, building, or equipment? [FR, 1910(d)(12)(i)]	Y	N	N/A
15. For ladders without a cage or well, is the clear width on each side of the ladder centerline to the nearest permanent object at least 15 inches? [FR,1910(d)(13)(i)]	Y	N	N/A
16. For ladders without a cage or well, is the minimum perpendicular distance from the centerline of the rungs to the nearest object on the climbing side 30 inches or more? [FR, 1910(d)(13)(ii)]	Y	N	N/A
When unavoidable obstructions are encountered, the minimum			

clearance at the obstruction may be reduced to 24 inches, provided deflector plates are installed.			
17. Does the ladder meet the applicable OSHA and ANSI standards?	Y	N	N/A
18. Is the ladder in good working condition (no defects such as cracks, corrosion, or other deterioration that may impact safety)?	Y	N	N/A

### Inspecting Existing Fixed Ladders with Cages

(Required for ladders over **20 feet** in length to a maximum unbroken length of **30 feet.**)

**Note; The inspection is required to be performed on the cage until such time the cage is removed and the ladder is equipped with a ladder safety system or fall arrest system, see FR, 1910.28(b)(9)**

Cages Requirements are prescribed in 29 CFR 1910.27(1970) and ANSI A14.3 (2008) standards. The Final Rule did not include such requirements.

<b>Ladder Cages</b>			
1. Do side rails that might be used as a climbing aid provide adequate gripping surface without sharp edges? [29 CFR 1910.27(b)(2)]	Y	N	N/A
2. Does the bottom of the ladder <b>cage start 7-8 feet</b> above the base of the ladder? [29 CFR 1910.27(d)(1)(iv)]	Y	N	N/A
3. Is the bottom of the cage flared at least <b>4 inches</b> ? [29 CFR 1910.27(d)(1)(iv)]	Y	N	N/A
4. Is the clearance from the centerline of the ladder rung to the back of the cage between 27 and 28 inches and the cage is at least 27 inches wide? [29 CFR 1910.27 (d)(1)(v)]	Y	N	N/A
5. Are the vertical bars of the cage located at a maximum spacing of <b>40 degrees</b> around the circumference of the cage giving a maximum spacing of approximately <b>9.5 inches center to center</b> ? [29 CFR 1910.27(d)(1)(v)]	Y	N	N/A
<b>Landing Platforms</b> (required for ladders over 30 ft. in length, or 20 feet in length for ladders with no cages)			
1. Is the landing platform at least <b>24 inches by 30 inches</b> ? [29 CFR 1910.27(d)(2)(ii)]	Y	N	N/A
2. Is the landing platform equipped with standard railings and toeboards? [29 CFR 1910.27(d)(2)(ii)]	Y	N	N/A
3. Is one rung of a ladder section located at the level of the landing laterally served by the ladder? [29 CFR 1910.27(d)(2)(iii)]	Y	N	N/A



<b>Ladder Safety System</b> (Required for ladders over 20 ft. in length, in lieu of cages)			
1. Design requirement of the fall arrest system, not the ladder. Design requirement, would not be known to an inspector. Is a ladder fall arrest safety system installed on ladders greater than 20 feet in length were no cage is provided? OSHA 1910.27(d)(5)	<b>Y</b>	<b>N</b>	<b>N/A</b>

**If the ladder does not meet current standards or has deterioration:**

**Corrective Action(s):**

**Interim Corrective Action(s):**

**Note:**

**No one may grant exemptions from OSHA requirements, all OSHA violations must be corrected prior to allowing use of ladder.**

**Permanent Corrective Action(s):**

Additional Comments:

Include sketches/drawings of ladders with dimensions similar or copied from ANSI A14.3

**End of Section**

# **APPENDIX I**

## **FALL HAZARD SURVEY REPORT TEMPLATE FOR SQUADRONS**

July 2017

# EXAMPLE FALL HAZARD SURVEY AND ASSESMENT REPORT FOR SQUADRONS



## Fall Hazard Analysis Report (HAR) Squadron HSM-40 – Hangar 1552

For

Naval Station Mayport  
Mayport, Florida

Prepared for



Navy Mishap Prevention & Hazard Abatement Program

Prepared by

CJSeto Support Services, LLC  
San Diego, CA

July 2016

Distributed to U.S. Government and authorized agents only. All other requests for this document shall be referred to Debi Salmon – CJSeto Support Services, LLC.

## EXECUTIVE SUMMARY

CJSeto Support Services, LLC, (CJS) was contracted by Naval Facilities Engineering Command Southwest (NAVFAC SW) to identify fall hazards associated with Navy personnel from Squadron HSM 40 performing maintenance duties on MH-60 (SEAHAWK) aircraft in and around Hangar 1552 at the Naval Base Mayport, in Mayport, Florida. The hazards of interest are situations in which personnel would be in danger of sustaining injuries by falling from heights greater than 4 ft. without proper fall protection. CJS also performed a fall hazard survey related to MH-60 maintenance, as defined in Office of the Chief Naval Operations Instruction 5100.23G, Chapter 13, and referenced in the *Department of the Navy Fall-Protection Guide*.

CJS personnel visited the site in May 2016 and identified fall hazard situations present during MH-60 maintenance that is being performed in Hangar 1552, as well as at the aircraft wash-down apron, and on the flight line. As a result of the discussions and the trade-off analysis performed by CJS personnel, recommended solutions were identified for each hazard and a preliminary cost evaluation developed for each solution.

The cost estimate provided below (and detailed in the body of this report) includes the total equipment cost of implementing each of the recommended changes. The estimate provides a rough order of magnitude and will be refined when all factors of the selected option are determined.

CJS recommends the following fall protection solutions:

1. Four mobile, horizontal rail systems with two parallel rails each for use at the wash-down apron. These rail systems could also be used on the flight line when any maintenance outside of pre-flight checks is required.
2. Minor modifications to the existing blue stand currently being used. Safety chains should be installed across the top of the aircraft connecting the two sides of the stands to prevent a fall down the front. The stands need to be modified to better fit the contour of the aircraft, or safety chains should be installed to prevent workers from stepping in the large gaps between the aircraft and the stands aft of the main rotor. Swing gates should also be installed at the ladder openings. Three additional sets of maintenance stands should be procured for the use in the hangar bays for phase maintenance and longer-term maintenance evolutions to replace the other blue stands that are no longer serviceable.
3. Fourteen overhead rail anchor points (trolleys for I-beams) and 14 Class B self-retracting devices (SRDs; Nylon or coated cable) for use in the hangar bay on aircraft not supported by wrap-around stands. If wrap-around stands are not feasible, additional SRDs could be procured to support the other aircraft in the hangar.

July 2017

4. Three additional Little Giant® safety cage ladders. HSM-40 currently has five available. Three additional ladders would provide more versatility for flight line use as well as in the hangar.
  
5. Six anchor straps and lanyards for use in restraint during maintenance around the main rotor on the flight line or in the hangar.

If all the recommended equipment is procured, the total cost would be \$378,380. Potential alternative means of procurement for a few pieces of equipment were identified by both the assessment team and HSM-40 personnel. Two mobile, horizontal rail systems that are in near-new condition and an MH-60 wrap-around stand needing new hardware and minor repairs have been identified as possibly being available for repurposing from Naval Air Station Jacksonville. The potential financial savings if this equipment is available for repurposing to Naval Base Mayport would be \$69,400.

It was observed during the assessment that there were stands and rail systems present at Hangar 1552 that were in disrepair due to the lack of an ongoing maintenance plan. It will be critical to develop and establish a life-cycle maintenance plan to avoid degradation of the new equipment and to ensure the longevity of all the equipment procured as part of the recommendations above. For all equipment procured, a life-cycle plan will need to be established and maintained by developing local maintenance requirement cards that include corrosion prevention and treatment as well as yearly recertification for the stands and rail systems.

**TABLE OF CONTENTS**

EXECUTIVE SUMMARY ----- 339

1. INTRODUCTION ----- 345

    1.1 Background ----- 345

    1.2 Purpose ----- 346

    1.3 Approach ----- 347

2. HAZARD IDENTIFICATION AND EVALUATION METHODOLOGY----- 348

    2.1 Validation of Fall Hazards ----- 348

    2.2 Risk Assessment ----- 348

    2.3 Relative Risk Ranking ----- 350

    2.4 Mitigation Strategies ----- 350

3. PROGRAMMATIC EVALUATION ----- 351

    3.1.1 Requirements Flowdown ----- 351

    3.1.2 HSM-40 Programmatic Observations ----- 352

4. HAZARDS AND RECOMMENDATIONS DISCUSSION ----- 354

    4.1 Hazard Description ----- 354

    4.2 Hazard Analysis ----- 358

    4.3 Mitigation Strategies Evaluated ----- 359

    4.4 Cost/Benefit Trade-Off Analysis ----- 363

5. CONCLUSION ----- 366

    5.1 Recommended Mitigation Strategy ----- 366

    5.2 Cost Summary of Final Recommendation ----- 368

    5.3 Potential Cost Savings ----- 368

    5.4 Performance Requirements ----- 369

5.4.1	Performance Requirements for Mobile, Horizontal Rails -----	369
5.4.2	Performance Requirements for Maintenance Stands -----	369
5.4.3	Performance Requirements for Overhead Rail Anchor Points, SRDs, Anchor Straps, and Lanyards -----	370
6.	REFERENCES -----	372

APPENDIX A. Hazard Identification Data Sheets

APPENDIX B. Draft Procurement Specification

APPENDIX C. Cut Sheets and Quotations for Recommended Solutions

## FIGURES

Figure 1.	An aerial view of Naval Station Mayport, Florida (photo: U.S. Defense Imagery). The aircraft runway and large rectangular flight line area are visible to the right of the main loch. Hangar 1552 is located left of the flight line.--	346
Figure 2.	The northeast and southwest bays of Hangar 1552, the wash-down apron, and flight line at Naval Station Mayport. -----	354
Figure 3.	Corrosion issues noted on Blue Webb-Rite work stands. -----	355
Figure 4.	B-4 stand with swing gate taped open and no end rails used for access to the tail rotor. Work on top of the aircraft with no fall protection aft of the main rotor can also be seen. -----	356
Figure 5.	Corrosion issues noted on Webb-Rite Overhead Rigid Rail Systems located at the wash rack.-----	357
Figure 6.	B-4 stand observed at the wash rack to access and wash the top of the aircraft (left) and telescoping brush poles (right). -----	357
Figure 7.	Illustration and features of maintenance stands with guard rails for fall protection during work on aircraft within Hangar 1552.-----	359
Figure 8.	Little Giant® safety cage ladder next to the tail of an MH-60.---	360
Figure 9.	Overhead rail with mobile anchor point (left). An SRD (right) attaches to the anchor point. -----	361



Figure 10. Examples of tie-back lanyard (left) and anchor strap (right).--	361
Figure 11. Examples of mobile, horizontal rail systems. -----	362
Figure 12. Wash rack facility.-----	362

## TABLES

Table 1. Probability categories. -----	349
Table 2. Severity categories.-----	349
Table 3. Risk assessment matrix.-----	349
Table 4. Mitigation strategies for fall hazards.-----	351
Table 5. Areas of concern for fall hazards related to maintenance of MH-60 aircraft. -----	359
Table 6. Analysis of fall protection alternatives for maintenance atop aircraft in Hangar 1552 at Naval Station Mayport.-----	364
Table 7. Scoring matrix aiding in selection of solution.-----	365
Table 8. Summary of recommended solutions.-----	368
Table 9. Potential cost savings from repurposing equipment at NAS Jacksonville.	369

## ACRONYMS

ANSI	American National Standards Institute
ASM	Advanced Skills Management
CFR	Code of Federal Regulations
CJS	CJSeto Support Services, LLC
CP	competent person
HAR	hazard analysis report
HSM	helicopter maritime strike squadron
NAVFAC SW	Naval Facilities Engineering Command Southwest
OPNAVINST	Office of the Chief Naval Operations Instruction
OSHA	Occupational Safety and Health Administration
PE	professional engineer
PPE	personal protective equipment

July 2017

QP qualified person

RAC risk assessment code

RRR relative risk ranking

SRD self-retracting device

## 1. INTRODUCTION

CJSeto Support Services, LLC, (CJS) was contracted by Naval Facilities Engineering Command Southwest (NAVFAC SW) to identify fall hazards associated with Navy personnel from Squadron HSM-40 performing maintenance duties on MH-60 helicopters in the northeast and southwest bays of Hangar 1552, at the wash-down apron, and on the flight line at Naval Base Mayport, in Mayport, Florida. The hazards of interest are situations in which personnel would be in danger of sustaining injuries by falling from heights greater than 4 ft. without proper fall protection. CJS also performed a fall hazard survey related to MH-60 maintenance, as defined in Office of the Chief Naval Operations Instruction 5100.23G, Chapter 13, and referenced in the Department of the Navy Fall-Protection Guide.

This hazard analysis report (HAR) provides a thorough description of fall hazards, validation of the hazardous conditions, evaluation of the risk posed by the hazards, possible mitigation strategies, and recommended solutions for Navy personnel who perform maintenance duties on MH-60 aircraft at these locations. Hazard identification data sheets providing details of the hazard areas are included in Appendix A. A draft procurement specification, including design and performance requirements for the recommended solution, is provided as Appendix B. Vendor information sheets for each of the solutions evaluated are included in Appendix C.

### 1.1 Background

Naval Station Mayport, Florida, is one of three major Navy installations in the larger Jacksonville, Florida, area. The station is unique in that it is home to a busy seaport as well as an air facility. The base itself is located at the mouth of the St. Johns River and the Atlantic Ocean near the small fishing village of Mayport and Atlantic Beach.

Since its commissioning in December 1942, Naval Station Mayport has grown to become the third-largest fleet concentration area in the United States. Mayport's operational composition is unique, with a busy harbor capable of accommodating 34 ships and an 8,000-foot runway capable of handling any aircraft in the Department of Defense inventory.

With more than 3,400 acres, the naval station is host to more than 70 tenant commands, including 19 naval ships; the U.S. Coast Guard ship Valiant (WMEC 621); Helicopter Maritime Strike Squadrons (HSM) 46 and 48, and Helicopter Anti-Submarine Squadron Light 60; and HSM 40, the subject of this fall hazard assessment.

HSM-40 is one of two MH-60R Fleet Replacement Squadrons. HSM-40 instructors train pilots and aircrew of the U.S. Atlantic Fleet, along with foreign students from around the world. The students train in Naval Aviation's premier rotary wing anti-submarine weapon system, the MH-60R "Seahawk" helicopter.

Figure 1 shows an aerial view of the station.

## 1.2 Purpose

The purposes of this HAR are to: (1) identify fall hazards as they relate to aircraft maintenance performed in Hangar 1552, at the aircraft wash-down apron, and on the flight line; (2) determine the most effective way to control the fall hazards identified; and (3) provide a cost/benefit trade-off analysis and performance specifications for implementing the mitigation strategies.



Figure 1. An aerial view of Naval Station Mayport, Florida (photo: U.S. Defense Imagery). The aircraft runway and large rectangular flight line area are visible to the right of the main loch. Hangar 1552 is located left of the flight line.

## 1.3 Approach

The hazard analysis followed the steps outlined below:

1. The site was visited to obtain an understanding of actual operations and maintenance procedures by meeting with the local safety personnel, operators, and maintenance personnel.

July 2017

2. Potential fall hazards were identified as related to maintenance of the MH-60 aircraft.
3. Solutions for controlling the fall hazards were evaluated with respect to the governing fall protection codes and procedures, as set forth in the pertinent OPNAVINST.
4. For each hazard identified, a risk assessment was performed to help identify and prioritize the hazards for decision-makers to use in implementing the proposed solutions.
5. Cost/benefit trade-off analyses were performed for the proposed solutions.
6. Recommendations were provided for the most advantageous control measures as well as the related cost impacts for each recommended control measure.

## 2. HAZARD IDENTIFICATION AND EVALUATION METHODOLOGY

The assessment team consisted of Jake Williams, P.E., and John Blake, both certified as fall protection competent and qualified persons. The team visited Naval Station Mayport in May 2016 to conduct a site assessment of the fall hazards associated with maintenance being performed on MH-60 aircraft by HSM-40. The visit was under the direction of Brian Moses, HSM-40 Safety and Occupational Health Specialist, as well as HSM-40 safety personnel Lieutenant Hector Ferrell and Master Chief Aviation Ordnanceman Kevin Nowlin. The squadron's written fall protection program was also evaluated as part of the assessment and is discussed in Section 3, Programmatic Evaluation. The results of the hazard survey and subsequent analysis are identified and discussed in Section 4, Hazards and Recommendations Discussion. The following subsections describe the approaches to identifying the hazards, assigning a risk assessment code (RAC) and relative risk ranking (RRR) for the identified hazards, and developing the proposed solutions.

### 2.1 Validation of Fall Hazards

The fall hazards identified related to routine aircraft maintenance activities were evaluated in relation to applicable Occupational Safety and Health Administration (OSHA) requirements. The evaluation of fall hazards was limited to situations in which a person could fall 4 feet or more and was performed in accordance with guidelines presented in the Department of the Navy Fall-Protection Guide, May 2015; Navy Safety and Operational Health Program Manual, OPNAVINST 5100.23G; 29 Code of Federal Regulations (CFR) 1910 and 1926; and "Fall Protection Code," American National Standards Institute (ANSI) Z359. The Navy Fall-Protection Guide states that, in accordance with OPNAVINST 5100.23G,

"Fall protection must be provided to Navy civilians and military personnel exposed to fall hazards on any elevated walking working surface with unprotected sides, edges, roofs, or floor opening, from which there is a possibility of falling four feet or more (5 feet for Shipyard Operations) to a lower level; or where there is a possibility of a fall from any height onto dangerous equipment, into a hazardous environment, or onto an impalement hazard."

Fall hazards with unprotected sides where workers are at heights greater than 4 feet from the ground occur during maintenance operations on the tops of wings, fuselages, and tails of MH-60 aircraft in the two bays of Hangar 1552, at the wash rack, and on the flight line.

### 2.2 Risk Assessment

For each hazard identified, a risk assessment was performed to help identify and prioritize the hazards for decision-makers to consider in implementing the proposed solutions. The risk assessment included determining the associated degree of risk in terms of probability and

July 2017

severity according to OPNAVINST 3500.39C, "Operational Risk Management," as shown in Table 1 and Table 2. The values for each of these variables were then used to determine a RAC for each hazard. Table 3 is a guideline matrix used to assist in assigning RACs.

Table 1. Probability categories.

Category	Description
A	Likely to occur immediately or within a short period of time. Expected to occur frequently to an individual item or person, or continuously over a service life for an inventory of items or group.
B	Probably will occur in time. Expected to occur several times to an individual item or person, or frequently over a service life for an inventory of items or group.
C	May occur in time. Can reasonably be expected to occur sometime to an individual item or person, or several times over a service life for an inventory of items or group.
D	Unlikely to occur but not impossible.

Table 2. Severity categories.

Category	Description
I	Loss of the ability to accomplish the mission. Death or permanent total disability. Loss of a mission-critical system or equipment. Major facility damage. Severe environmental damage. Mission-critical security failure. Unacceptable collateral damage.
II	Significantly degraded mission capability or unit readiness. Permanent partial disability or severe injury or illness. Extensive damage to equipment or systems. Significant damage to property or the environment. Security failure. Significant collateral damage.
III	Degraded mission capability or unit readiness. Minor damage to equipment, systems, property, or the environment. Minor injury or illness.
IV	Little or no adverse impact on mission capability or unit readiness. Minimal threat to personnel, safety, or health. Slight equipment or systems damage but fully functional and serviceable. Little or no property or environmental damage.

Table 3. Risk assessment matrix.



July 2017

Risk Assessment Matrix			Probability				
			Frequency of Occurrence over Time				
			A Likely	B Probable	C May	D Unlikely	
Severity	Effect of Hazard	I	Loss of Mission Capability, Unit Readiness or Asset; Death	1	1	2	3
		II	Significantly Degraded Mission Capability or Unit Readiness; Severe Injury or Damage	1	2	3	4
		III	Degraded Mission Capability or Unit Readiness; Minor Injury or Damage	2	3	4	5
		IV	Little or No Impact to Mission Capability or Unit Readiness; Minimal Injury or Damage	3	4	5	5
Risk Assessment Codes							

1 = Critical	2 = Serious	3 = Moderate	4 = Minor	5 = Negligible
--------------	-------------	--------------	-----------	----------------

### 2.3 Relative Risk Ranking

An RRR was developed for the identified hazards related to the MH-60 maintenance performed by HSM-40. The objective of the RRR is to compare the identified hazards to aid in establishing priorities for implementation of fall hazard control measures. The RRR for a hazard is a probabilistic calculated value that considers the severity of the potential fall, the frequency of exposure to the hazard, the number of places the hazard occurs, the proximity of the worker to the hazard, the duration spent near the hazard, the effect of other workers in the area, the effectiveness of fall protection measures that are in place, the walking/working surface, and the environment in which the work is performed. Other factors that cannot be easily measured or accounted for are assumed to uniformly influence the risk and consequences of a fall. This assumption allows a relative (as opposed to absolute) risk ranking.

A discussion of the ranking results is provided in Section 4.2, Hazard Analysis.

### 2.4 Mitigation Strategies

Mitigation strategies were identified and developed for each fall hazard situation. The strategies were developed and evaluated from a safety perspective according to the "Preferred Order of Control Measures," as presented in the Department of the Navy Fall-Protection Guide.

Mitigation strategies outlined in this hazard analysis are based on five unique strategies for controlling fall hazards, proceeding from eliminating the hazard to using fall arrest equipment. For example, the first and preferred step, or strategy, is to try to eliminate the hazard; however, some situations were noted during the assessment where the use of personal

protective equipment (PPE) was a more practical solution. Full descriptions of the five hazard mitigation strategies and associated priority rankings are shown in Table 4.

Table 4. Mitigation strategies for fall hazard.

Priority (high to low)	Mitigation	Description
1	Elimination	A redesign or procedural change that eliminates exposure to a fall hazard, e.g., lowering the task to ground level.
2	Prevention	An approach where workers are physically separated from a fall hazard through the use of barriers, e.g., installing guardrails at an opening or edge.
3	Engineering controls	An approach used if the hazard cannot be eliminated, isolated, or separated from the worker, e.g., a change in design, equipment, or techniques, such as the use of an aerial lift or movable and stationary work platforms.
4	Administrative controls	An approach in which new work practices are developed in order to reduce the risk that a worker will fall, e.g., erecting warning lines or limiting access to hazardous areas.
5	Personal protective systems and equipment	This approach is used when none of the above control measures are practical to implement or when a secondary fall protection system is needed, e.g., requiring workers to use a fall restraint system in addition to erecting warning lines.

### 3. PROGRAMMATIC EVALUATION

#### 3.1.1 Requirements Flowdown

Requirements for implementation of a fall protection program and protection of workers from falls while ashore and working at heights greater than 4 ft. derive ultimately from the *Navy Safety and Occupational Health Program Manual* (OPNAVINST 5100.23G). Fall protection is addressed in Chapter 13. The policy, as directed in Section 1303, states:

Every command, work center, and unit shall have a safety culture with management commitment that promotes a safe work environment for personnel working at heights. The Regional Commander, Commanding Officer/Director, Officer-In-Charge of the Navy Activity is responsible for establishing and implementing a fall protection program, which includes identification and elimination/control of fall hazards. Navy activities are responsible for: assigning responsibilities; surveying and assessing fall hazards; providing prevention and control measures; training of personnel; inspecting the equipment; auditing and evaluation; proper installation and use of fall protection systems; and the availability of rescue equipment with accompanying rescue procedures. Fall protection must be provided to Navy civilians and military personnel exposed to fall hazards on any elevated walking working surface with unprotected sides, edges, or floor openings, from which there is a possibility of falling four feet (five feet for Shipyard Operations) or more to a lower level; or where there is a possibility of a fall from any height onto dangerous equipment, into a hazardous environment, or onto an impalement hazard (OPNAVINST 5100.23G).

In implementing this policy, Section 1304 states that each Navy activity is required to establish and maintain a fall protection program. The activity either may opt to develop and maintain an activity-specific written fall protection program or may state, in writing, that the activity is using the Navy Fall-Protection Guide as its fall protection program. In either case, the basic requirements for the fall protection program set out in both OPNAVINST 5100.23G and the Navy Fall-Protection Guide are required to be met.

These requirements include:

- Activity policy
- Duties and responsibilities
- Fall hazard prevention and control, including the preparation of fall protection and prevention plans
- Training
- Inspection, storage, care, and maintenance of fall protection equipment
- Rescue procedures
- Audits and evaluations.

The Navy Fall-Protection Guide delineates the general applicability of OSHA standards for fall protection. In general, the requirements of 29 CFR 1910 for general industry are invoked for Navy and Navy-employed personnel. The requirements of 29 CFR 1926 and EM-385.1.1 (U.S. Army Corps of Engineers 2008) are invoked for construction work for contractors only. Finally, invoked by reference are the requirements specified in the ANSI/ASSE Standards Z359, “Fall Protection Code”; A1264.1, “Safety Requirements for Workplace Walking/Working Surfaces and Their Access; Workplace, Floor, Wall and Roof Openings; Stair and Guardrail Systems”; and A14.3, “Safety Requirements for Fixed Ladder and Workplace Surfaces.”

### **3.1.2 HSM-40 Programmatic Observations**

The CJS team interviewed Mr. Moses, HSM-40 Safety and Occupational Health Specialist, regarding the activity’s written fall protection program. Mr. Moses informed the team that he was aware of deficiencies within the program and was working to correct them. An outdated policy that was being used as a basis for the new draft and a binder containing training logs, equipment inspections records, and equipment inspection manuals were shown to the team. The appropriate information appeared to be within the binder regarding training and equipment inspection logs, but with improved organization the binder could provide a better resource to identify training requirements and whether those requirements have been met. Fall protection equipment storage location and requirements and the process for checking out equipment prior to use should also be specified within the written program in addition to the inspection logs that were provided.

It was noted that end-user training was tracked in the Advanced Skills Management (ASM) system, and logs were printed from this system to be kept in the binder. Having just recently filled the position within the HSM-40 fall protection program, Mr. Moses had not yet been able to take the required Fall Protection Program Manager (PM) and Competent Person (CP) courses needed for his position. It was also noted that these training requirements are not entered in the ASM system and would not be automatically tracked. It was recommended to add Program Manager and Competent Person training tracking to ASM if possible.

Other deficiencies in the program included the lack of a workplace survey and general or site-specific fall protection and prevention plans. This HAR helps fulfill the requirements for the survey and presents possible options for the site-specific fall protection and prevention plans identified in Section 5.1, Recommended Mitigation Strategy; however, further decisions by the squadron will need to be made to determine the actual mitigation solutions that will be implemented and followed by maintenance personnel.

## 4. HAZARDS AND RECOMMENDATIONS DISCUSSION

### 4.1 Hazard Description

Hangar 1552 consists of two separate bays occupied by MH-60 aircraft maintained by HSM-40 personnel (Figure 2). The bays are separated by a large, two-deck, parts and supply cage. A two-rail bridge crane crosses the southwest portion of the hangar bay.

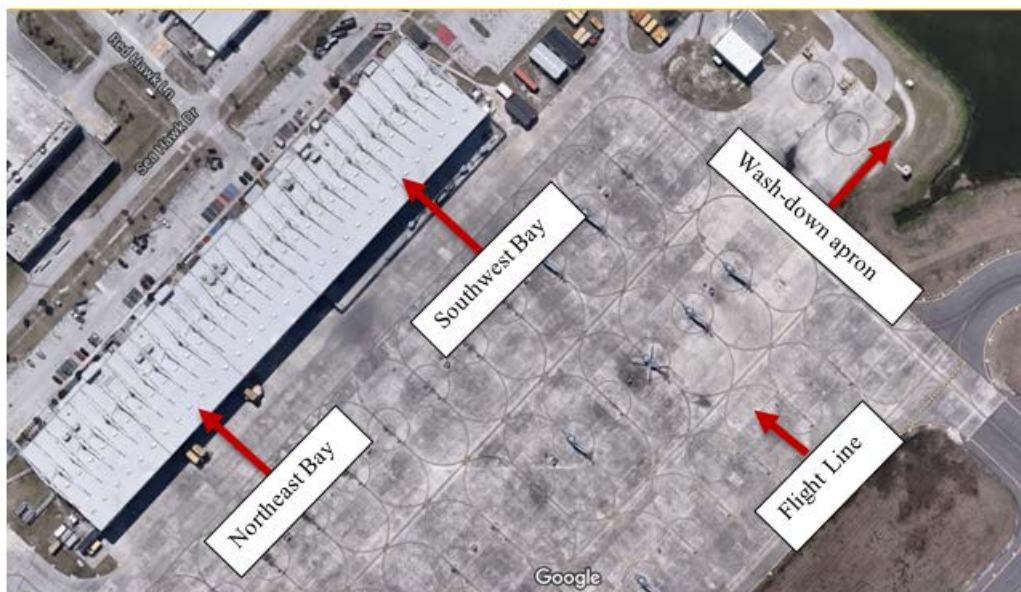

Figure 2. The northeast and southwest bays of Hangar 1552, the wash-down apron, and flight line at Naval Station Mayport.

HSM-40 had 20 MH-60s at the time of the assessment, and it was noted that there would likely be four additional aircraft by the end of 2017. Fifteen of the aircraft are typically active at any given time with the others being located in the hangar for in-depth phase and regularly scheduled maintenance. As many as five helicopters may be worked on at a time, although under normal operations the number is two or three, as was the case during the assessment. Maintenance of the MH-60s can be grouped into four categories:

1. Maintenance of the aircraft at the tail
2. Maintenance of the aircraft fore of the main rotor
3. Maintenance of the aircraft aft of the main rotor
4. Washing of the aircraft at the wash-down apron.

A hazard sheet was compiled for each of these categories to detail number of workers, potential fall height, frequency of access, and other factors that can help evaluate the risk associated with the respective work evolutions. Possible individual solutions are also provided



in the sheets and are discussed in Section 5, Conclusion. These hazard sheets can be found in Appendix A. Typically one or two workers are positioned on top of the MH-60s in each instance; however, up to six workers may be located on top of the aircraft for the main rotor maintenance.

A large portion of the hangar maintenance needs for the MH-60 are accessible via work stands currently used by the maintenance workers; however, a majority of the Blue Webb-Rite wrap-around maintenance stands are in disrepair, have missing hardware, and have areas of severe corrosion (Figure 3). The command has pieced together one workable complete set that still presents fall hazards in certain areas (aft of engine compartments) due to the stand not conforming completely to the shape of the aircraft. Having only one complete wrap-around maintenance stand results in unmitigated fall hazards while maintenance is performed on other aircraft. Work on top of the aircraft fore and aft of the main rotor is being performed without the use of any fall protection on multiple aircraft since only one stand is available.

Personnel are also currently using B-4 stands along the side of the MH-60 tail rotor, but the end guard rail is removed and the swing gate is taped open (Figure 4) in order to rotate the blades during maintenance, which exposes the personnel to a fall of greater than 7 feet. Personnel were also observed accessing the tail of the aircraft and working from pylon steps integral to the aircraft. No other means of fall protection were noted during these work activities.



Figure 3. Corrosion issues noted on Blue Webb-Rite work stands.



Figure 4. B-4 stand with swing gate taped open and no end rails used for access to the tail rotor. Work on top of the aircraft with no fall protection aft of the main rotor can also be seen.

The wash-down apron is equipped with four Webb-Rite Overhead Rigid Rail Systems that are severely corroded (Figure 5) from the corrosive soap used to wash the aircraft and from exposure to the elements. CJS personnel were told that after the rail systems were removed from service (approximately 4+ years prior to the assessment) the blue maintenance stands were pushed back and forth to the wash rack to assist with the washing; however, it was reportedly noted that pushing the stands over the hangar door rails was damaging the casters on the stands. Currently, maintenance personnel are using a B-4 stand to access the top of the aircraft and then continue washing the aircraft without the use of any fall protection (Figure 6, left). When workers were asked about the telescoping brush poles noted at the wash rack (Figure 6, right), CJS personnel were told that the workers still needed to access the top of the aircraft to reach certain areas during washing and could not reach all areas or apply the needed scrubbing pressure while standing on the B-4 stands.

Maintenance performed on the flight-line was also observed being performed without the use of any fall protection.





Figure 5. Corrosion issues noted on Webb-Rite Overhead Rigid Rail Systems located at the wash rack.



Figure 6. B-4 stand observed at the wash rack to access and wash the top of the aircraft (left) and telescoping brush poles (right).

Since multiple B-4 stands were available, the stands were evaluated for use during maintenance of the aircraft. Issues noted by CJS regarding use of the B-4 stands during work on the H-60s include the following:

- The stands are not adequate since they are not long enough to reach the portion of the aircraft requiring attention.
- The stands do not accommodate the curvature of the aircraft present on the Romeo variant that is equipped with lateral protuberances.
- The stands do not provide full 360-degree protection around the work area when workers need to get on top of the aircraft.

Due to these shortcomings, the B-4 stands were determined to not provide adequate fall protection by themselves during maintenance on the H-60s.

## **4.2 Hazard Analysis**

According to “Introduction to Operational Risk Management,” OPNAVINST 3500.39C, the hazard severity for each of the hazard areas identified is a Category I and the mishap probability is Sub-category B. This means that the fall hazards associated with the aircraft maintenance activities in Hangar 1552, the aircraft wash-down apron, and the flight line at Naval Station Mayport may cause a death and that such an accident could occur in the near future. The occupational safety rules regarding falls from heights of 4 feet or higher are based on the fact that a death can occur from a fall from such heights. Considering the frequency at which workers are exposed to fall hazards while maintaining aircraft without fall protection, which is daily, such an accident could occur in the near future. Additionally, falls have already occurred in the past during such operations, although the injuries sustained have been relatively minor. Personnel noted that during the latter part of 2014 the caster wheels on a stand did not get locked and the stand pushed away from the aircraft resulting in the fall of a maintenance worker. It was also reported that since May 2014, two workers had fallen off the main engine covers.

To help prioritize the four areas of concern in relation to the level of risk associated with the maintenance, an RRR was assigned to each area, as described in Section 2.3, Relative Risk Ranking. Table 5 shows each area and the corresponding RRR. The highest risk calculated is associated with maintenance at the tail rotor. This is primarily due to the work currently being performed on vertical surfaces (i.e., pylon steps or improper ladder use observed). The risk associated with work fore of the main rotor is similar to that associated with work aft of the rotor due to similar working platforms and frequency of maintenance. The risk associated with washing aircraft is lessened due to the lesser frequency and duration of the washing compared to the nearly continuous maintenance of the aircraft.

Table 5. Areas of concern for fall hazards related to maintenance of MH-60 aircraft.

Hazard ID	RAC	RRR	Work Location
H-1	1	12.6847	MH-60 tail maintenance
H-2	1	9.4229	MH-60 maintenance fore of the main rotor
H-3	1	9.3436	MH-60 maintenance aft of the main rotor
H-4	1	8.4942	Washing aircraft at the wash-down apron

### 4.3 Mitigation Strategies Evaluated

The following six strategies were evaluated as possible options for resolving the fall hazards associated with performing maintenance duties on MH-60 aircraft in Hangar 1552, at the aircraft wash-down apron, and on the flight line at Naval Station Mayport. The strategies are presented in the order of preference as specified in Section 2.4, Mitigation Strategies.

1. Maintenance stands (i.e., Control Measure #2. Prevention, and #3. Engineering Controls). Maintenance stands with guard rails are strategically placed around aircraft for workers to stand on during maintenance activities, eliminating the fall hazard (Figure 7). Stands are specifically designed to conform to the contour of the aircraft.

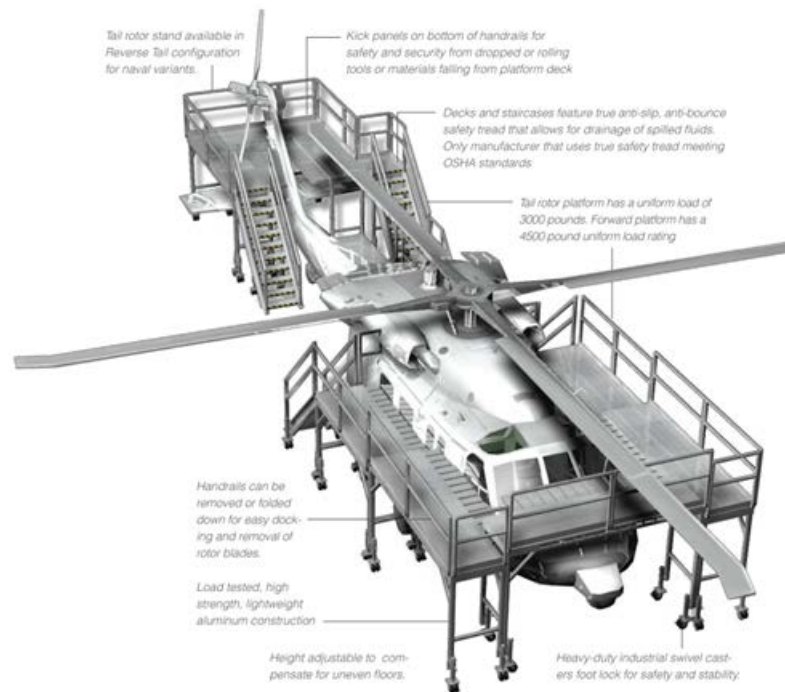

Figure 7. Illustration and features of maintenance stands with guard rails for fall protection during work on aircraft within Hangar 1552.

July 2017

2. *Little Giant® safety cage ladder* (i.e., Control Measure #2. Prevention, and #3. Engineering Controls). The ladder incorporates a platform that provides guard rails to protect personnel in the performance of their maintenance duties (Figure 8).



Figure 8. Little Giant® safety cage ladder next to the tail of an MH-60.

3. Fixed, overhead rail system (I-beam clamp and self-retracting devices [SRDs]) (i.e., Control Measure #5. Personal Protective Systems and Equipment). Anchor points for fall arrest equipment attach to a trolley that rolls along an existing overhead beam or to a fixed anchor point attached to a beam (Figure 9).
4. *Tie-back lanyard or anchor strap and adjustable-length lanyard for restraint*. (i.e., Control Measure #5. Personal Protective Systems and Equipment). The main rotor becomes the anchor point for restraint. Personnel would connect a lanyard (tie back or adjustable length) to a harness that would physically prevent them from falling off the top of the aircraft. This solution can be used in the hangar as well as along the flight line (Figure 10).



Figure 9. Overhead rail with mobile anchor point (left). An SRD (right) attaches to the anchor point.

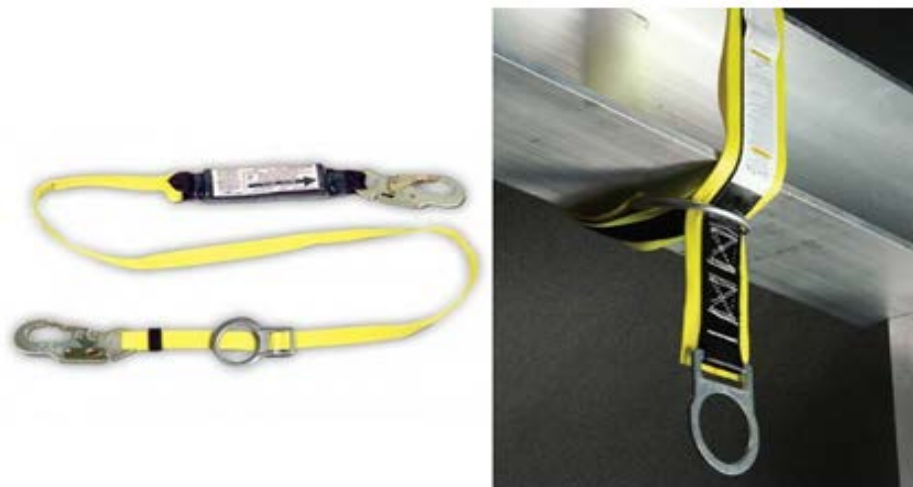

Figure 10. Examples of tie-back lanyard (left) and anchor strap (right).

5. A *mobile, horizontal rail system* (i.e., Control Measure #5, Personal Protective Systems and Equipment). Anchor points for fall arrest equipment attach to a trolley that rolls along a horizontal rail, which is located above the worker. Can be adjustable or fixed height (Figure 11).





Figure 11. Examples of mobile, horizontal rail systems.

6. Wash rack facility (i.e., Control Measure #3. Engineering Controls, and #5. Personal Protective Systems and Equipment). Anchor points for fall arrest equipment attach to a trolley that rolls along a fixed overhead horizontal rail (Figure 12).



Figure 12. Wash rack facility.

#### **4.4 Cost/Benefit Trade-Off Analysis**

An alternatives analysis (Table 6) was performed to compare advantages and disadvantages of the solutions summarized in the previous section. Preliminary costs for procurement, installation, assembly, and operability verification were estimated for the purpose of determining the relative costs of the various alternatives. This analysis has been developed in such a way that the entire analysis, essentially the contents of this entire assessment, is condensed into a single table. This allows the Navy to re-visit the alternatives analysis with ease and use the table as a tool for a working meeting among stakeholders to discuss the alternatives, make final selections, and move forward with procurements.

Additionally, a scoring matrix (Table 7) has been developed to facilitate quantitative input into the decision-making process. Table 7 assumes five primary concerns that stakeholders may have in making a final selection. These five areas have been weighted according to perceived interests of Navy stakeholders.

CJS has taken into consideration all of the information in the alternatives analysis and has used the scoring matrix and its assumptions as guidance in providing the final recommendations. CJS highly recommends that the Navy coordinate an alternatives analysis meeting in which all stakeholders take part in selecting a solution with the aid of Tables 6 and

7. This would allow all stakeholders—from project managers to engineers to safety personnel—the opportunity to voice opinions and discuss the variety of advantages, disadvantages, costs, and issues associated with implementation, procurement, operations, and safety.



DEPARTMENT OF THE NAVY FALL PROTECTION GUIDE

July 2017

Table 6. Analysis of fall protection alternatives for maintenance atop aircraft in Hangar 1552 at Naval Station Mayport.

Options	Advantages	Disadvantages	Cost
1. Maintenance stands	Portable equipment that has quick setup. It can be rolled/moved by hand to desired location.	Due to limited storage space, it would be difficult to find places to store access stands when not in use.	Off-the-Shelf Equipment Cost: \$85,000 for MH-60 stand
	After it is set up, equipment can be left in place until all required maintenance is completed.		Freight and Set-up Cost: \$6,000
	Easily protects personnel accessing aircraft via OSHA-compliant built-in stairway.	Stands could bump aircraft, creating damage.	Maintenance Cost: Performed at the receiving authority
	Since fall hazard is eliminated, no fall protection training is required. No personal protective equipment needed.	Might be difficult to maneuver equipment around hangar due to obstacles and limited space between aircraft.	Installation Cost: Included in Freight
	Stands allow for platform to be adjusted to conform to the shape of the aircraft.	The number of aircraft in the hangar would be limited due to the amount of space required.	Training Costs: N/A
	Personal protective equipment will not become entangled in rotors of aircraft.	Not feasible for use on the flight line or wash rack.	<b>Total Approximate Implementation Cost per System: \$91,000</b>
	Stands can be maintained and inspected by site personnel after initial vendor training.		
2. Little Giant® safety cage ladder	Portable equipment that has quick setup. It can be rolled/moved by hand to desired location and has an adjustable height.	Potential to be misused similar to other ladders. Potential tipover due to working perpendicular to the platform rather than in line with the legs of the ladder.	Off-the-Shelf Equipment Cost: \$2,000 (for 5-ft to 9-ft-tall model)
	No additional training would be required outside of normal ladder safety.	Working area reach is limited by the small platform.	Transportation Cost: Included
	Fits in narrower access points on airframe.	Worker(s) must get down from aircraft to reposition.	Installation Cost: N/A
	Easily protects personnel accessing aircraft via OSHA-compliant built-in stairway and guardrails around the platform.	Multiple movements would be needed to access aircraft, creating possibility of bumping (and damaging) aircraft.	Maintenance Cost: Performed at the receiving authority
	Already have several ladders onsite.	Potential pinch hazards while adjusting the ladder.	Training Costs: N/A
	Can be used in the hangar or outside on flight line or wash rack.		<b>Total Approximate Implementation Cost for a Single Unit: \$2,000</b>
3. Fixed, overhead rail system (I-beam clamp and SRDs)	Protects personnel accessing aircraft because the worker can attach the SRL at ground level and access heights while tied-off.	System provides fall protection for a limited number of people at a time, and is limited to the locations of the existing structural beams.	Off-the-Shelf Equipment Cost: \$1,100 (includes I-beam clamp and 50-ft SRD)
	Allows essentially full freedom of motion for the worker during maintenance activities.	The solution requires the worker to wear fall arrest PPE to mitigate the fall hazard. This form of active fall protection is not as effective as hazard elimination, prevention or engineering controls.	Transportation Cost: Included
	Will not take up valuable floor space, or interfere with movement of jets or equipment.	If multiple workers were on the aircraft simultaneously, movement would be limited since it would be difficult to cross from one side of a fellow worker to the other.	Installation Cost: \$1,100 for "first-man-up" system or installation by personnel with a bucket truck or scissor lift.
	Designed correctly, the risk of swing falls is eliminated.	Structural analysis of existing hangar would need to be performed to determine if existing structure could withstand the additional load.	Maintenance Cost: Inventory and inspect equipment, care and storage performed at the receiving authority
	Relatively simple to use, requiring less training time.	Due to a bridge crane that runs down the center of the building, fixed overhead rail system would require additional administrative control procedures.	Training Costs: Command Competent Persons for Fall Protection can train workers in proper use of fall protection equipment
		Can be used only inside the hangar.	
4. Tie-back lanyard or anchor strap and adjustable-length lanyard for fall restraint	Easier to inspect and place back into service than a horizontal lifeline.	PPE could become entangled with rotors on H-60 aircraft.	<b>Total Approximate Implementation Cost per System: \$2,200 (only \$1,100 for additional anchor systems)</b>
	Will not take up valuable floor space, or interfere with movement of aircraft or equipment.	System provides fall protection for a limited number of people at a time on the same aircraft.	Off-the-Shelf Equipment Cost: \$200 (cost includes tie-back lanyard or anchor strap and lanyard)
	Implemented correctly, the risk of falling is nearly eliminated.	The solution requires the worker to wear fall arrest PPE to mitigate the fall hazard. This form of active fall protection is not as effective as fall restraint, engineering controls, or hazard elimination.	Transportation Cost: Included
	Relatively simple to use, requiring less training time.		Installation Cost: N/A
	Reduces the number of stands needed and does not require large storage spaces.	If multiple workers were on the aircraft simultaneously, movement would be limited since it would be difficult to cross from one side of a fellow worker to the other.	Maintenance Cost: Inventory and inspect equipment, care and storage performed at the receiving authority
	Workers can quickly set up the system and remove when complete without adding a significant amount of time to the maintenance tasks.	Structural analysis of existing hangar would need to be performed to determine if existing structure could withstand the additional load.	Training Costs: Performed by the receiving authority
	Low cost solution and could feasibly be provided for as many aircraft as necessary.		<b>Total Approximate Implementation Cost per System: \$200</b>
5. Mobile horizontal rail system	Portable equipment that has quick setup. It can be rolled/moved by hand or pulled with a hitch attachment to desired location.	The solution requires the worker to wear fall arrest PPE to mitigate the fall hazard. This form of active fall protection is not as attractive as fall restraint, engineering controls, or hazard elimination.	Off-the-Shelf Equipment Cost: \$18,000 (cost includes all required SRLs, harnesses, and taglines)
	Fits main section of aircraft.	Swing falls are possible when the worker is tied-off to the horizontal rail, because he or she can walk away from the end of the rail. This would require administrative controls (training) to protect against it. It is possible to slightly protect against swings by shortening the SRL, but the typical way to protect against swing falls is through training. In this case, it is ideal to attach the SRL to the worker while on the ground; this requires a longer SRL, but the longer SRL makes it difficult to protect against swing falls.	Transportation Cost: \$2,000
	Protects personnel accessing aircraft because the worker can attach the SRL at ground level and use B-1 or B-4 stands or a scissor lift to access heights while tied-off.	Worker(s) must get down from aircraft to reposition.	Installation Cost: Included
	Horizontal rail system reduces swing fall risk.	Placement of horizontal rail could bump aircraft, causing damage.	Maintenance Cost: Performed by the receiving authority
	Essentially allows the worker full freedom of motion during maintenance work.	Would be extremely difficult to maneuver equipment around hangar due to obstacles and limited space between aircraft.	Training Costs: Command Competent Persons for Fall Protection can train workers in proper use of fall protection equipment
		Number of personnel doing maintenance on top of the aircraft simultaneously would have to be limited.	
	Several mobile horizontal rail systems may be available for repositioning from Naval Air Station Jacksonville.	Limited storage space. Would be difficult to find places to store equipment when not in use.	<b>Total Approximate Implementation Cost for a Single Unit: \$20,000</b>
	PPE could become entangled with rotors on H-60 aircraft.		

DEPARTMENT OF THE NAVY FALL PROTECTION GUIDE

July 2017

Options	Advantages	Disadvantages	Cost
6 Wash rack facility	Protects personnel accessing aircraft because the worker can attach the SRL at ground level and access heights while tied-off	The solution requires the worker to wear fall arrest PPE to mitigate the fall hazard. This form of active fall protection is not as effective as fall restraint, engineering controls, or hazard elimination.	Installed Equipment Cost: \$420,000
	Allows essentially full freedom of motion for the worker during maintenance activities.		Transportation Cost: Included
	Can be custom designed to fit the length of the aircraft.	If multiple workers were on the aircraft simultaneously, movement would be limited since it would be difficult to cross from one side of a fellow worker to the other. The more expensive, parallel rail systems would be needed.	Installation Cost: Included
	Designed correctly, the risk of swing falls is eliminated.	Lengthier and costlier design/procurement phase than ordering equipment "off the shelf"	Maintenance Cost: Performed by the receiving authority
	Relatively simple to use, requiring less training time.	Permanent structure so it may not fit future airframes if mission needs change.	Training Costs per Squadron. Command Competent Persons for Fall Protection can train workers in proper use of fall protection equipment
	Does not have to be pushed close to the aircraft, thus reducing the potential for damage.	PPE could become entangled with rotors on H-60 aircraft	Total Approximate Implementation Cost per System: \$420,000 Total Cost after 10 Years: \$420,000

Table 7. Scoring matrix aiding in selection of solution.

Main Options	Operations Benefits (10%)	Fall Hazard Mitigation (30%)	Forecasted Ability to Meet Future Needs (20%)	Cost (30%)	Ease of Implementation (10%)	Weighted Total
1. Maintenance stands	4	4	3	2	3	3.1
2. Little Giant® safety cage ladder	3	3	3	3	4	3.1
3. Fixed, overhead rail anchor points (I-beam clamp and SRDs)	3	2	4	4	4	3.3
4. Tie-back lanyard or anchor strap and adjustable-length lanyard for fall restraint	3	2	3	5	5	3.5
5. Mobile horizontal rail system	4	2	5	2	3	2.9
6. Wash rack facility	5	2	4	1	3	2.5

Note: Scores were chosen from a range of 1 to 5, where 5 is the highest score (for cost this would reflect a lower dollar value).

## 5. CONCLUSION

### 5.1 Recommended Mitigation Strategy

Due to the varying means of access and work configurations, a combination of the different mitigation strategies will likely be needed to effectively protect the workers while still allowing them to perform their maintenance activities. Based on the hazard assessment and discussion in the previous section, CJS recommends implementation of the fall protection solutions listed for the respective locations below. Potential alternative means of procurement for a few pieces of equipment were identified by both the assessment team and HSM-40 personnel. Two mobile, horizontal rail systems that are in near-new condition and an MH-60 wrap-around stand needing new hardware and minor repairs have been identified as possibly being available for repurposing from Naval Air Station (NAS) Jacksonville.

#### 1. Hangar Bay Maintenance

- a. Continue use of the pieced-together one good set of Blue Webb-Rite wrap-around maintenance stands, and establish and maintain a life-cycle plan by developing local maintenance requirement cards that include corrosion prevention and treatment as well as replacing the plywood flooring when needed. Modify the stand or—at a minimum—establish an administrative control for the areas on the aft ends, and install a safety chain across the open ends.
- b. Acquire aluminum wrap-around stand from NAS Jacksonville, if possible, by submitting a request to Commander, Naval Air Forces. Contact manufacturer to replace missing parts and complete the stand. Procure two (three if stand is unavailable from NAS Jacksonville) additional full sets of wrap-around stands for use during phase maintenance. The maintenance stands for use on the MH-60 helicopters would provide adequate access to all portions of the aircraft. Each deck is equipped with multiple sliding, self-locking floor panels for a contoured fit to the aircraft, and would provide 360-degree protection around the work area of the aircraft.
- c. When working fore or aft of the main rotor, use a tie-back lanyard or anchor strap around the rotor for fall restraint, particularly when using the Blue Webb-Rite stand as currently configured since a fall is still possible from the front of the aircraft.
- d. Align helicopter in the hangar with overhead I-beams down center. Install anchor point clamps on I-beams with SRDs. The structural acceptability of the roof supports will need to be verified since the drawings were unavailable during the site survey.
- e. Install beam clamps with SRDs on crane I-beam (with approval from the Navy Crane Center) over the tail rotor when performing tail rotor maintenance on foot

pegs. Establish administrative control procedure to lock out/tag out crane when beam clamp/SRD is in use.

- f. Use Little Giant®, or similar, ladder for tail rotor maintenance when possible.

## 2. Wash-down apron

- a. Procure two new mobile horizontal rail systems and repurpose the Webb-Rite mobile horizontal rail systems from VP-30 at NAS Jacksonville, to HSM-40. Establish and maintain a life-cycle plan for the stands by developing local maintenance requirement cards that include corrosion prevention and treatment as well as yearly recertification for the stands.
- b. Incorporate Little Giant®, or similar, safety cage ladders.
- c. Use B-4 stands with telescopic-handled washing equipment.
- d. An alternative solution to the mobile horizontal rail systems would be to submit paperwork to construct a wash rack similar to the one used at NAS Jacksonville, helicopter Hangar 1122.

## 3 Flight Line Maintenance

- a. When working fore or aft of the main rotor, use a tie-back lanyard or anchor strap around the rotor for fall restraint.
- b. B-4 Stands – When guard rails must be removed for maintenance, install safety chains that can be lowered when needed to rotate the tail rotor. Chains could then be put back up in between rotations to provide compliant protection.
- c. Use mobile horizontal rail systems when not in use at the wash-down apron. Establish and maintain a life-cycle plan for Webb-Rite stands by developing local maintenance requirement cards that include corrosion prevention and treatment as well as yearly recertification for the stands.

As previously discussed, it was observed during the assessment that there were stands and rail systems present at Hangar 1552 that were in disrepair due to the lack of an ongoing maintenance plan. It will be critical to develop and establish a life-cycle maintenance plan to avoid degradation of the new equipment and to ensure the longevity of all the equipment procured as part of the recommendations above. For all equipment procured, a life-cycle plan will need to be established and maintained by developing local maintenance requirement

cards that include corrosion prevention and treatment as well as yearly recertification for the stands and rail systems.

Use of some of the solutions provided requires fall protection equipment and associated formal training. An important consideration when implementing fall arrest equipment and training is prompt rescue of a worker who has fallen. Severe injury or death may occur to a worker who remains hanging in a fall arrest harness for an extended period. CJS recommends that HSM-40 safety personnel ensure that (1) a rescue plan and associated equipment are available per the Department of the Navy Fall-Protection Guide, Subsection 10.5, Fall Arrest Rescue Plans and Procedures, and (2) such a plan meets all requirements of 29 CFR 1926.502(d)(20) and applicable sections of ANSI/ASSE Z359.

## 5.2 Cost Summary of Final Recommendation

Table 8 summarizes the specific quantities of the recommended equipment discussed in Section 5.1, Recommended Mitigation Strategy, and the associated cost for mitigation of the fall hazards identified during aircraft maintenance within Hangar 1552, at the wash-down apron, and on the flight line at Naval Air Station Mayport.

Table 8. Summary of recommended solutions.

Location	Recommendation	Quantity	Estimated Equipment Cost*
Hangar 1552	Maintenance stands	3	\$273,000
	Overhead rail anchor points (trolleys for I-beams) and Class B SRDs	14	\$16,500
	Little Giant® safety cage ladders	3	\$6,000
Wash-down Apron and Flight Line	Mobile, horizontal rail system	4	\$80,000
Flight Line	Anchor straps and lanyards	6	\$2,880
Total Cost			\$378,380

\* Equipment cost does not include training or annual maintenance if not performed by the receiving agency.

## 5.3 Potential Cost Savings

The cost estimate shown in Section 5.2. Cost Summary of Final Recommendation, reflects the price if all new equipment is procured. As mentioned earlier in the report, equipment potentially available for repurposing was identified at NAS Jacksonville. There would still be costs associated with repairing, shipping, and recertifying the equipment for use; however, the

cost savings could be significant. Table 9 details the costs identified with repurposing the equipment and the potential overall cost savings to the command.

Table 9. Potential cost savings from repurposing equipment at NAS Jacksonville.

Description of System Potentially Available for Repurposing	Cost of New System(s)	Cost of Repurposing from NAS Jacksonville*	Potential Cost Savings
Mobile, horizontal rail systems (2 systems)	\$40,000	\$33,600	\$6,400
Maintenance stand (1 system)	\$91,000	\$28,000	\$63,000
Total Potential Savings			\$69,400

\* Cost provided is a rough estimate. Manufacturer will need to be contacted for an exact quote prior to performing the work.

## 5.4 Performance Requirements

CJS recommends that the following performance requirements be submitted to potential bidders when requesting proposals or pricing.

### 5.4.1 Performance Requirements for Mobile, Horizontal Rails

- Mobile, horizontal rails shall be adjustable in height with a minimum height of 20 feet with a rail length of approximately 20 feet.
- Horizontal rail systems shall have pneumatic wheels for outside use on asphalt surfaces such that they can travel long distances while being physically pushed by workers.
- Horizontal rail systems shall have tracks capable of allowing two workers to attach at a time.
- Horizontal rail systems' fall protection shall meet all design and testing requirements of the latest revision of ANSI Z359.
- Horizontal rail system must have no metal-to-metal contact with the aircraft.

### 5.4.2 Performance Requirements for Maintenance Stands

- The platform shall be designed for use on an H-60 aircraft.
- The platform shall have OSHA-compliant rails with associated toe-boards on all sides except at entrances to stairways. The guardrails shall completely eliminate the fall hazard by surrounding the aircraft, including eliminating any possibility of falling to the ground between the fuselage and the platform system.
- The rails shall be removable (note that if personnel are situated on stands when rails are removed then personal fall arrest systems may be required).

- OSHA-compliant stairways or ladders shall be provided for gaining access to the platform from the ground. If ladders are used, a self-closing swing gate shall be provided at the ladder opening.
- The platform shall be mobile in any direction via lockable wheels or casters.
- The platforms shall be capable of relocation by hand (pushing or pulling the equipment on level ground).
- The platform design shall meet applicable design load requirements of OSHA regulations for scaffolding.
- Platform system must have no metal-to-metal contact with the aircraft.
- Platform system shall have multiple sliding, self-locking floor panels for a contoured fit to the aircraft.

#### **5.4.3 Performance Requirements for Overhead Rail Anchor Points, SRDs, Anchor Straps, and Lanyards**

- Anchor point shall be capable of being temporarily installed on an existing I-beam without modification to the structure.
- The anchor point shall be capable of rolling or sliding along the beam to remain directly overhead of the worker.
- All equipment shall meet all design and testing requirements of the applicable, latest revision of ANSI Z359.
- Anchor straps shall be of appropriate length and construction to safely attach around the main rotor without damaging the aircraft during maintenance work.
- Lanyards shall be adjustable in length to allow for a proper restraint configuration.

Additional information is included in the draft procurement specification, which is included as Appendix B. Potential vendors are indicated below, and their associated product information is included within Appendix C:

- CAI Safety Systems
- Capital Safety
- Diversified Fall Protection
- Evan Fall Protection
- Fall Protection Systems
- Flexible Lifeline Systems
- Gravitec Systems
- Hy-Safe Technology
- Reliance Fall Protection
- Rigid Lifelines
- Latchways Fall Protection
- Trittech Fall Protection Systems.

The draft procurement specification provided as Appendix B is intended to be used as a starting point for the Navy's procurement process. Information within the specification can be altered to meet the needs of the Navy's procurement process. A successful competitive



July 2017

bidding process would allow vendors flexibility to be creative with the chosen solution as well as allowing vendors to find ways to reduce costs while providing the highest level of hazard mitigation in their proposed equipment.

## 6. REFERENCES

**29 CFR 1910** et seq., “Occupational Safety and Health Standards,” Code of Federal Regulations, online via:  
[www.gpo.gov](http://www.gpo.gov).

**29 CFR 1926** et seq., “Safety and Health Regulations for Construction,” Code of Federal Regulations, online via:  
<http://www.gpo.gov/fdsys/pkg/CFR-2009-title29-vol8/pdf/CFR-2009-title29-vol8-part1926.pdf>.

**ANSI/ASSE A1264.1**, “Safety Requirements for Workplace Walking/Working Surfaces and Their Access; Workplace, Floor, Wall and Roof Openings; Stair and Guardrail Systems,” American National Standards Institute and American Society of Safety Engineers, current revision at the time of this publication.

**ANSI/ASSE A14.3**, “Safety Requirements for Fixed Ladder and Workplace Surfaces,” American National Standards Institute and American Society of Safety Engineers, current revision at the time of this publication.

**ANSI/ASSE Z359**, “Fall Protection Code,” American National Standards Institute and American Society of Safety Engineers, current revision at the time of this publication.

**OPNAVINST 3500.39C**, 2010, “Operational Risk Management,” Department of the Navy, Office of the Chief of Naval Operations, Washington, D.C., July 2, 2010.

**OPNAVINST 5100.23G**, 2011, Navy Safety and Operational Health Program Manual, Department of the Navy, Office of the Chief of Naval Operations, Washington, D.C., July 21, 2011.

**U.S. Army Corps of Engineers, 2008, Safety and Health Requirements Manual (consolidated), EM 385-1-1**, Department of the Army, Washington, D.C., September 15, online via:  
[http://www.publications.usace.army.mil/Portals/76/Publications/EngineerManuals/EM\\_385-1-1\\_2008Sep\\_Consolidated\\_2011Aug.pdf](http://www.publications.usace.army.mil/Portals/76/Publications/EngineerManuals/EM_385-1-1_2008Sep_Consolidated_2011Aug.pdf).

**U.S. Navy, 2015, Department of the Navy Fall-Protection Guide**, Online via:  
[http://www.navfac.navy.mil/content/dam/navfac/Safety/PDFs/fall\\_protection/FALL\\_PROTECTION\\_GUIDE\\_MAY\\_2015.pdf](http://www.navfac.navy.mil/content/dam/navfac/Safety/PDFs/fall_protection/FALL_PROTECTION_GUIDE_MAY_2015.pdf), May 2015.

**END OF THE DOCUMENT**